



INVERTER

FREQROL-CS80

INSTRUCTION MANUAL (DETAILED)

FR-CS84-012 to 295

FR-CS82S-025 to 100

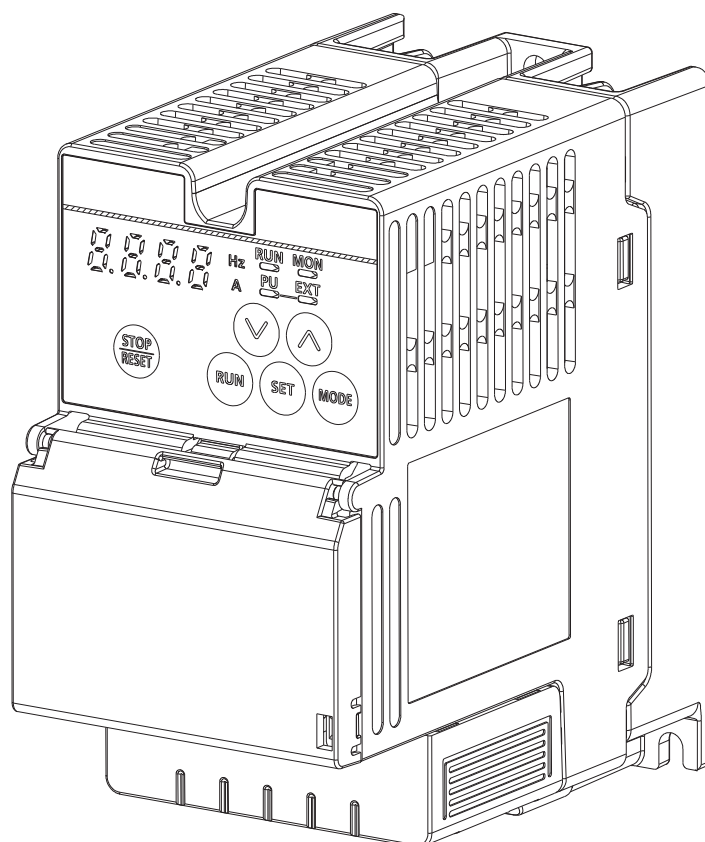

Safety instructions	6
Chapter 1 INTRODUCTION	12
1.1 Product checking and accessories	13
1.2 Component names	14
1.3 About the related manuals.	14
Chapter 2 INSTALLATION AND WIRING	16
2.1 Peripheral devices	16
2.1.1 Inverter and peripheral devices	16
2.1.2 Peripheral devices	18
2.2 Removal and reinstallation of the wiring cover	20
2.3 Installation of the inverter and enclosure design	23
2.3.1 Inverter installation environment	23
2.3.2 Amount of heat generated by the inverter	25
2.3.3 Cooling system types for inverter enclosure	26
2.3.4 Inverter installation	27
2.4 Terminal connection diagrams.	29
2.5 Main circuit terminals	31
2.5.1 Details on the main circuit terminals	31
2.5.2 Terminal layout of the main circuit terminals, wiring of power supply and the motor	31
2.5.3 Applicable cables and wiring length	32
2.5.4 Earthing (grounding) precautions	33
2.6 Control circuit.	35
2.6.1 Details on the control circuit terminals	35
2.6.2 Control logic (sink/source) change	36
2.6.3 Wiring of control circuit	38
2.6.4 Wiring precautions	40
2.7 Communication connectors and terminals.	41
2.7.1 PU connector	41
2.8 Connection of stand-alone option units	42
2.8.1 Connection of the brake unit (FR-BU2).	42
2.8.2 Connection of the high power factor converter (FR-HC2).	44
2.8.3 Connection of the power regeneration common converter (FR-CV).	45
Chapter 3 PRECAUTIONS FOR USE OF THE INVERTER	48
3.1 Electro-magnetic interference (EMI) and leakage currents	48

3.1.1	Leakage currents and countermeasures	48
3.1.2	Countermeasures against inverter-generated EMI	50
3.2	Power supply harmonics	53
3.2.1	Power supply harmonics	53
3.2.2	Harmonic suppression guidelines in Japan	53
3.3	Installation of a reactor	57
3.4	Power shutdown and magnetic contactor (MC)	58
3.5	Countermeasures against deterioration of the 400 V class motor insulation	59
3.6	Checklist before starting operation	60
3.7	Failsafe system which uses the inverter	62

Chapter 4 BASIC OPERATION 66

4.1	Operation panel	66
4.1.1	Components of the operation panel	66
4.1.2	Basic operation of the operation panel	67
4.1.3	Digital characters and their corresponding printed equivalents	68
4.1.4	Changing the parameter setting value	69
4.2	Monitoring the inverter	70
4.2.1	Monitoring of output current or output voltage	70

Chapter 5 PARAMETERS 72

5.1	Parameter list	72
5.1.1	Parameter list (by parameter number)	72
5.1.2	Use of a function group number for the identification of parameters	79
5.1.3	Parameter list (by function group number)	81
5.2	Control method	84
5.3	(E) Environment setting parameters	85
5.3.1	Reset selection / Disconnected PU detection / PU stop selection	85
5.3.2	PU display language selection	87
5.3.3	Beep control	87
5.3.4	PU contrast adjustment	88
5.3.5	RUN key rotation direction selection	88
5.3.6	Frequency easy setting function selection/ key lock function selection	88
5.3.7	Parameter write selection	89
5.3.8	Password	90
5.3.9	PWM carrier frequency and Soft-PWM control	92
5.4	(F) Setting of acceleration/deceleration time and acceleration/deceleration pattern	93
5.4.1	Setting the acceleration and deceleration time	93
5.4.2	Acceleration/deceleration pattern	95
5.4.3	Remote setting function	96

5.4.4	Starting frequency	99
5.5	(D) Operation command and frequency command	100
5.5.1	Operation mode selection	100
5.5.2	Startup of the inverter in the Network operation mode at power-ON	104
5.5.3	Command interface/source for start command and frequency command during communication operation	105
5.5.4	Reverse rotation prevention selection	108
5.5.5	JOG operation	108
5.5.6	Operation by multi-speed setting	109
5.6	(H) Protective function parameter	112
5.6.1	Motor overheat protection (electronic thermal O/L relay)	112
5.6.2	Earth (ground) fault detection at start	114
5.6.3	Inverter output fault detection enable/disable selection	114
5.6.4	Undervoltage detection enable/disable selection	115
5.6.5	I/O phase loss protection selection	115
5.6.6	Retry function	115
5.6.7	Limiting the output frequency (maximum/minimum frequency)	117
5.6.8	Avoiding machine resonance points (frequency jump)	118
5.6.9	Stall prevention operation	119
5.7	(M) Item and output signal for monitoring	124
5.7.1	Monitor item selection on operation panel or via communication	124
5.7.2	Output terminal function selection	126
5.7.3	Output frequency detection	129
5.7.4	Output current detection function	129
5.8	(T) Multi-function input terminal parameters	131
5.8.1	Analog input selection	131
5.8.2	Response level of analog input and noise elimination	134
5.8.3	Frequency setting voltage (current) bias and gain	134
5.8.4	Checking of current input on analog input terminal	139
5.8.5	Input terminal function selection	142
5.8.6	Inverter output shutoff	143
5.8.7	Start signal operation selection	145
5.9	(C) Motor constant parameters	147
5.9.1	Applied motor	147
5.9.2	Offline auto tuning	147
5.10	(A) Application parameters	151
5.10.1	Traverse function	151
5.10.2	PID control	152
5.10.3	Automatic restart after instantaneous power failure	159
5.10.4	Power failure time deceleration-to-stop function	160
5.11	(N) Communication operation parameters	163
5.11.1	Wiring and configuration of PU connector	163
5.11.2	Initial setting of operation via communication	165
5.11.3	Initial settings and specifications of RS-485 communication	168
5.11.4	Mitsubishi inverter protocol (computer link communication)	169
5.11.5	MODBUS RTU communication specification	182
5.12	(G) Control parameters	193
5.12.1	Manual torque boost	193
5.12.2	Base frequency voltage	194
5.12.3	Energy saving control	195
5.12.4	Adjustable 3 points V/F	195
5.12.5	DC injection brake	197
5.12.6	Stop selection	198

5.12.7	Regeneration avoidance function	199
5.12.8	Increased magnetic excitation deceleration	200
5.12.9	Slip compensation	202
5.13	Parameter clear / All parameter clear	203
5.14	Checking parameters changed from their initial values (initial value change list)	204

Chapter 6 PROTECTIVE FUNCTIONS..... 206

6.1	Inverter fault and indication	206
6.2	Reset method for the protective functions	207
6.3	Check and clear of the fault history	208
6.4	List of fault indications	210
6.5	Causes and corrective actions	211
6.6	Check first when you have a trouble	219
6.6.1	Motor does not start	219
6.6.2	Motor or machine is making abnormal acoustic noise	222
6.6.3	Motor generates heat abnormally	222
6.6.4	Motor rotates in the opposite direction	222
6.6.5	Speed greatly differs from the setting	223
6.6.6	Acceleration/deceleration is not smooth	223
6.6.7	Speed varies during operation	224
6.6.8	Operation mode is not changed properly	224
6.6.9	The motor current is too large	225
6.6.10	Speed does not accelerate	225
6.6.11	Unable to write parameter setting	226

Chapter 7 PRECAUTIONS FOR MAINTENANCE AND INSPECTION 228

7.1	Inspection item	228
7.1.1	Daily inspection	228
7.1.2	Periodic inspection	228
7.1.3	Daily and periodic inspection	228
7.1.4	Checking the inverter and converter modules	230
7.1.5	Cleaning	231
7.1.6	Lifespan	231
7.2	Measurement of main circuit voltages, currents, and powers	232
7.2.1	Measurement of powers	234
7.2.2	Measurement of voltages and use of PT	234
7.2.3	Measurement of currents	235
7.2.4	Use of CT and transducer	235
7.2.5	Measurement of inverter input power factor	235
7.2.6	Measurement of converter output voltage (between terminals P and N)	235
7.2.7	Insulation resistance test using megger	236
7.2.8	Pressure test	236

Chapter 8 SPECIFICATIONS 238

8.1 Inverter rating. 238

8.2 Common specifications 239

8.3 Outline dimension drawings. 241

8.3.1 Inverter outline dimension drawings 241

Safety instructions

Thank you for choosing Mitsubishi Electric inverter.

This Instruction Manual (Detailed) provides detailed instructions for advanced settings of the FREQROL-CS80 series inverters. Incorrect handling might cause an unexpected fault. Before using this product, carefully read this Instruction Manual (Detailed) and the printed instructions supplied with this product to ensure proper use of this product.

Do not attempt to install, operate, maintain or inspect this product until you have read the Instruction Manuals and appended documents carefully. Do not use this product until you have a full knowledge of this product mechanism, safety information and instructions.

Installation, operation, maintenance and inspection must be performed by qualified personnel. Here, qualified personnel means a person who meets all the following conditions:

- A person who possesses a certification in regard with electric appliance handling, or person took a proper engineering training. Such training may be available at your local Mitsubishi Electric office. Contact your local sales office for schedules and locations.
- A person who can access operating manuals for the protective devices (for example, light curtain) connected to the safety control system, or a person who has read these manuals thoroughly and familiarized himself/herself with the protective devices.

In this Instruction Manual, the safety instruction levels are classified into "WARNING" and "CAUTION".



Incorrect handling may cause hazardous conditions, resulting in death or severe injury.



Incorrect handling may cause hazardous conditions, resulting in medium or slight injury, or may cause only material damage.

Note that even the  **CAUTION** level may lead to a serious consequence depending on conditions. Be sure to follow the instructions of both levels as they are critical to personnel safety.

◆Electric shock prevention

WARNING

- Do not remove the front cover or the wiring cover while the inverter power is ON, and do not run the inverter with the front cover or the wiring cover removed as the exposed high voltage terminals or the charging part of the circuitry can be touched. Otherwise you may get an electric shock.
 - Even if power is OFF, do not remove the front cover except for wiring or periodic inspection as the inside of the inverter is charged. Otherwise you may get an electric shock.
 - Before wiring or inspection, check that the LED display of the operation panel is OFF. Any person who is involved in wiring or inspection shall wait for 10 minutes or longer after the power supply has been cut off, and check that there are no residual voltage using a tester or the like. The capacitor is charged with high voltage for some time after power OFF, and it is dangerous.
 - The inverter must be earthed (grounded). Earthing (grounding) must conform to the requirements of national and local safety regulations and electrical code (NEC section 250, IEC 61140 class 1 and other applicable standards). A neutral-point earthed (grounded) power supply must be used to be compliant with EN standard.
 - Any person who is involved in wiring or inspection of this product shall be fully competent to do the work.
 - The product body must be installed before wiring. Otherwise you may get an electric shock or be injured.
 - Key operations must be performed with dry hands to prevent an electric shock. Otherwise you may get an electric shock.
 - Do not subject the cables to scratches, excessive stress, heavy loads or pinching. Otherwise you may get an electric shock.
 - Do not touch the printed circuit board or handle the cables with wet hands. Otherwise you may get an electric shock.
-

◆Fire prevention

CAUTION

- The inverter must be installed on a nonflammable wall without any through holes so that nobody touches the heatsink, etc. on the rear side of the inverter. Installing it on or near flammable material may cause a fire.
 - If the inverter has become faulty, the inverter power must be switched OFF. A continuous flow of large current may cause a fire.
 - Do not connect a resistor directly to the DC terminals P/+ and N/-. Doing so could cause a fire.
 - Be sure to perform daily and periodic inspections as specified in the Instruction Manual. If this product is used without any inspection, a burst, breakage, or a fire may occur.
-

◆Injury prevention

CAUTION

- The voltage applied to each terminal must be as specified in the Instruction Manual. Otherwise burst, damage, etc. may occur.
 - The cables must be connected to the correct terminals. Otherwise burst, damage, etc. may occur.
 - The polarity (+ and -) must be correct. Otherwise burst, damage, etc. may occur.
 - While power is ON or for some time after power-OFF, do not touch the inverter as it will be extremely hot. Touching these devices may cause a burn.
-

◆ Additional instructions

The following instructions must be also followed. If the product is handled incorrectly, it may cause unexpected fault, an injury, or an electric shock.

CAUTION

Transportation and installing

- Any person who is opening a package using a sharp object, such as a knife or cutter, must wear gloves to prevent injuries caused by the edge of the sharp object.
- The product must be transported in correct method that corresponds to the weight. Failure to do so may lead to injuries.
- Do not stand or place any heavy object on the product.
- Do not stack the boxes containing products higher than the number recommended.
- When carrying the product, do not hold it by the front cover. Doing so may cause a fall or failure of the product.
- During installation, caution must be taken not to drop the inverter as doing so may cause injuries.
- The product must be installed on the surface that withstands the weight of the product.
- Do not install the product on a hot surface.
- The installing orientation of the inverter must be correct.
- The inverter must be installed on a strong surface securely with screws so that it does not drop.
- Do not install or operate the inverter if it is damaged or has parts missing.
- Foreign conductive objects must be prevented from entering the inverter. That includes screws and metal fragments or other flammable substance such as oil.
- As the inverter is a precision instrument, do not drop or subject it to impact.
- The surrounding air temperature must be between -10 and +40°C*1 (non-freezing). Otherwise the inverter may be damaged.
- The ambient humidity must be 95% RH or less (non-condensing) for the inverter. Otherwise the inverter may be damaged. (Refer to [page 23](#) for details.)
- The temporary storage temperature (applicable to a short limited time such as a transportation time) must be between -20 and +65°C. Otherwise the inverter may be damaged.
- The inverter must be used indoors (without corrosive gas, flammable gas, oil mist, dust and dirt). Otherwise the inverter may be damaged.
- The inverter must be used at an altitude of 2500 m or less, with 5.9 m/s² or less vibration at 10 to 55 Hz (directions of X, Y, Z axes). Otherwise the inverter may be damaged. (For the installation at an altitude above 1000 m, consider a 3% reduction in the rated current per 500 m increase in altitude. Refer to [page 23](#) for details.)
- If halogen-based materials (fluorine, chlorine, bromine, iodine, etc.), included in fumigants to sterilize or disinfect wooden packages, infiltrate into the product, the product may be damaged. Prevent residual fumigant components from being infiltrated into the product when packaging, or use an alternative sterilization or disinfection method (heat disinfection, etc.). Note that sterilization of disinfection of wooden package should be performed before packing the product.

Wiring

- Do not install a power factor correction capacitor, surge absorber, or radio noise filter on the inverter's output side. These devices on the inverter output side may be overheated or burn out.
- The output of the inverter (output terminals U, V, W) must be correctly connected to a motor. Otherwise the motor rotates inversely.

Test operation

- Before starting the test operation, confirm or adjust the parameter settings. A failure to do so may cause some machines to make unexpected motions.

*1 40 to 50°C (non-freezing) at the rated current reduced by 15%.

WARNING

Usage

- Any person must stay away from the motor or machinery when the retry function or the automatic restart after instantaneous power failure function is set in the inverter as the motor or the machine will restart suddenly after an inverter fault or instantaneous power failure.
 - It may happen depending on the inverter's function settings that the inverter does not stop its output even when the STOP/RESET key on the operation panel is pressed. To prepare for it, provide a separate circuit and switch (to turn the inverter power OFF, or apply a mechanical brake, etc.) for an emergency stop.
 - Be sure to turn OFF the start (STF/STR) signal before clearing the fault as the inverter will restart the motor suddenly after a fault clear.
 - Use only a three-phase induction motor as a load on this product. Connection of any other electrical equipment to the inverter output may damage the equipment.
 - Do not modify the product.
 - Do not remove any part which is not instructed to be removed in the Instruction Manuals. Doing so may lead to a failure or damage of the product.
-

CAUTION

Usage

- The electronic thermal O/L relay function may not be enough for protection of a motor from overheating. It is recommended to install an external thermal relay for overheat protection.
- Do not use a magnetic contactor on the inverter input side for frequent starting/stopping of the inverter. Otherwise the life of the inverter decreases.
- Use a noise filter or other means to minimize the electromagnetic interference with other electronic equipment used nearby the inverter.
- Appropriate measures must be taken to suppress harmonics. Otherwise harmonics in power systems generated from the inverter may heat/damage a power factor correction capacitor or a generator.
- For a 400 V class motor driven by the inverter, use an insulation-enhanced motor, or take measures to suppress surge voltage. Otherwise surge voltage attributable to the line constants may occur at the motor terminals, deteriorating the insulation of the motor.
- As all parameters return to their initial values after the Parameter clear or All parameter clear is performed, the needed parameters for the inverter operation must be set again before the operation is started.
- The inverter can be easily set for high-speed operation. Therefore, consider all things related to the operation such as the performance of a motor and equipment in a system before the setting change.
- Before running an inverter which have been stored and not been operated for a long period, perform an inspection and a test operation.
- To avoid damage to the product due to static electricity, static electricity in your body must be discharged before you touch the product.

Emergency stop

- A safety backup such as an emergency brake must be provided for devices or equipment in a system to prevent hazardous conditions in case of the inverter failure.
- If a breaker on the inverter input side is tripped, the wiring must be checked for a fault (such as short circuit), and internal parts of the inverter for a damage, etc. Identify and remove the cause of the trip before resetting the tripped breaker (or before applying the power to the inverter again).
- When any protective function is activated, take an appropriate corrective action before resetting the inverter to resume the operation.

Maintenance, inspection and parts replacement

- Do not carry out a megger (insulation resistance) test on the control circuit of the inverter. Doing so will cause a failure.

Disposal

- The product must be treated as industrial waste.
-

General instruction

- For clarity purpose, illustrations in this Instruction Manual may be drawn with covers or safety guards removed. Ensure all covers and safety guards are properly installed prior to starting operation.
-

CHAPTER 1 INTRODUCTION

1.1	Product checking and accessories	13
1.2	Component names	14
1.3	About the related manuals	14

1 INTRODUCTION

The contents described in this chapter must be read before using this product.

Always read the instructions before use.

◆ Abbreviations

Item	Description
Operation panel	Operation panel equipped on the inverter
Parameter unit	Parameter unit (FR-PU07)
PU	Operation panel on the inverter / enclosure surface operation panel (FR-PA07) / LCD operation panel (FR-LU08) / parameter unit
Inverter	Mitsubishi Electric FREQROL-CS80 series inverter
Pr.	Parameter number (Number assigned to function)
PU operation	Operation using the PU (operation panel/parameter unit)
External operation	Operation using the control circuit signals
Combined operation	Combined operation using the PU (operation panel/parameter unit) and External operation
Mitsubishi Electric standard motor	SF-JR
Mitsubishi Electric constant-torque motor	SF-HRCA

◆ Trademarks

- Microsoft and Visual C++ are registered trademarks of Microsoft Corporation in the United States and other countries.
- MODBUS is a registered trademark of SCHNEIDER ELECTRIC USA, INC.
- Other company and product names herein are the trademarks and registered trademarks of their respective owners.

◆ Notes on descriptions in this Instruction Manual

- Connection diagrams in this Instruction Manual appear with the control logic of the input terminals as source logic, unless otherwise specified. (For the control logic, refer to [page 36](#).)

◆ Harmonic Suppression Guidelines

- All the models of the inverters used by specific consumers are covered by "the Harmonic Suppression Guidelines for Consumers Who Receive High Voltage or Special High Voltage". (For details, refer to [page 53](#).)

1.1 Product checking and accessories

Unpack the product and check the rating plate and the capacity plate of the inverter to ensure that the model agrees with the order and the product is intact.

◆ Inverter model

FR-CS 8 4 -080 -60

Symbol	Voltage class	Symbol	Voltage	Symbol	Description	Symbol	Circuit board coating (conforming to IEC60721-3-3 3C2/3S2)
2	200 V class	None	Three-phase	012 to 295	Inverter SLD rated current (A)	-60	With
4	400 V class	S	Single-phase				

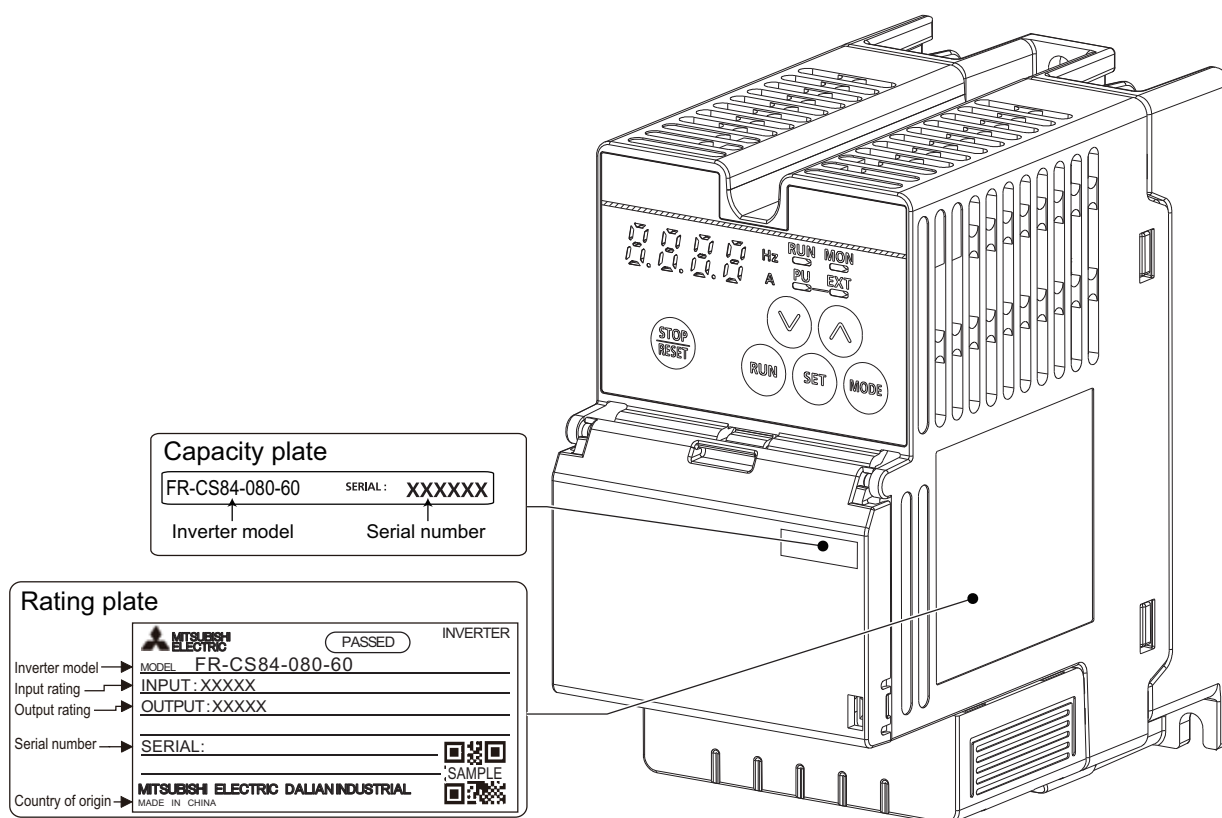

◆ How to read the SERIAL number

Rating plate example

 Symbol Year Month Control number
 SERIAL

The SERIAL consists of one symbol, two characters indicating the production year and month, and six characters indicating the control number.

The last digit of the production year is indicated as the Year, and the Month is indicated by 1 to 9, X (October), Y (November), or Z (December).

1.2 Component names

Component names are as follows.

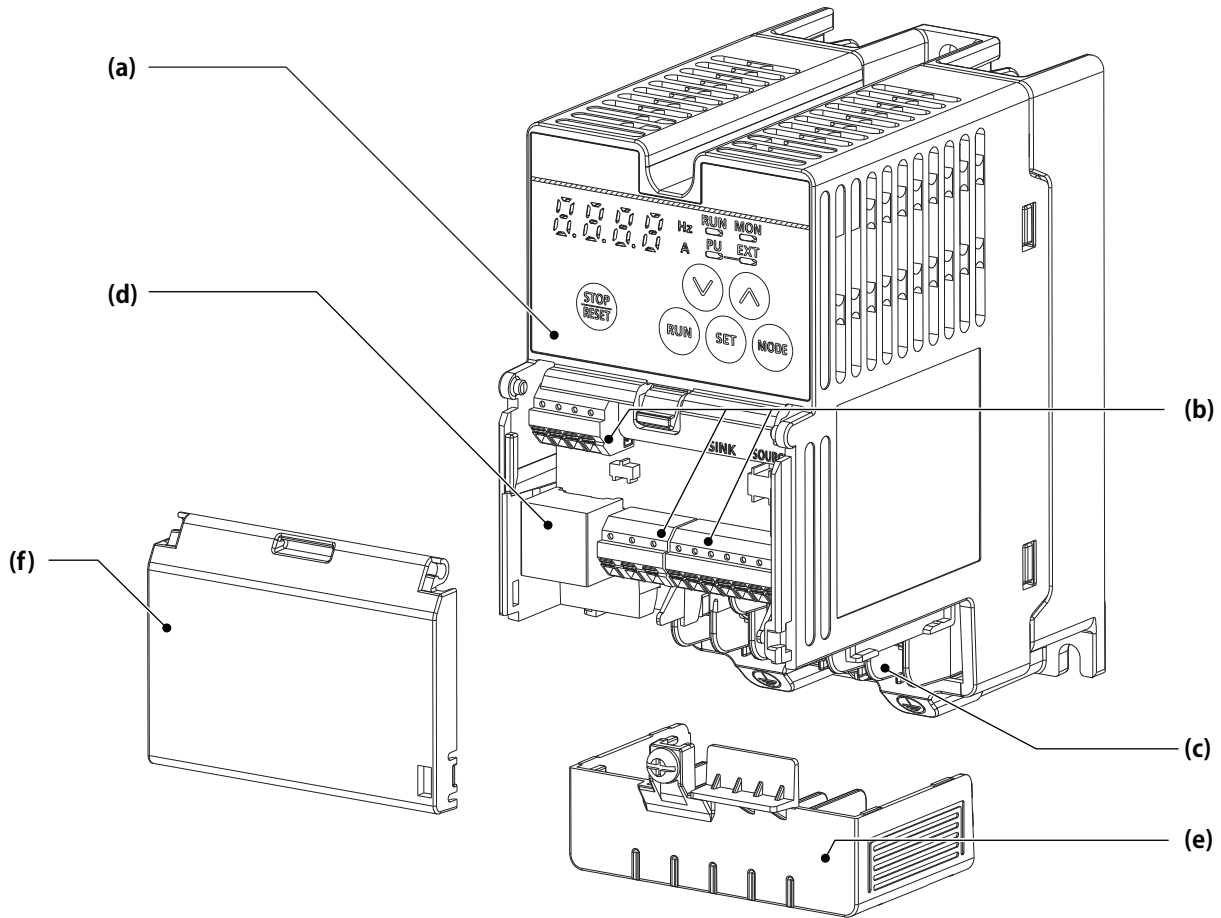

Symbol	Name	Description	Refer to page
(a)	Operation panel	Operates and monitors the inverter.	41
(b)	Control circuit terminal block	Connects cables for the control circuit.	35
(c)	Main circuit terminal block	Connects cables for the main circuit.	31
(d)	PU connector	Connects the operation panel or the parameter unit. This connector also enables the RS-485 communication.	41
(e)	Wiring cover	This cover is removable without unplugging cables.	20
(f)	Front cover	Open this cover for wiring. Do not remove this cover.	20

1.3 About the related manuals

The manual related to FR-CS80 is as follows.

Manual name	Manual number
FREQROL-CS80 Instructions and Cautions for Use of Inverters	IB-0600720

CHAPTER 2 INSTALLATION AND WIRING

2.1	Peripheral devices	16
2.2	Removal and reinstallation of the wiring cover	20
2.3	Installation of the inverter and enclosure design	23
2.4	Terminal connection diagrams.....	29
2.5	Main circuit terminals	31
2.6	Control circuit.....	35
2.7	Communication connectors and terminals.....	41
2.8	Connection of stand-alone option units	42

2 INSTALLATION AND WIRING

This chapter explains the installation and the wiring of this product.
Always read the instructions before use.

2.1 Peripheral devices

2.1.1 Inverter and peripheral devices

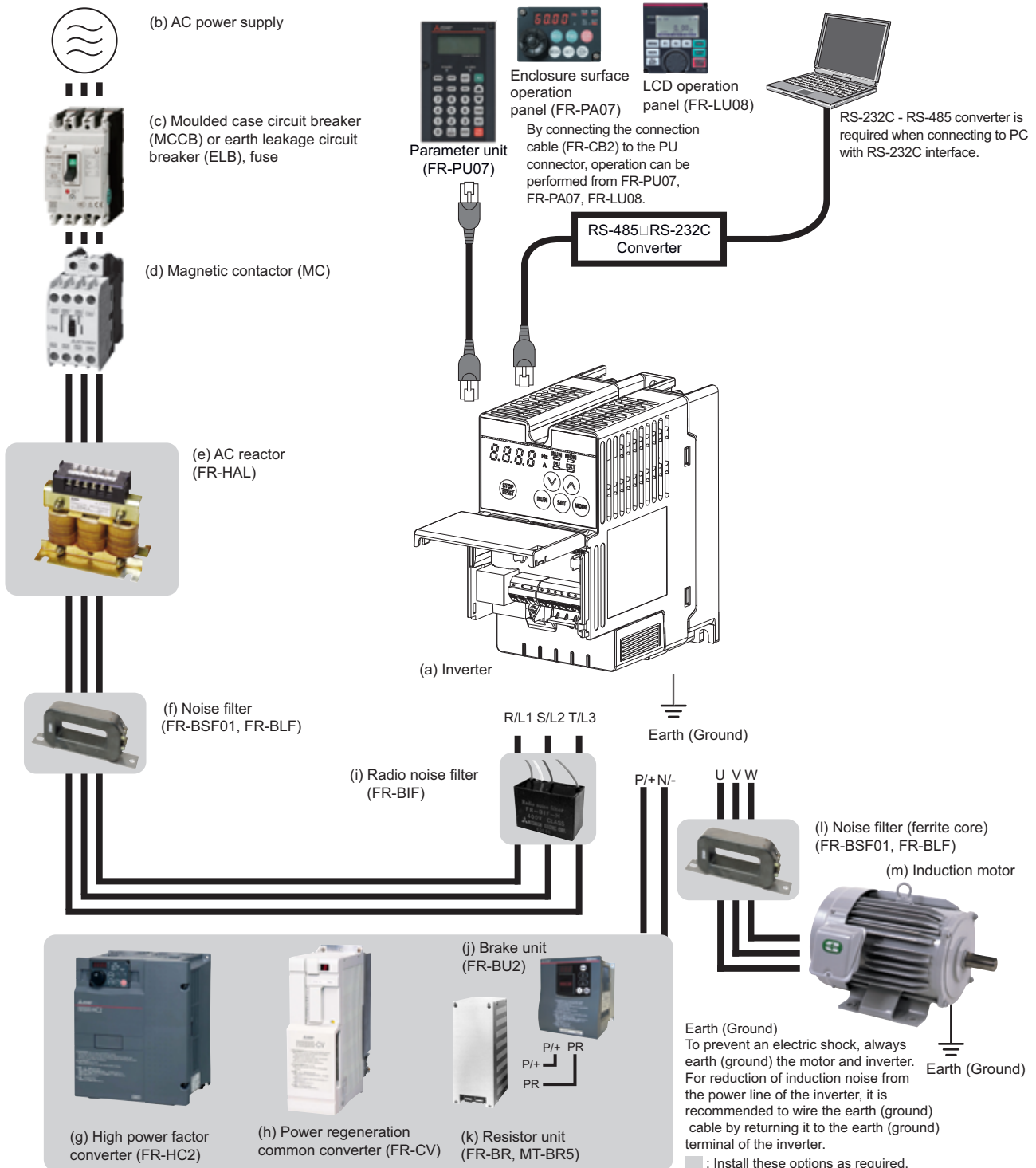

Symbol	Name	Overview	Refer to page
(a)	Inverter (FREQR0L-CS80)	The life of the inverter is influenced by the surrounding air temperature. The surrounding air temperature should be as low as possible within the permissible range. This must be noted especially when the inverter is installed in an enclosure. Incorrect wiring may lead to damage of the inverter. The control signal lines must be kept fully away from the main circuit lines to protect them from noise.	23, 29
(b)	AC power supply	Must be within the permissible power supply specifications of the inverter.	238
(c)	Molded case circuit breaker (MCCB), earth leakage circuit breaker (ELB), or fuse	Must be selected carefully since an inrush current flows in the inverter at power ON.	18
(d)	Magnetic contactor (MC)	Install this to ensure safety. Do not use this to start and stop the inverter. Doing so will shorten the life of the inverter.	58
(e)	AC reactor (FR-HAL)	Install this to suppress harmonics and to improve the power factor. An AC reactor (FR-HAL) (option) is required when installing the inverter near a large power supply system (500 kVA or more). Under such condition, the inverter may be damaged if you do not use a reactor. Select a reactor according to the applied motor capacity.	57
(f)	Noise filter (FR-BLF)	Install this to reduce the electromagnetic noise generated from the inverter. The noise filter is effective in the range from about 0.5 to 5 MHz. A wire should be wound four turns at maximum.	50
(g)	High power factor converter (FR-HC2)	Suppresses the power supply harmonics significantly. Install this as required.	44
(h)	Power regeneration common converter (FR-CV)	Provides a large braking capability. Install this as required.	45
(i)	Radio noise filter (FR-BIF)	Install this to reduce the radio noise.	—
(j)	Brake unit (FR-BU2)	Allows the inverter to provide the optimal regenerative braking capability.	42
(k)	Resistor unit (FR-BR)	Install this as required.	—
(l)	Noise filter (ferrite core) (FR-BSF01, FR-BLF)	Install this to reduce the electromagnetic noise generated from the inverter. The noise filter is effective in the range from about 0.5 to 5 MHz. A wire should be wound four turns at maximum.	—
(m)	Induction motor	Connect a squirrel-cage induction motor.	—

NOTE

- To prevent an electric shock, always earth (ground) the motor and inverter.
- Do not install a power factor correction capacitor or surge suppressor or capacitor type filter on the inverter's output side. Doing so will cause the inverter to be shut off or the capacitor and surge suppressor to be damaged. If any of the above devices is connected, immediately remove it. When installing a molded case circuit breaker on the output side of the inverter, contact the manufacturer of the molded case circuit breaker.
- Electromagnetic wave interference
The input/output (main circuit) of the inverter includes high frequency components, which may interfere with the communication devices (such as AM radios) used near the inverter. In such a case, install the optional radio noise filter FR-BIF (for use in the input side only) or line noise filter FR-BSF01 or FR-BLF to minimize interference. (Refer to [page 52](#)).
- For details of options and peripheral devices, refer to the respective Instruction Manual.

2.1.2 Peripheral devices

Check the model of the inverter you purchased. Appropriate peripheral devices must be selected according to the capacity. Refer to the following table to prepare appropriate peripheral devices.

◆ Molded case circuit breaker / earth leakage circuit breaker

- This is a matrix showing the rated current of the molded case circuit breaker (MCCB) or earth leakage circuit breaker (ELB) (NF or NV type) according to the selected inverter and rating.

Voltage	Inverter model	Without the power factor improving reactor	With the power factor improving reactor
Three-phase 400 V class	FR-CS84-012	5 A	5 A
	FR-CS84-022	5 A	5 A
	FR-CS84-036	10 A	10 A
	FR-CS84-050	15 A	10 A
	FR-CS84-080	20 A	15 A
	FR-CS84-120	30 A	20 A
	FR-CS84-160	30 A	30 A
	FR-CS84-230	50 A	40 A
Single-phase 200V class	FR-CS84-295	60 A	50 A
	FR-CS82S-025	10 A	5 A
	FR-CS82S-042	15 A	10 A
	FR-CS82S-070	30 A	15 A
	FR-CS82S-100	40 A	30 A

NOTE

- Select an MCCB according to the power supply capacity.
- Install one MCCB per inverter. For the use in the United States or Canada, provide the appropriate UL and cUL listed fuse that is suitable for branch circuit protection. (Refer to the FREQROL-CS80 Instructions and Cautions for Use of Inverters.)

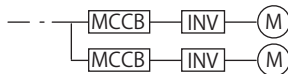

- When the inverter capacity is larger than the motor capacity, select an MCCB and a magnetic contactor according to the inverter model, and select cables and reactors according to the motor output.
- When the breaker on the inverter's input side trips, check for the wiring fault (short circuit), damage to internal parts of the inverter etc. The cause of the output shutoff must be identified and removed before turning ON the power of the breaker.

◆ Magnetic contactor at the inverter's input line

- This is a matrix showing the model name of the Mitsubishi magnetic contactor to be installed at the inverter's input line according to the selected inverter and rating.

Voltage	Inverter model	Without the power factor improving reactor	With the power factor improving reactor
Three-phase 400 V class	FR-CS84-012	S-T10	S-T10
	FR-CS84-022	S-T10	S-T10
	FR-CS84-036	S-T10	S-T10
	FR-CS84-050	S-T10	S-T10
	FR-CS84-080	S-T10	S-T10
	FR-CS84-120	S-T21	S-T12
	FR-CS84-160	S-T21	S-T21
	FR-CS84-230	S-T21	S-T21
Single-phase 200V class	FR-CS84-295	S-T35	S-T21
	FR-CS82S-025	S-T10	S-T10
	FR-CS82S-042	S-T10	S-T10
	FR-CS82S-070	S-T10	S-T10
	FR-CS82S-100	S-T10	S-T10

NOTE

- The matrix shows the magnetic contactor selected according to the standards of Japan Electrical Manufacturers' Association (JEM standards) for AC-1 class. The electrical durability of magnetic contactor is 500,000 times. When the magnetic contactor is used for emergency stops during motor driving, the electrical durability is 25 times. If using an MC for emergency stop during motor driving, select an MC for the inverter input current according to the rated current against JEM 1038 standards for AC-3 class. When installing an MC at the inverter output line to switch to the commercial-power supply operation while running a general-purpose motor, select an MC for the rated motor current according to the rated current against JEM 1038 standards for AC-3 class.
- When the inverter capacity is larger than the motor capacity, select an MCCB and a magnetic contactor according to the inverter model, and select cables and reactors according to the motor output.
- When the breaker on the inverter's input side trips, check for the wiring fault (short circuit), damage to internal parts of the inverter etc. The cause of the output shutoff must be identified and removed before turning ON the power of the breaker.

2.2 Removal and reinstallation of the wiring cover

◆ Removal for the FR-CS84-160 or lower and the FR-CS82S inverters

To remove the wiring cover, loosen the mounting screw of the cover, and pull out the cover. For the FR-CS84-012 to 080 or the FR-CS82S inverter, open the front cover to remove the wiring cover.

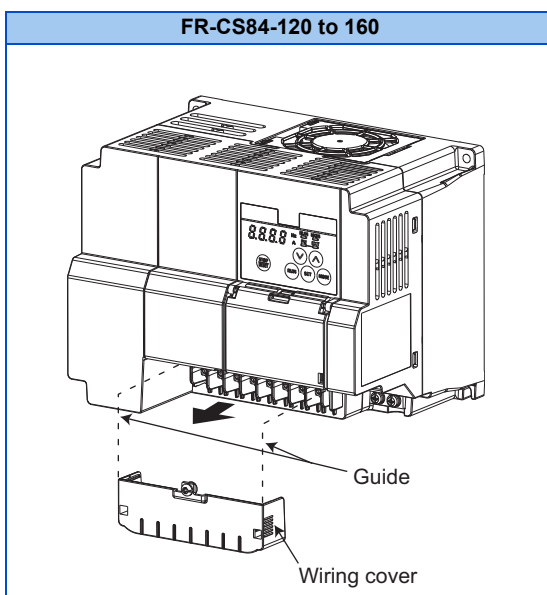
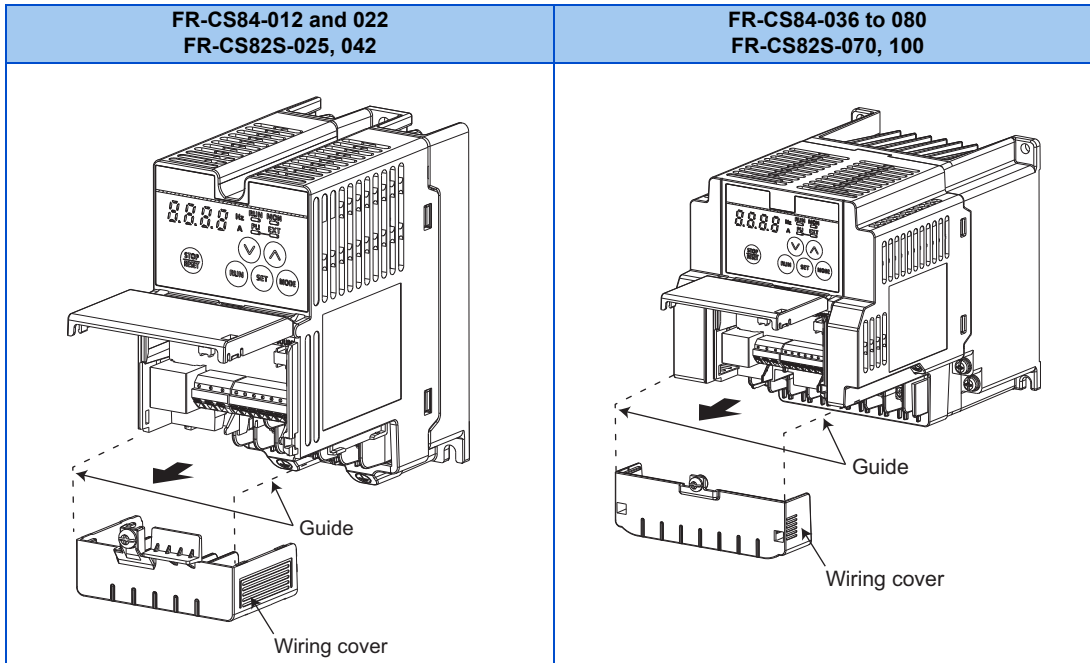

◆ Reinstallation for the FR-CS84-160 or lower and the FR-CS82S inverters

To reinstall the wiring cover, fit the cover to the inverter along the guides. Fasten the cover with the mounting screw.

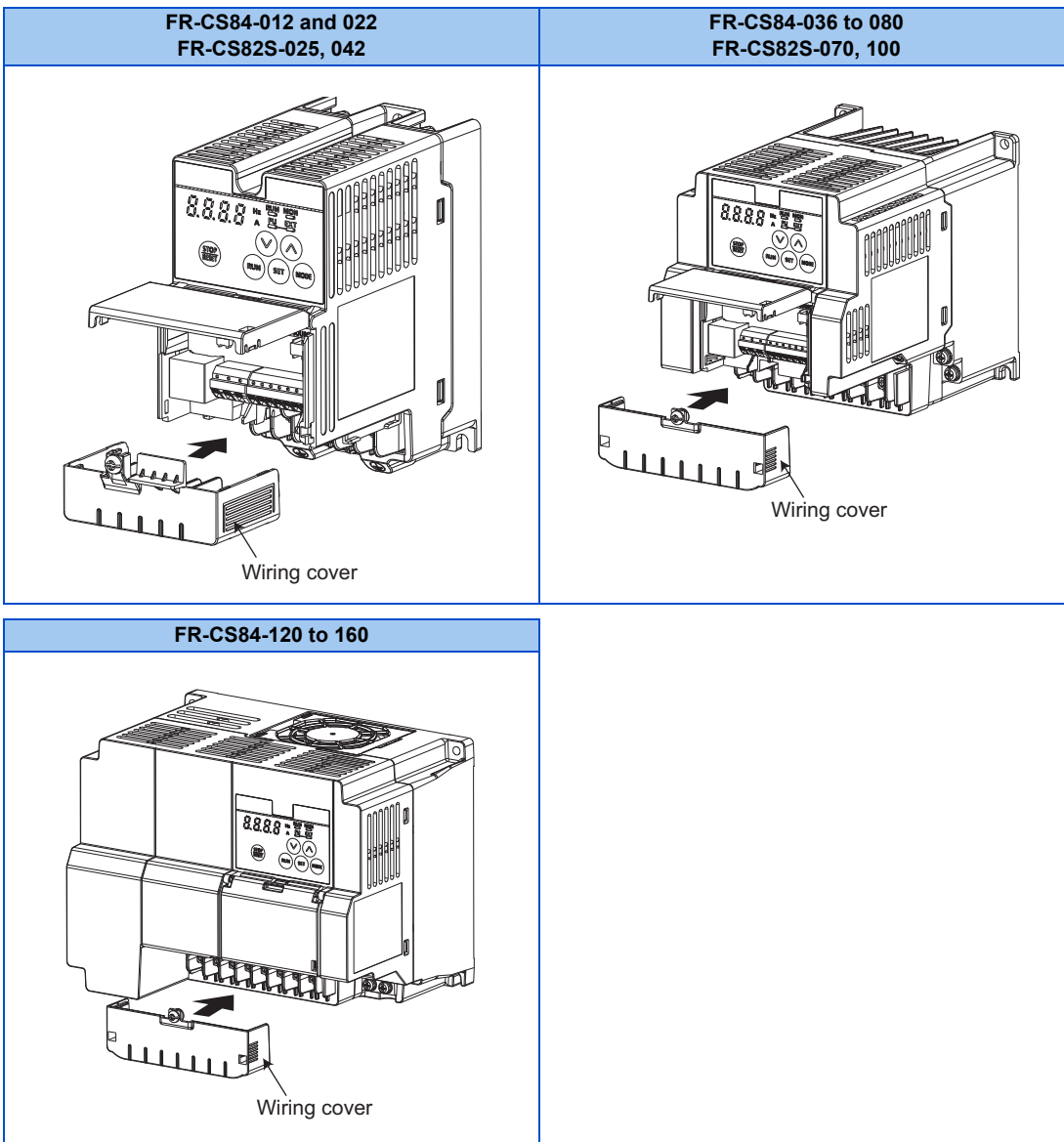

◆ Removal for the FR-CS84-230 or higher inverters

To remove the wiring cover, loosen the mounting screw of the cover. While holding the hooks of the inverter, pull out and remove the cover.

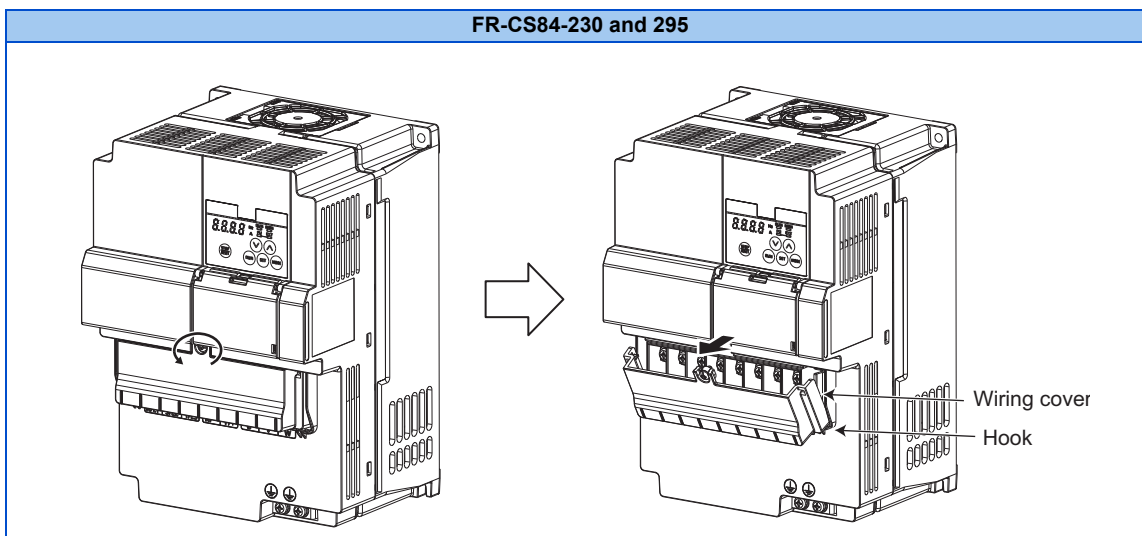

◆ Reinstallation for the FR-CS84-230 or lower and the FR-CS82S inverters

Fit the two sockets on the bottom of the cover to the hooks on the inverter, and install the cover to the inverter. Fasten the cover with the mounting screw.

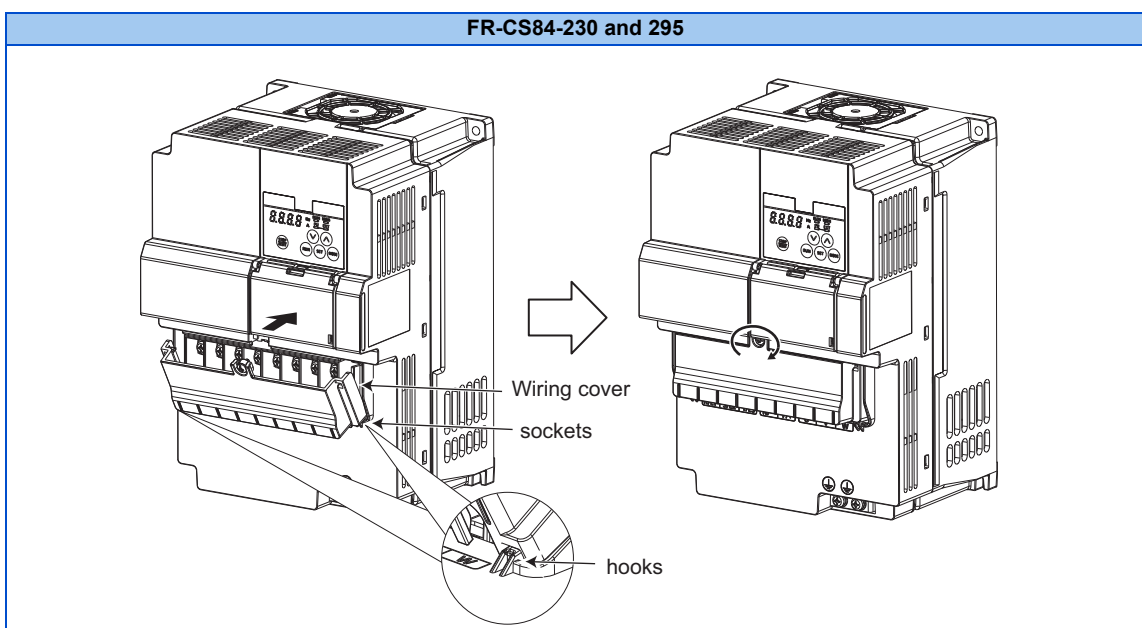

2.3 Installation of the inverter and enclosure design

When designing or manufacturing an inverter enclosure, determine the structure, size, and device layout of the enclosure by fully considering the conditions such as heat generation of the contained devices and the operating environment. An inverter unit uses many semiconductor devices. To ensure higher reliability and long period of operation, operate the inverter in the ambient environment that completely satisfies the equipment specifications.

2.3.1 Inverter installation environment

The following table lists the standard specifications of the inverter installation environment. Using the inverter in an environment that does not satisfy the conditions deteriorates the performance, shortens the life, and causes a failure. Refer to the following points, and take adequate measures.

◆ Standard environmental specifications of the inverter

Item	Description
Surrounding air temperature	-10 to +40°C (non-freezing) ^{*1}
Ambient humidity	With circuit board coating (conforming to class 3C2/3S2 in IEC 60721-3-3): 95% RH or less (non-condensing)
Storage temperature	-20 to +65°C ^{*2}
Atmosphere	Indoors (free from corrosive gas, flammable gas, oil mist, dust and dirt)
Altitude	2500 m or lower ^{*3}
Vibration	5.9 m/s ² or less at 10 to 55 Hz (directions of X, Y, Z axes)

*1 -40 to 50°C (non-freezing) at the rated current reduced by 15%.

*2 Temperature applicable for a short time, for example, in transit.

*3 For the installation at an altitude above 1000 m, consider a 3% reduction in the rated current per 500 m increase in altitude.

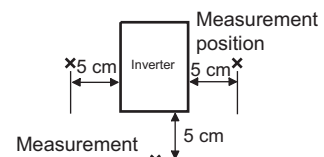

◆ Temperature

The permissible surrounding air temperature of the inverter is between -10 and +40°C. Always operate the inverter within this temperature range. Operation outside this range will considerably shorten the service lives of the semiconductors, parts, capacitors and others. Take the following measures to keep the surrounding air temperature of the inverter within the specified range.

■ Measures against high temperature

- Use a forced ventilation system or similar cooling system. (Refer to [page 26](#).)
- Install the enclosure in an air-conditioned electric chamber.
- Block direct sunlight.
- Provide a shield or similar plate to avoid direct exposure to the radiated heat and wind of a heat source.
- Ventilate the area around the enclosure well.

■ Measures against low temperature

- Provide a space heater in the enclosure.
- Do not power OFF the inverter. (Keep the start signal of the inverter OFF.)

■ Sudden temperature changes

- Select an installation place where temperature does not change suddenly.
- Avoid installing the inverter near the air outlet of an air conditioner.
- If temperature changes are caused by opening/closing of a door, install the inverter away from the door.

NOTE

- For the amount of heat generated by the inverter unit, refer to [page 25](#).

◆ Humidity

Operate the inverter within the ambient air humidity of usually up to 95% with circuit board coating. Too high humidity will pose problems of reduced insulation and metal corrosion. On the other hand, too low humidity may cause a spatial electrical breakdown. The humidity conditions for the insulation distance defined in JEM 1103 standard "Insulation Distance from Control Equipment" is 45 to 85%.

■ Measures against high humidity

- Make the enclosure enclosed, and provide it with a hygroscopic agent.
- Provide dry air into the enclosure from outside.
- Provide a space heater in the enclosure.

■ Measures against low humidity

Air with proper humidity can be blown into the enclosure from outside. Also, when installing or inspecting the unit, discharge your body (static electricity) beforehand, and keep your body away from the parts and patterns.

■ Measures against condensation

Condensation may occur if frequent operation stops change the in-enclosure temperature suddenly or if the outside air temperature changes suddenly.

Condensation causes such faults as reduced insulation and corrosion.

- Take the measures against high humidity.
- Do not power OFF the inverter. (Keep the start signal of the inverter OFF.)

◆ Dust, dirt, oil mist

Dust and dirt will cause such faults as poor contacts, reduced insulation and cooling effect due to the moisture-absorbed accumulated dust and dirt, and in-enclosure temperature rise due to a clogged filter. In an atmosphere where conductive powder floats, dust and dirt will cause such faults as malfunction, deteriorated insulation and short circuit in a short time.

Since oil mist will cause similar conditions, it is necessary to take adequate measures.

■ Countermeasure

- Place the inverter in a totally enclosed enclosure.
Take measures if the in-enclosure temperature rises. (Refer to [page 26](#).)
- Purge air.
Pump clean air from outside to make the in-enclosure air pressure higher than the outside air pressure.

◆ Corrosive gas, salt damage

If the inverter is exposed to corrosive gas or to salt near a beach, the printed board patterns and parts will corrode or the relays and switches will result in poor contact.

In such places, take the measures given in the previous paragraph.

◆ Explosive, flammable gases

As the inverter is non-explosion proof, it must be contained in an explosion-proof enclosure. In places where explosion may be caused by explosive gas, dust or dirt, an enclosure cannot be used unless it structurally complies with the guidelines and has passed the specified tests. This makes the enclosure itself expensive (including the test charges). The best way is to avoid installation in such places and install the inverter in a non-hazardous place.

◆ High altitude

Use the inverter at an altitude of within 2500 m. For use at an altitude above 1000 m, consider a 3% reduction in the rated current per 500 m increase in altitude.

If it is used at a higher place, it is likely that thin air will reduce the cooling effect and low air pressure will deteriorate dielectric strength.

◆ Vibration, impact

The vibration resistance of the inverter is up to 5.9 m/s² at 10 to 55 Hz frequency and 1 mm amplitude for the directions of X, Y, Z axes. Applying vibration and impacts for a long time may loosen the structures and cause poor contacts of connectors, even if those vibration and impacts are within the specified values.

Especially when impacts are applied repeatedly, caution must be taken because such impacts may break the installation feet.

■ Countermeasure

- Provide the enclosure with rubber vibration isolators.
- Strengthen the structure to prevent the enclosure from resonance.
- Install the enclosure away from the sources of the vibration.

2.3.2 Amount of heat generated by the inverter

◆ Installing the heatsink inside the enclosure

When the heatsink is installed inside the enclosure, the amount of heat generated by the inverter unit is shown in the following tables.

Voltage	Inverter model	Amount of heat generated (W)
Three-phase 400 V class	FR-CS84-012	15
	FR-CS84-022	25
	FR-CS84-036	50
	FR-CS84-050	75
	FR-CS84-080	120
	FR-CS84-120	140
	FR-CS84-160	190
	FR-CS84-230	425
	FR-CS84-295	480
Single-phase 200V class	FR-CS82S-025	25
	FR-CS82S-042	40
	FR-CS82S-070	70
	FR-CS82S-100	95

NOTE

- The amount of heat generated shown assumes that the output current is inverter rated current, power supply voltage is 440 V (400 V class), and carrier frequency is 2 kHz.

2.3.3 Cooling system types for inverter enclosure

From the enclosure that contains the inverter, the heat of the inverter and other equipment (transformers, lamps, resistors, etc.) and the incoming heat such as direct sunlight must be dissipated to keep the in-enclosure temperature lower than the permissible temperatures of the in-enclosure equipment including the inverter.

The cooling systems are classified as follows in terms of the cooling calculation method.

- Cooling by natural heat dissipation from the enclosure surface (totally enclosed type)
- Cooling by heat sink (aluminum fin, etc.)
- Cooling by ventilation (forced ventilation type, pipe ventilation type)
- Cooling by heat exchanger or cooler (heat pipe, cooler, etc.)

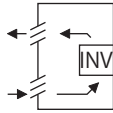
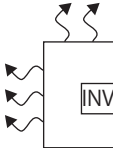
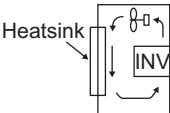
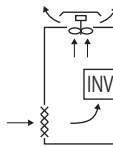
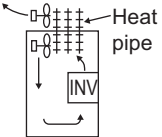
Cooling system		Enclosure structure	Comment
Natural	Natural ventilation (enclosed ventilated type)		This system is low in cost and generally used, but the enclosure size increases as the inverter capacity increases. This system is for relatively small capacities.
	Natural ventilation (totally enclosed type)		Being a totally enclosed type, this system is the most appropriate for hostile environment having dust, dirt, oil mist, etc. The enclosure size increases depending on the inverter capacity.
Forced air	Heat sink cooling		This system has restrictions on the heat sink mounting position and area. This system is for relatively small capacities.
	Forced ventilation		This system is for general indoor installation. This is appropriate for enclosure downsizing and cost reduction, and often used.
	Heat pipe		This is a totally enclosed for enclosure downsizing.

2.3.4 Inverter installation

◆ Inverter placement

- FR-CS84-012, 022
- FR-CS82S-025, 042

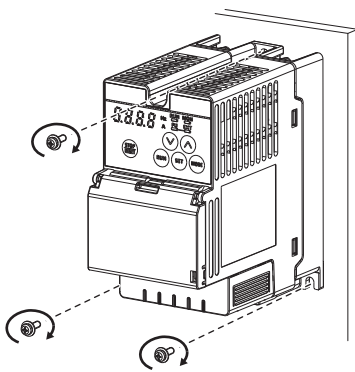

- FR-CS84-036 to 080
- FR-CS82S-070, 100

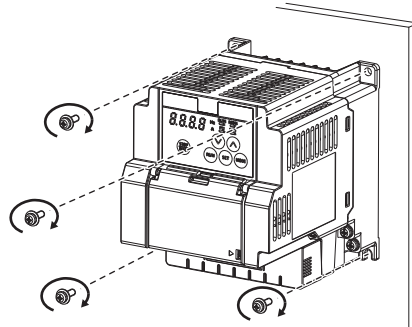

- FR-CS84-120, 160

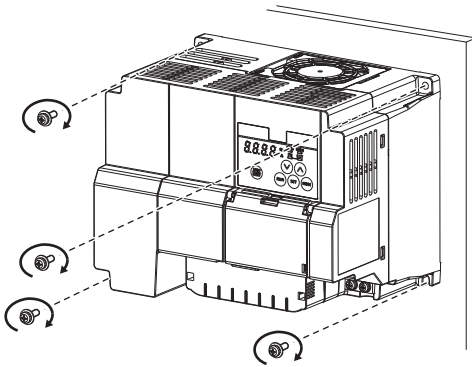

- FR-CS84-230, 295

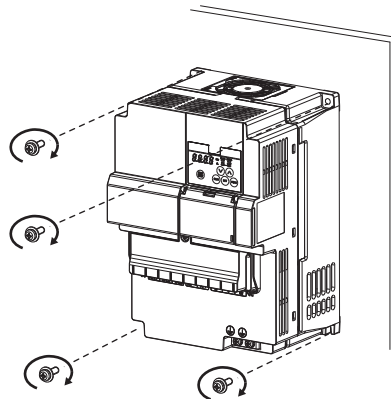

- Install the inverter on a strong surface securely with screws.
- Leave enough clearances and take cooling measures.
- Avoid places where the inverter is subjected to direct sunlight, high temperature and high humidity.
- Install the inverter on a nonflammable wall surface.
- When encasing multiple inverters in an enclosure, install them in parallel as a cooling measure.
- For heat dissipation and maintenance, keep clearance between the inverter and the other devices or enclosure surface. The clearance below the inverter is required as a wiring space, and the clearance above the inverter is required as a heat dissipation space.
- Install the inverter on the wall with no holes to prevent the cooling air from escaping.

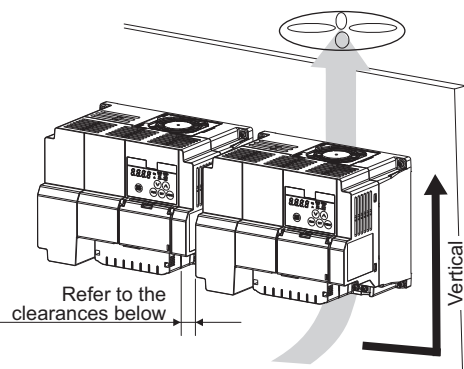

Clearances (front)

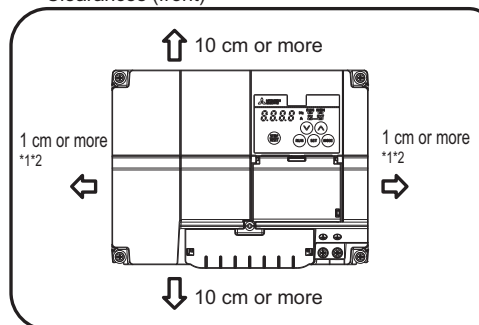

Clearances (side)

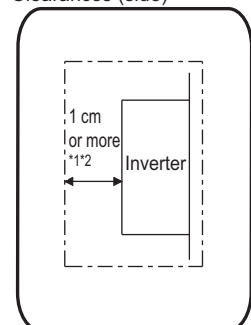

*1 FR-CS84-120 or lower, allow 5 cm or more clearance.

*2 When using the inverters at the surrounding air temperature of 40°C or less, the inverters can be installed closely attached (0 cm clearance).

◆ Installation orientation of the inverter

Install the inverter on a wall as specified. Do not mount it horizontally or in any other way.

◆ Above the inverter

Heat is blown up from inside the inverter by the small fan built in the unit. Any equipment placed above the inverter should be heat resistant.

◆ Arrangement of multiple inverters

When multiple inverters are placed in the same enclosure, generally arrange them horizontally as shown in the figure (a). When it is inevitable to arrange them vertically to minimize space, take such measures as to provide guides since heat from the bottom inverters can increase the temperatures in the top inverters, causing inverter failures.

When mounting multiple inverters, fully take caution not to make the surrounding air temperature of the inverter higher than the permissible value by providing ventilation and increasing the enclosure size.

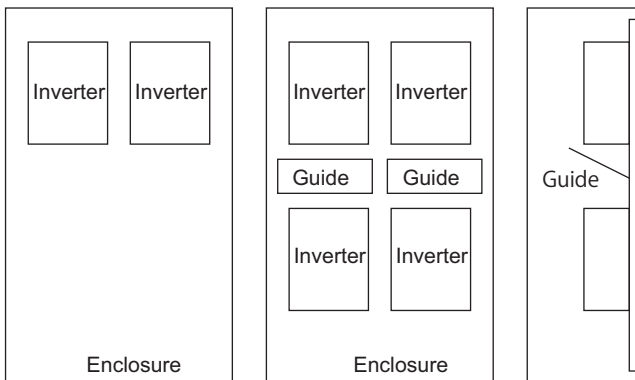

(a) Horizontal arrangement (b) Vertical arrangement
Arrangement of multiple inverters

◆ Arrangement of the ventilation fan and inverter

Heat generated in the inverter is blown up from the bottom of the unit as warm air by the cooling fan. When installing a ventilation fan for that heat, determine the place of ventilation fan installation after fully considering an air flow. (Air passes through areas of low resistance. Make an airway and airflow plates to expose the inverter to cool air.)

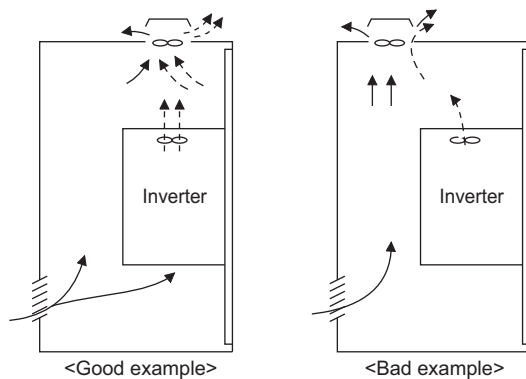

<Good example> <Bad example>
Arrangement of the ventilation fan and inverter

2.4 Terminal connection diagrams

- Source logic
- ⊙ Main circuit terminal
- Control circuit terminal

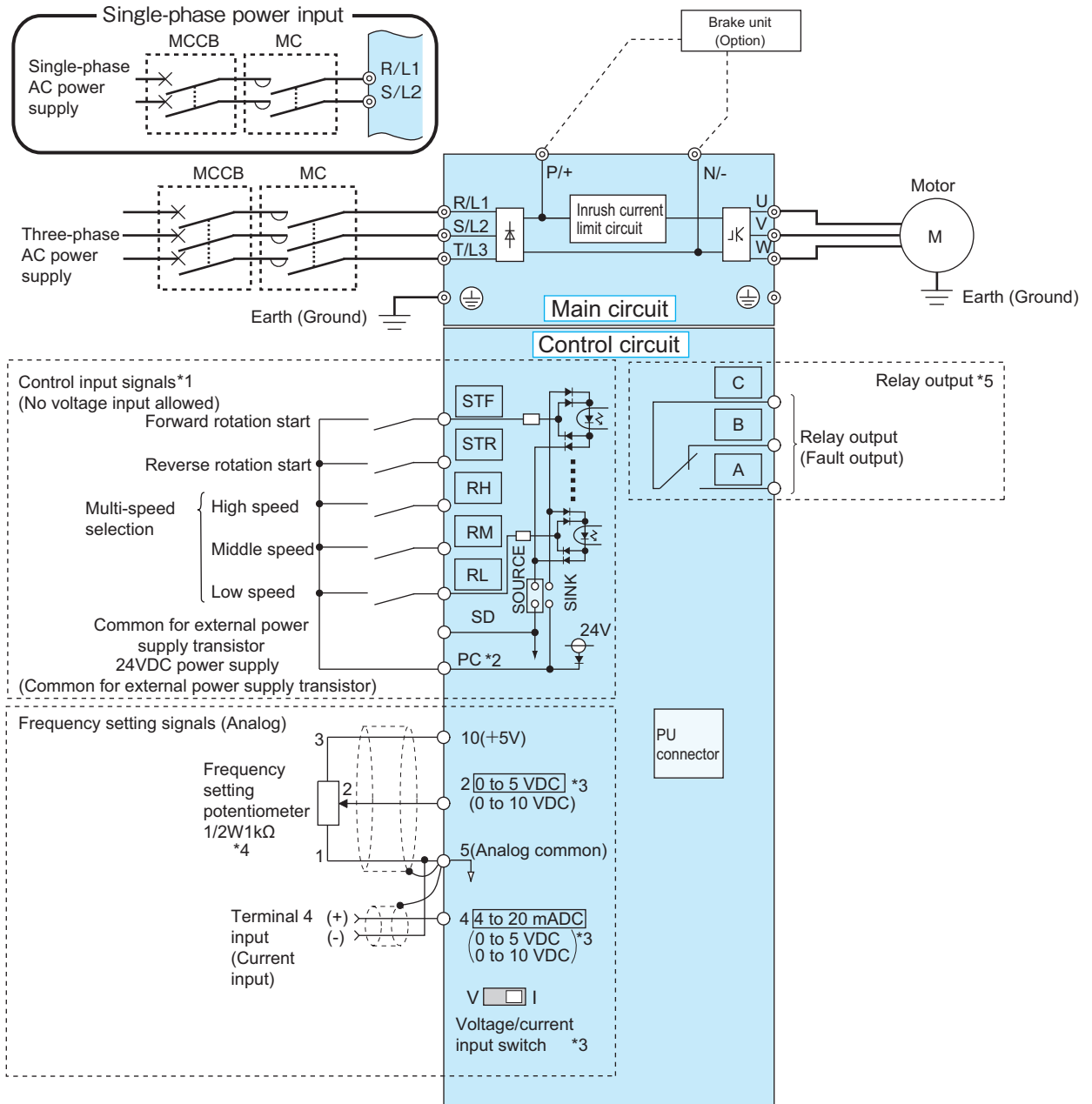

- *1 The signal assigned to each of these terminals can be changed to the reset signal, etc. using the input terminal assignment function (**Pr.178 to Pr.182**). (Refer to [page 142](#)).
- *2 To use terminals PC and SD for a 24 VDC power supply, check the wiring for an incorrect short of these terminals.
- *3 Terminal input specifications can be changed by analog input specification switchover (**Pr.73, Pr.267**). To input voltage via terminal 4, set the voltage/current input switch to "V" position. To input current (4 to 20 mA), set it to "I" position (initial setting).
- *4 It is recommended to use a 2 W 1 k Ω potentiometer when the frequency setting is frequently changed.
- *5 The function of these terminals can be changed with the output terminal assignment (**Pr.195**). (Refer to [page 126](#)).

NOTE

- To prevent a malfunction due to noise, keep the signal cables 10 cm or more away from the power cables. Also, keep the cables of the main circuit for input and output separated.
- After wiring, wire offcuts must not be left in the inverter.
Wire offcuts can cause an alarm, failure or malfunction. Always keep the inverter clean.
When drilling mounting holes in an enclosure etc., take caution not to allow chips and other foreign matter to enter the inverter.
- Set the voltage/current input switch correctly. Incorrect setting may cause a fault, failure or malfunction.
- The output of the single-phase power input model is three-phase 200V.

2.5 Main circuit terminals

2.5.1 Details on the main circuit terminals

Terminal symbol	Terminal name	Terminal function description	Refer to page
R/L1, S/L2, T/L3	AC power input	Connect these terminals to the commercial power supply. Do not connect anything to these terminals when using the high power factor converter (FR-HC2) or the power regeneration common converter (FR-CV).	—
U, V, W	Inverter output	Connect a three-phase squirrel-cage motor to these terminals.	—
P/+, N/-	Brake unit connection	Connect the brake unit (FR-BU2), power regeneration common converter (FR-CV), or high power factor converter (FR-HC2) to these terminals.	42
	Earth (ground)	For earthing (grounding) the inverter chassis. Be sure to earth (ground) the inverter.	33

2.5.2 Terminal layout of the main circuit terminals, wiring of power supply and the motor

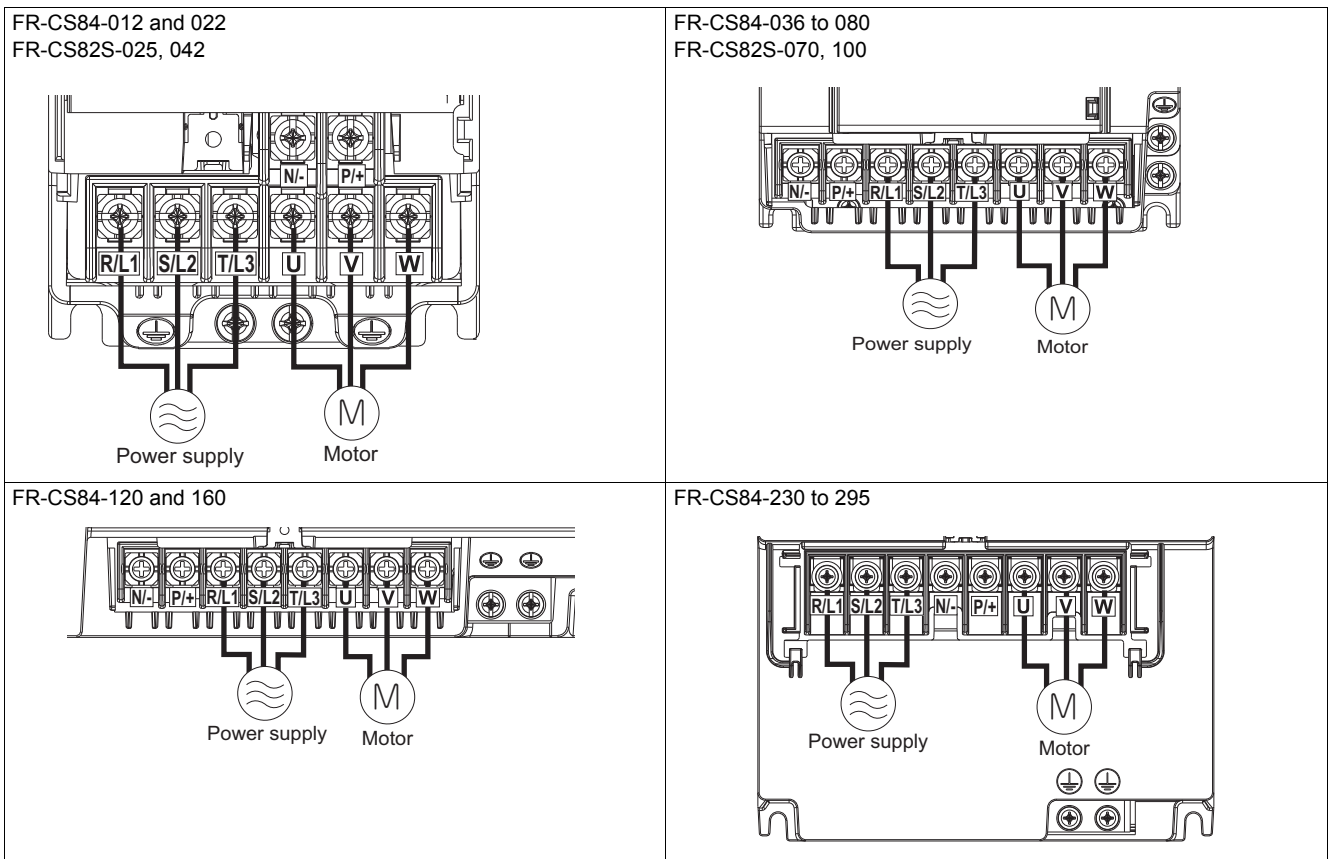

NOTE

- Make sure the power cables are connected to the R/L1, S/L2, and T/L3. However, the FR-CS82S is not equipped with terminal T/L3. (Phase need not be matched.) Never connect the power cable to the U, V, and W of the inverter. Doing so will damage the inverter.
- Connect the motor to U, V, and W. (The phases must be matched.)

2.5.3 Applicable cables and wiring length

Select a recommended cable size to ensure that the voltage drop will be 2% or less.

If the wiring distance is long between the inverter and motor, the voltage drop in the main circuit will cause the motor torque to decrease especially at a low speed.

The following table shows a selection example for the wiring length of 20 m.

- Three-phase 400 V class

Applicable inverter model FR-CS84-[]	Terminal screw size ⁵	Tightening torque N·m	Crimp terminal		Cable gauge							
					HIV cables, etc. (mm ²) ^{*1}			AWG/MCM ^{*2}		PVC cables, etc. (mm ²) ^{*4}		
			R/L1, S/L2, T/L3 ³	U, V, W	R/L1, S/L2, T/L3 ³	U, V, W	Earthing (grounding) cable	R/L1, S/L2, T/L3 ³	U, V, W	R/L1, S/L2, T/L3 ³	U, V, W	Earthing (grounding) cable
012, 022	M4	1.2	2-3.5	2-3.5	2	2	2	14	14	2.5	2.5	2.5
036 to 080	M4	1.5	2-4	2-4	2	2	2	14	14	2.5	2.5	2.5
120	M4	1.5	5.5-4	2-4	3.5	2	3.5	12	14	4	2.5	4
160	M4	1.5	5.5-4	5.5-4	3.5	3.5	3.5	12	12	4	4	4
230	M4	2.5	8-5	8-5	8	8	5.5	8	8	10	6	10
295	M4	2.5	8-5	8-5	8	8	5.5	8	8	10	10	10

- Single-phase 200V class

Applicable inverter model FR-CS82S-[]	Terminal screw size ⁵	Tightening torque N·m	Crimp terminal		Cable gauge							
					HIV cables, etc. (mm ²) ^{*1}			AWG/MCM ^{*2}		PVC cables, etc. (mm ²) ^{*4}		
			R/L1, S/L2, T/L3 ³	U, V, W	R/L1, S/L2, T/L3 ³	U, V, W	Earthing (grounding) cable	R/L1, S/L2, T/L3 ³	U, V, W	R/L1, S/L2, T/L3 ³	U, V, W	Earthing (grounding) cable
025, 042	M3.5	1.2	2-3.5	2-3.5	2	2	2	14	14	2.5	2.5	2.5
070	M4	1.5	2-4	2-4	2	2	2	14	14	2.5	2.5	2.5
100	M4	1.5	5.5-4	2-4	3.5	2	3.5	12	14	4	2.5	4

*1 It is the gauge of a cable with the continuous maximum permissible temperature of 75°C (HIV cable (600 V grade heat-resistant PVC insulated wire), etc.). It assumes a surrounding air temperature of 50°C or lower and the wiring distance of 20 m or shorter.

*2 It is the gauge of the cable with continuous maximum permissible temperature of 75°C (THHW cable). It assumes a surrounding air temperature of 40°C or lower and the wiring distance of 20 m or shorter.
(Selection example mainly for use in the United States.)

*3 When using a single-phase power input model, terminals are R/L1 and S/L2.

*4 It is the gauge of a cable with the continuous maximum permissible temperature of 70°C (PVC cable). It assumes a surrounding air temperature of 40°C or lower and the wiring distance of 20 m or shorter.
(Selection example mainly for use in Europe.)

*5 It indicates the size of screw for terminals R/L1, S/L2, T/L3, U, V, W, P/+ and N/- and a terminal for earthing (grounding).

The line voltage drop can be calculated by the following formula:

$$\text{Line voltage drop [V]} = \frac{\sqrt{3} \times \text{wire resistance [m}\Omega\text{/m]} \times \text{wiring distance [m]} \times \text{current [A]}}{1000}$$

Use a larger diameter cable when the wiring distance is long or when it is desired to decrease the voltage drop (torque reduction) in the low speed range.

NOTE

- Tighten the terminal screw to the specified torque.
A screw that has been tightened too loosely can cause a short circuit or malfunction.
A screw that has been tightened too tightly can cause a short circuit or malfunction due to the unit breakage.
- Use crimp terminals with insulation sleeves to wire the power supply and motor.

◆ Total wiring length

■ With induction motor

Connect one or more general-purpose motors within the total wiring length shown in the following table.

Cable type	Model FR-CS84-[]									Model FR-CS82S-[]			
	012	022	036	050	080	120	160	230	295	025	042	070	100
Unshielded	50 m	50 m	50 m	50 m	50 m	100 m	100 m	100 m	100 m	50 m	50 m	50 m	50 m
Shielded	25 m	25 m	50 m	50 m	50 m	100 m	100 m	100 m	100 m	25 m	25 m	50 m	50 m

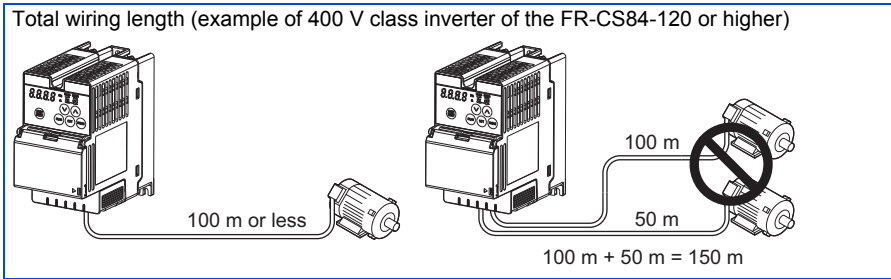

When driving a 400 V class motor by the inverter, surge voltages attributable to the wiring constants may occur at the motor terminals, deteriorating the insulation of the motor. In this case, take one of the following measure.

- Use a "400 V class inverter-driven insulation-enhanced motor" and set **Pr.72 PWM frequency selection** according to the wiring length.

Wiring length 50 m or shorter	Wiring length 50 to 100 m
Any setting	8 (8 kHz) or lower

NOTE

- Especially for long-distance wiring, the inverter may be affected by a charging current caused by stray capacitances of the wiring, leading to an activation of the overcurrent protection, malfunction of the fast-response current limit operation, or even to an inverter failure. It may also cause a malfunction or fault of the equipment connected ON the inverter output side. If the fast-response current limit function malfunctions, disable this function. (Refer to **Pr.156 Stall prevention operation selection** on [page 119](#).)
- For the details of **PWM frequency selection**, refer to [page 92](#).
- Refer to [page 59](#) to drive a 400 V class motor by the inverter.

2.5.4 Earthing (grounding) precautions

Always earth (ground) the motor and inverter.

◆ Purpose of earthing (grounding)

Generally, an electrical apparatus has an earth (ground) terminal, which must be connected to the ground before use.

An electrical circuit is usually insulated by an insulating material and encased. However, it is impossible to manufacture an insulating material that can shut off a leakage current completely, and actually, a slight current flows into the case. The purpose of earthing (grounding) the case of an electrical apparatus is to prevent operators from getting an electric shock from this leakage current when touching it.

To avoid the influence of external noises, this earthing (grounding) is important to audio equipment, sensors, computers and other apparatuses that handle low-level signals or operate very fast.

◆ Earthing (grounding) methods and earthing (grounding) work

As described previously, earthing (grounding) is roughly classified into an electrical shock prevention type and a noise-influenced malfunction prevention type. Therefore, these two types should be clearly distinguished, and the following work must be done to prevent the leakage current having the inverter's high frequency components from entering the malfunction prevention type earthing (grounding):

- Whenever possible, use the independent earthing (grounding) for the inverter.

If independent earthing (grounding) (I) is not available, use (II) common earthing (grounding) in the following figure where the inverter is connected with the other equipment at an earthing (grounding) point. Do not use the other equipment's earthing (grounding) cable to earth (ground) the inverter as shown in (III).

A leakage current containing many high frequency components flows into the earthing (grounding) cables of the inverter and peripheral devices. Because of this, the inverter must be earthed (grounded) separately from EMI-sensitive devices. In a high building, it may be effective to use the EMI prevention type earthing (grounding) connecting to an iron structure frame, and electric shock prevention type earthing (grounding) with the independent earthing (grounding) together.

- Earthing (grounding) must conform to the requirements of national and local safety regulations and electrical codes. (NEC section 250, IEC 536 class 1 and other applicable standards). A neutral-point earthed (grounded) power supply must be used to be compliant with EN standard.
- Use the thickest possible earthing (grounding) cable. The earthing (grounding) cable should be equal to or longer than the size indicated in the table on [page 32](#).
- The earthing (grounding) point should be as close as possible to the inverter, and the earth (ground) wire length should be as short as possible.
- Run the earthing (grounding) cable as far away as possible from the I/O wiring of equipment sensitive to noises and run them in parallel in the minimum distance.

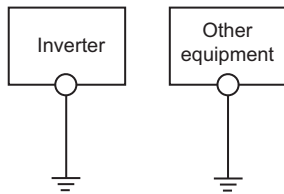

(I) Independent earthing (grounding): I

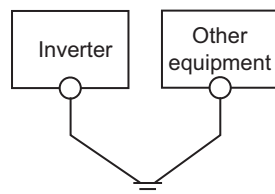

(II) Common earthing (grounding): Good

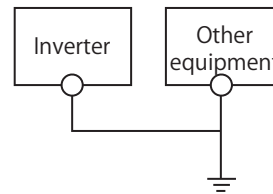

(III) Common earthing (grounding) cable: Not allowed

NOTE

- To be compliant with the EU Directive (Low Voltage Directive), refer to the **FREQROL-CS80 Instructions and Cautions for Use of Inverters**.

2.6 Control circuit

2.6.1 Details on the control circuit terminals

◆ Input signal

Type	Terminal symbol	Terminal name	Terminal function description		Rated specification	Refer to page
Contact input	STF	Forward rotation start	Turn ON the STF signal to start forward rotation and turn it OFF to stop.	When the STF and STR signals are turned ON simultaneously, the stop command is given.	Input resistance: 4.7 kΩ, voltage when contacts are open: 21 to 26 VDC, current when contacts are short-circuited: 4 to 6 mADC	145
	STR	Reverse rotation start	Turn ON the STR signal to start reverse rotation and turn it OFF to stop.			
	RH RM RL	Multi-speed selection	Multi-speed can be selected according to the combination of RH, RM and RL signals.			
	SD	Contact input common (sink)	Common terminal for the contact input terminal (sink logic).		—	—
		External transistor common (source)	Connect this terminal to the power supply common terminal of a transistor output (open collector output) device, such as a programmable controller, in the source logic to avoid malfunction by undesirable current.			
		24 VDC power supply common	Common terminal for the 24 VDC power supply (terminal PC). Isolated from terminal 5.			
	PC	External transistor common (sink)	Connect this terminal to the power supply common terminal of a transistor output (open collector output) device, such as a programmable controller, in the sink logic to avoid malfunction by undesirable current.		Power supply voltage range: 22 to 26.5 VDC, permissible load current: 30 mA	37
		Contact input common (source)	Common terminal for contact input terminal (source logic).			
		24 VDC power supply	Can be used as a 24 VDC 30 mA power supply.			
	Frequency setting	10	Frequency setting power supply	Used as the power supply for an external device such as a frequency setting potentiometer or digital panel meter.		5 VDC (±0.2 VDC), permissible load current: 10 mA
2		Frequency setting (voltage)	Inputting 0 to 5 VDC (or 0 to 10 VDC) provides the maximum output frequency at 5 V (or 10 V) and makes input and output proportional. Use Pr.73 to switch between input 0 to 5 VDC (initial setting) and 0 to 10 VDC.*1		Input resistance: 10 kΩ (±1 kΩ), Maximum permissible voltage: 20 VDC For current input, input resistance: 249 Ω (±5 Ω), permissible maximum current: 30 mA. Current input (initial status) Voltage input	131
4		Frequency setting (current)	Inputting 4 to 20 mADC (or 0 to 5 V, 0 to 10 V) provides the maximum output frequency at 20 mA and makes input and output proportional. This input signal is valid only when the AU signal is ON (terminal 2 input is invalid). Use Pr.267 to switch among input 4 to 20 mA (initial setting), 0 to 5 VDC, and 0 to 10 VDC. Set the voltage/current input switch in the "V" position to select voltage input (0 to 5 V / 0 to 10 V).*1			
5		Frequency setting common	Common terminal for the frequency setting signal input (via terminal 2 or 4). Do not earth (ground).		—	131

*1 Set **Pr.73**, **Pr.267**, and the voltage/current input switch correctly, then input an analog signal in accordance with the setting. Applying a voltage with the voltage/current input switch in the "I" position (current input is selected) or applying a current with the switch in the "V" position (voltage input is selected) could cause component damage of the inverter or analog circuits of output devices. (For the details, refer to page 131.)

◆ Output signal

Type	Terminal symbol	Terminal name	Terminal function description	Rated specification	Refer to page
Relay	A, B, C	Relay output (fault output)	1 changeover contact output that indicates that an inverter's protective function has been activated and the outputs are stopped. Fault: discontinuity across B and C (continuity across A and C), Normal: continuity across B and C (discontinuity across A and C)	Contact capacity: 30 VAC 0.3 A (power factor = 0.4), 30 VDC 0.3 A	126

◆ Communication

Type	Terminal symbol	Terminal name	Terminal function description	Refer to page
RS-485	—	PU connector	The PU connector supports the RS-485 communication. Conforming standard: EIA-485 (RS-485) Transmission format: Multidrop link Communication speed: 4800 to 115200 bps Wiring length: 500 m	163

2.6.2 Control logic (sink/source) change

Switch the control logic of input signals as necessary.

To change the control logic, change the jumper connector position on the control circuit board.

Connect the jumper connector to the connector pin of the desired control logic.

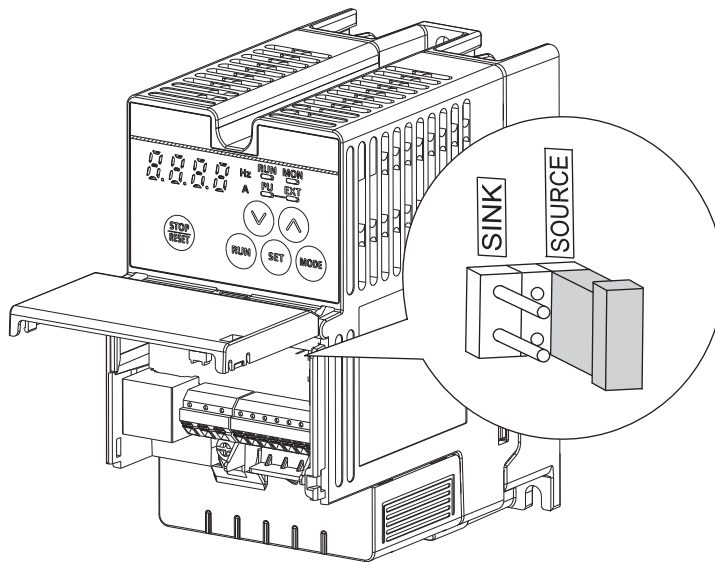

NOTE

- Make sure that the jumper connector is installed correctly.
- Never change the control logic while power is ON.

◆ Sink logic and source logic

- In the sink logic, a signal turns ON when a current exits from the corresponding signal input terminal. Terminal SD is common to the contact input signals.
- In the source logic, a signal turns ON when a current enters into the corresponding signal input terminal. Terminal PC is common to the contact input signals.

●Current flow concerning the input/output signal when sink logic is selected

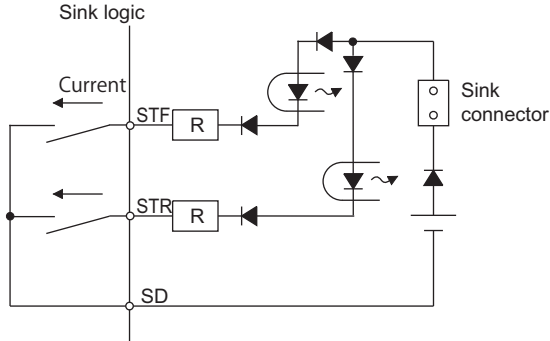

●Current flow concerning the input/output signal when source logic is selected

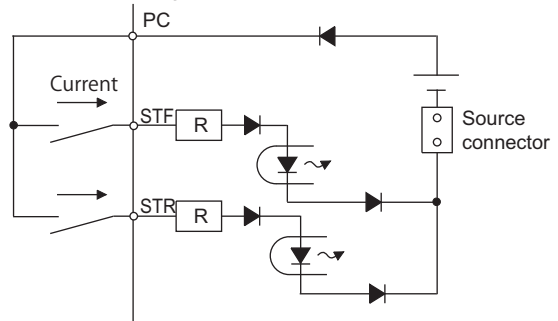

- When using an external power supply for transistor output

Sink logic

Use terminal PC as a common terminal, and perform wiring as follows. (Do not connect terminal SD on the inverter with the terminal of 0 V for the external power supply. When using terminals PC-SD as a 24 VDC power supply, do not install an external power supply in parallel with the inverter. Doing so may cause a malfunction in the inverter due to undesirable currents.)

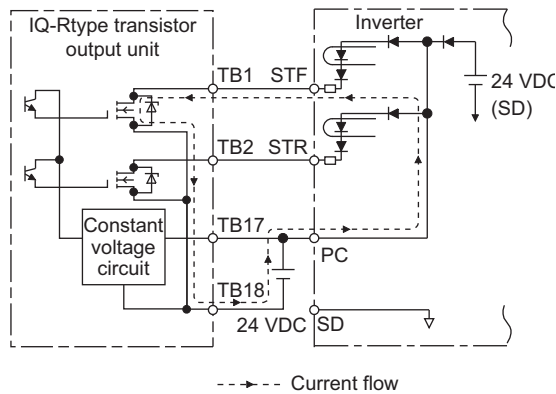

Source logic

Use terminal SD as a common terminal, and perform wiring as follows. (Do not connect terminal PC on the inverter with the terminal of +24 V for the external power supply. When using terminals PC-SD as a 24 VDC power supply, do not install an external power supply in parallel with the inverter. Doing so may cause a malfunction in the inverter due to undesirable currents.)

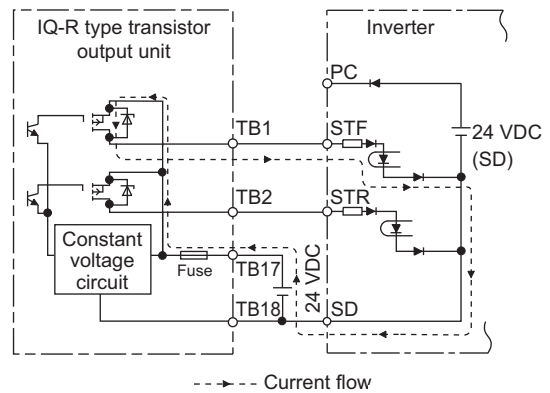

2.6.3 Wiring of control circuit

◆ Control circuit terminal layout

- Recommended cable gauge: 0.3 to 0.75 mm²

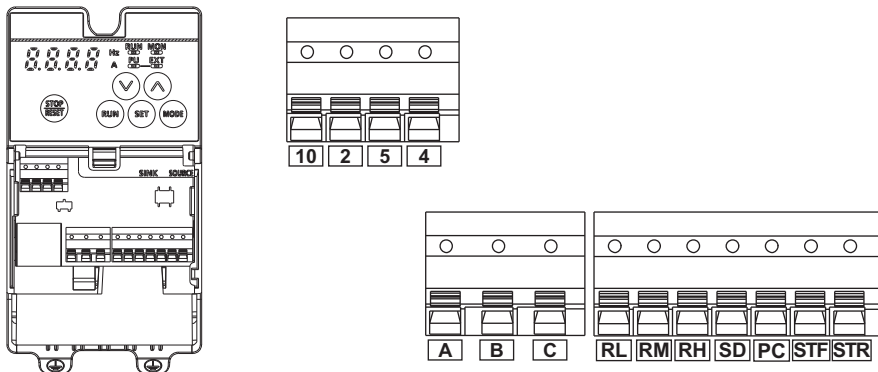

◆ Wiring method

■ Power supply connection

For the control circuit wiring, strip off the sheath of a cable, and use it with a blade terminal. For a single wire, strip off the sheath of the wire and apply directly.

Insert the blade terminal or the single wire into a socket of the terminal.

1. Strip off the sheath for the below length. If the length of the sheath peeled is too long, a short circuit may occur with neighboring wires. If the length is too short, wires might come off.

Wire the stripped cable after twisting it to prevent it from becoming loose. In addition, do not solder it.

Cable sheath stripping length

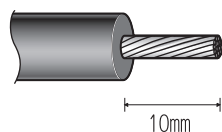

2. Crimp the blade terminal.

Insert wires to a blade terminal, and check that the wires come out for about 0 to 0.5 mm from a sleeve.

Check the condition of the blade terminal after crimping. Do not use a blade terminal of which the crimping is inappropriate, or the face is damaged.

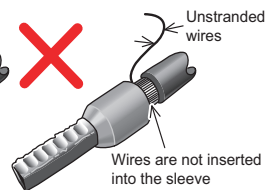
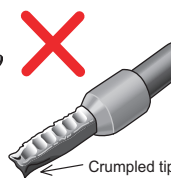
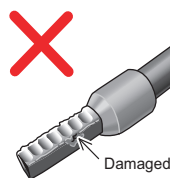
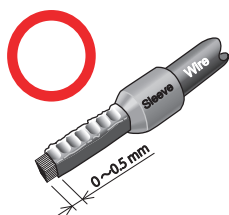

Blade terminals commercially available (as of February 2017)

- Phoenix Contact Co., Ltd.

Cable gauge (mm ²)	Ferrule terminal model			Crimping tool name
	With insulation sleeve	Without insulation sleeve	For UL wire ^{*1}	
0.3	AI 0,34-10TQ	—	—	CRIMPFOX 6
0.5	AI 0,5-10WH	—	AI 0,5-10WH-GB	
0.75	AI 0,75-10GY	A 0,75-10	AI 0,75-10GY-GB	
1	AI 1-10RD	A 1-10	AI 1-10RD/1000GB	
1.25, 1.5	AI 1, 5-10BK	A 1, 5-10	AI 1,5-10BK/1000GB ^{*2}	
0.75 (two-wire product)	AI-TWIN 2×0,75-10GY	—	—	

*1 A ferrule terminal with an insulation sleeve compatible with the MTW wire which has a thick wire insulation.

*2 Applicable for terminals A1, B1, C1, A2, B2, C2.

Cable gauge (mm ²)	Blade terminal product number	Insulation cap product number	Crimping tool product number
0.3 to 0.75	BT 0.75-11	VC 0.75	NH 69

3. Insert the wires into a socket.

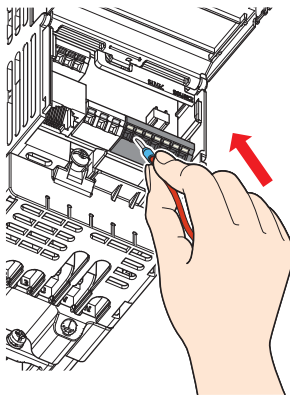

When using a single wire or stranded wires without a blade terminal, push the open/close button all the way down with a flathead screwdriver, and insert the wire.

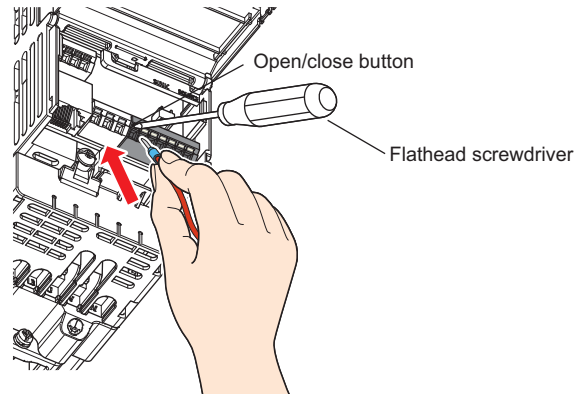

NOTE

- When using stranded wires without a blade terminal, twist enough to avoid short circuit with a nearby terminals or wires.
- Place the flathead screwdriver vertical to the open/close button. In case the blade tip slips, it may cause an inverter damage or injury.

■ Wire removal

Pull the wire while pushing the open/close button all the way down firmly with a flathead screwdriver.

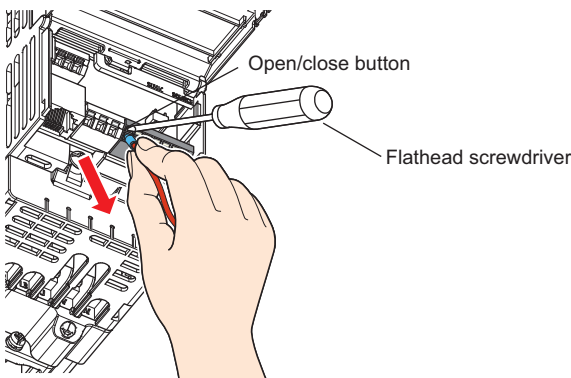

NOTE

- Pulling out the wire forcefully without pushing the open/close button all the way down may damage the terminal block.
- Use a small flathead screwdriver (tip thickness: 0.4 mm / tip width: 2.5 mm).
If a flathead screwdriver with a narrow tip is used, terminal block may be damaged.
- Place the flathead screwdriver vertical to the open/close button. In case the blade tip slips, it may cause an inverter damage or injury.

◆ Common terminals of the control circuit (SD, PC, 5)

- Terminal SD (sink logic) and terminal 5 are common terminals (0 V) for input signals (all common terminals are isolated from each other). Do not earth (ground) these terminals. Avoid connecting the terminal SD with terminal 5 (when sink logic is selected).
- In the sink logic, terminal SD is a common terminal for the contact input terminals (STF, STR, RH, RM, RL). The open collector circuit is isolated from the internal control circuit by photocoupler.
- In the source logic, terminal PC is a common terminal for the contact input terminals (STF, STR, RH, RM, RL). The open collector circuit is isolated from the internal control circuit by photocoupler.

- Terminal 5 is a common terminal for the frequency setting signal input (via terminal 2 or 4). It should be protected from external noise using a shielded or twisted cable.

◆ Signal inputs by contactless switches

The contact input terminals of the inverter (STF, STR, RH, RM, RL) can be controlled using a transistor instead of a contact switch as shown below.

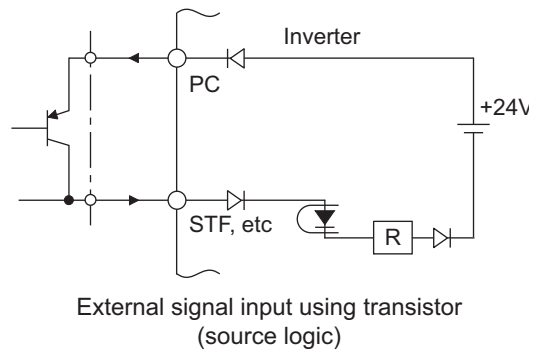
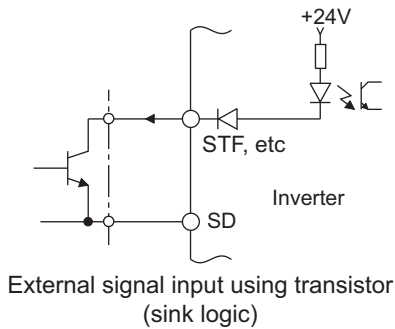

2.6.4 Wiring precautions

- It is recommended to use a cable of 0.3 to 0.75 mm² for the connection to the control circuit terminals.
- The wiring length should be 30 m at the maximum.
- Use two or more parallel micro-signal contacts or twin contacts to prevent contact faults when using contact inputs since the control circuit input signals are micro-currents.

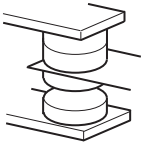

Micro signal contacts

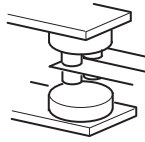

Twin contacts

- To suppress EMI, use shielded or twisted cables for the control circuit terminals and run them away from the main and power circuits (including the 200 V relay sequence circuit). For the cables connected to the control circuit terminals, connect their shields to the common terminal of the connected control circuit terminal. When connecting an external power supply to terminal PC, however, connect the shield of the power supply cable to the negative side of the external power supply. Do not directly earth (ground) the shield to the enclosure, etc.
- Always apply a voltage to the fault output terminals (A, B, C) via a relay coil, lamp, etc.

2.7 Communication connectors and terminals

2.7.1 PU connector

◆ Mounting the operation panel or the parameter unit on the enclosure surface

- Having an operation panel or a parameter unit on the enclosure surface is convenient. With a connection cable, the operation panel or the parameter unit can be mounted to the enclosure surface and connected to the inverter. Use the option FR-CB2[], or connectors and cables available on the market. (To mount the optional LCD operation panel (FR-LU08), the optional connector (FR-ADP) is required.) Securely insert one end of the connection cable until the stoppers are fixed.

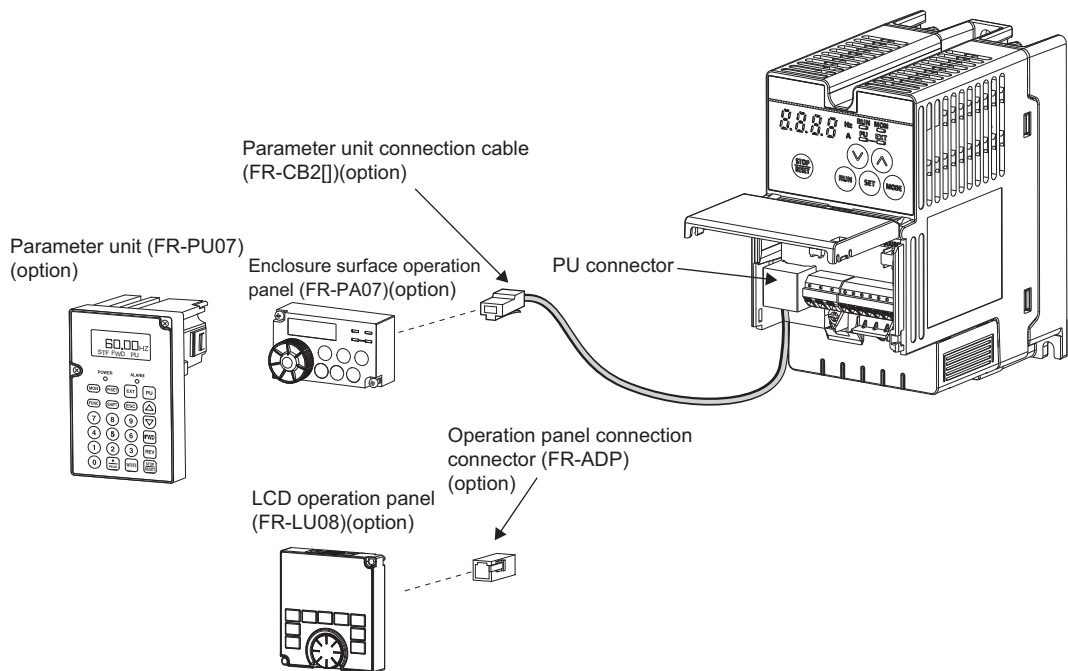

NOTE

- Refer to the following table when fabricating the cable on the user side. Keep the total cable length within 20 m.
- Commercially available products (as of February 2015)

Product	Model	Manufacturer
Communication cable	SGLPEV-T (Cat5e/300 m) 24AWG × 4P	Mitsubishi Cable Industries, Ltd.
RJ-45 connector	5-554720-3	Tyco Electronics

◆ Communication operation

- Using the PU connector as a computer network port enables communication operation from a personal computer, etc. When the PU connector is connected with a personal, FA or other computer by a communication cable, a user program can run to monitor the inverter or read and write parameters. Communication can be performed with the Mitsubishi inverter protocol (computer link operation). For the details, refer to [page 163](#).

2.8 Connection of stand-alone option units

The inverter accepts a variety of stand-alone option units as required.

Incorrect connection will cause inverter damage or accident. Connect and operate the option unit carefully in accordance with the Instruction Manual of the corresponding option unit.

2.8.1 Connection of the brake unit (FR-BU2)

Connect the brake unit (FR-BU2(H)) as follows to improve the braking capability during deceleration.

◆ Connection example with the GRZG type discharging resistor

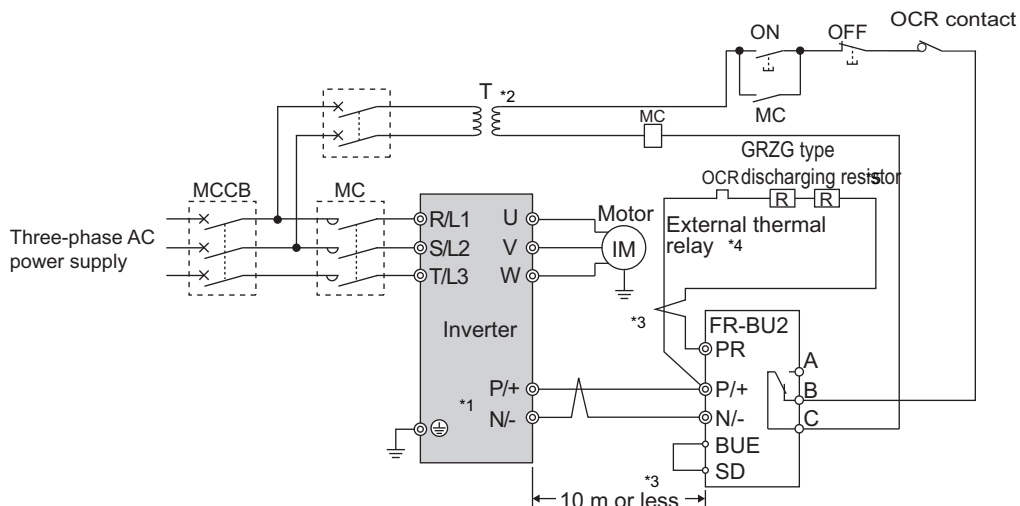

- *1 When wiring, make sure to match the terminal symbol (P/+, N/-) at the inverter side and at the brake unit (FR-BU2) side. (Incorrect connection will damage the inverter and brake unit.)
- *2 When the power supply is 400 V class, install a stepdown transformer.
- *3 The wiring distance between the inverter, ↔brake unit (FR-BU2)↔, and discharging resistor must be within 5 m. Even when the cable is twisted, the wiring length must be within 10 m.
- *4 It is recommended to install an external thermal relay to prevent overheat of the discharging resistor.
- *5 For the connection method of the discharging resistor, refer to the Instruction Manual of the FR-BU2.

- Recommended external thermal relay

Brake unit	Discharging resistor	Recommended external thermal relay
FR-BU2-1.5K	GZG 300W-50Ω (one)	TH-T25-1.3A
FR-BU2-3.7K	GRZG 200-10Ω (three in series)	TH-T25-3.6A
FR-BU2-7.5K	GRZG 300-5Ω (four in series)	TH-T25-6.6A
FR-BU2-15K	GRZG 400-2Ω (six in series)	TH-T25-11A
FR-BU2-H7.5K	GRZG 200-10Ω (six in series)	TH-T25-3.6A
FR-BU2-H15K	GRZG 300-5Ω (eight in series)	TH-T25-6.6A
FR-BU2-H30K	GRZG 400-2Ω (twelve in series)	TH-T25 11A

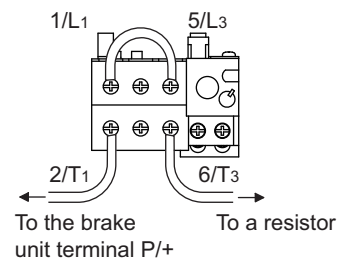

NOTE

- Set "1" in **Pr.0 Brake mode selection** in the FR-BU2 to use a GRZG type discharging resistor.

◆ Connection example with the FR-BR-(H) resistor unit

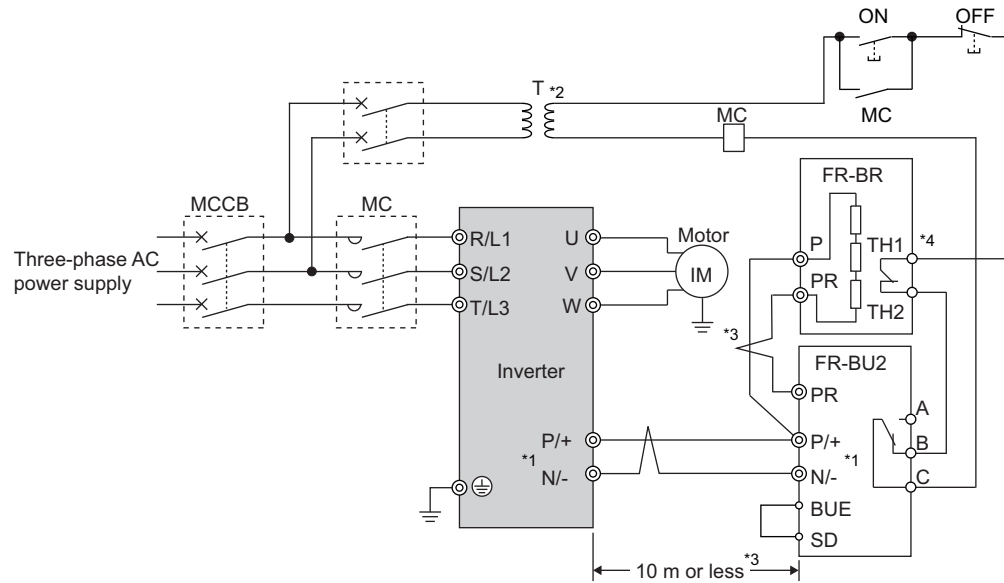

- *1 When wiring, make sure to match the terminal symbol (P/+, N/-) at the inverter side and at the brake unit (FR-BU2) side. (Incorrect connection will damage the inverter and brake unit.)
- *2 When the power supply is 400 V class, install a stepdown transformer.
- *3 The wiring distance between the inverter, ↔brake unit (FR-BU2)↔ and resistor unit (FR-BR) must be within 5 m. Even when the cable is twisted, the wiring length must be within 10 m.
- *4 The contact between TH1 and TH2 is closed in the normal status and is open at a fault.

2.8.2 Connection of the high power factor converter (FR-HC2)

When connecting the high power factor converter (FR-HC2) to suppress power harmonics, perform wiring securely as follows. Incorrect connection will damage the high power factor converter and the inverter.

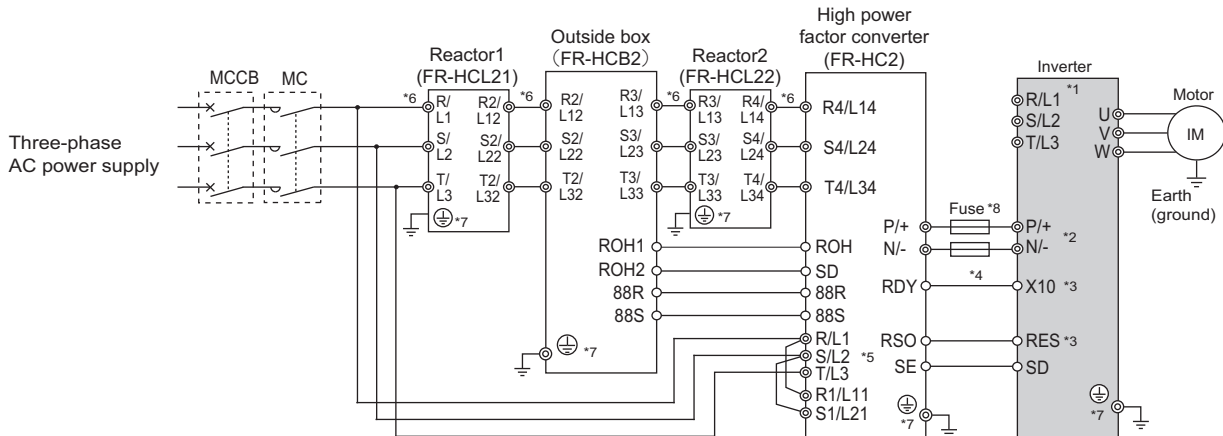

- *1 Do not connect anything to power input terminals (R/L1, S/L2, T/L3). Incorrect connection will damage the inverter.
- *2 Do not install an MCCB across terminals P/+ and N/- (between terminals P and P/+ or between terminals N and N/-). Connecting the opposite polarity of terminals N/- and P/+ will damage the inverter.
- *3 Use **Pr.178 to Pr.182 (Input terminal function selection)** to assign the terminals used for the X10 signal or the RES signal. (Refer to [page 142](#)).
- *4 Always connect terminal RDY on the FR-HC2 to a terminal where the X10 signal or MRS signal is assigned on the inverter. Always connect terminal SE on the FR-HC2 to terminal SD on the inverter. Not connecting these terminals may damage the FR-HC2.
- *5 Always connect terminals R/L1, S/L2, and T/L3 on the FR-HC2 to the power supply. Operating the inverter without connecting them will damage the FR-HC2.
- *6 Do not install an MCCB or MC across terminals (R/L1, S/L2, T/L3) on the reactor 1 and terminals (R4/L14, S4/L24, T4/L34) on the FR-HC2. Doing so disrupts proper operation.
- *7 Securely perform grounding (earthing) by using the grounding (earthing) terminal.
- *8 Installation of a fuse is recommended. (Refer to the Instruction Manual of the FR-HC2.)

NOTE

- The voltage phases of terminals R/L1, S/L2, and T/L3 and the voltage phases of terminals R4/L14, S4/L24, and T4/L34 must be matched.
- The control logic (sink logic/source logic) of the high power factor converter and the inverter must be matched. (Refer to [page 36](#)).

2.8.3 Connection of the power regeneration common converter (FR-CV)

When wiring for connecting the power regeneration common converter (FR-CV) to the inverter, make sure to match the terminal symbols (P/+, N/-) on the inverter and on the power regeneration common converter.

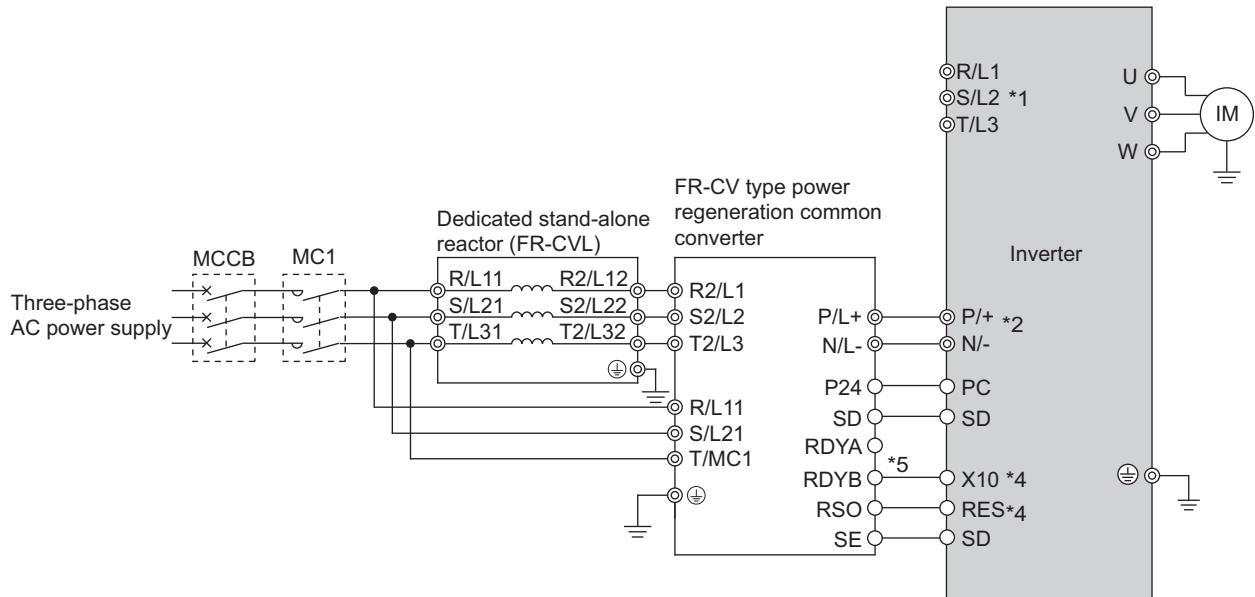

*1 Do not connect anything to power input terminals (R/L1, S/L2, T/L3). Incorrect connection will damage the inverter.

*2 Do not install an MCCB across terminals P/+ and N/- (between terminals P/L+ and P/+ or between N/L- and N/-). Connecting the opposite polarity of terminals N/- and P/+ will damage the inverter.

*3 Be sure to connect the power supply and terminals R/L11, S/L21, and T/MC1. Operating the inverter without connecting them will damage the power regeneration common converter.

*4 Use **Pr.178 to Pr.182 (Input terminal function selection)** to assign the terminals used for the X10 signal or the RES signal. (Refer to [page 142](#)).

*5 Always connect terminal RDY on the FR-HC2 to a terminal where the X10 signal or MRS signal is assigned on the inverter. Always connect terminal SE on the FR-HC2 to terminal SD on the inverter. Not connecting these terminals may damage the FR-CV.

NOTE

- The voltage phases of terminals R/L11, S/L21, and T/MC1 and the voltage phases of terminals R2/L1, S2/L2, and T2/L3 must be matched.
- Use the sink logic when the FR-CV is connected. It cannot be connected when the source logic is selected (factory setting).
- Do not connect a DC reactor (FR-HEL) to the inverter when the FR-CV is connected.

MEMO

CHAPTER 3 PRECAUTIONS FOR USE OF THE INVERTER

3.1	Electro-magnetic interference (EMI) and leakage currents	48
3.2	Power supply harmonics.....	53
3.3	Installation of a reactor	57
3.4	Power shutdown and magnetic contactor (MC).....	58
3.5	Countermeasures against deterioration of the 400 V class motor insulation.....	59
3.6	Checklist before starting operation	60
3.7	Failsafe system which uses the inverter	62

3 PRECAUTIONS FOR USE OF THE INVERTER

This chapter explains the precautions for use of this product.
Always read the instructions before use.

3.1 Electro-magnetic interference (EMI) and leakage currents

3.1.1 Leakage currents and countermeasures

Capacitances exist between the inverter I/O cables, other cables and earth and in the motor, through which a leakage current flows. Since its value depends on the static capacitances, carrier frequency, etc., low acoustic noise operation at the increased carrier frequency of the inverter will increase the leakage current. Therefore, take the following countermeasures. Select the earth leakage current breaker according to its rated sensitivity current, independently of the carrier frequency setting.

◆ To-earth (ground) leakage currents

Leakage currents may flow not only into the inverter's own line but also into the other lines through the earthing (grounding) cable, etc. These leakage currents may operate earth leakage circuit breakers and earth leakage relays unnecessarily.

■ Countermeasures

- If the carrier frequency setting is high, decrease the **Pr.72 PWM frequency selection** setting.
Note that motor noise increases. Selecting **Pr.240 Soft-PWM operation selection** makes the sound inoffensive.
- By using earth leakage circuit breakers designed for harmonic and surge suppression in the inverter's own line and other line, operation can be performed with the carrier frequency kept high (with low noise).

NOTE

- Long wiring will increase the leakage current.
- High motor capacity will increase the leakage current. The leakage current of the 400 V class is larger than that of the 200 V class.

◆ Line-to-line leakage currents

Harmonics of leakage currents flowing in static capacitances between the inverter output cables may operate the external thermal relay unnecessarily. When the wiring length is long (50 m or more) for the 400 V class small-capacity models, the external thermal relay is likely to operate unnecessarily because the ratio of the leakage current to the rated motor current increases.

■ Line-to-line leakage current example (400 V class)

Motor capacity (kW)	Rated motor current(A)	Leakage current (mA)		Condition
		Wiring length 50 m	Wiring length 100 m	
0.4	1.1	620	1000	• Motor: SF-JR 4P • Carrier frequency: 14.5 kHz • Cable: 2 mm ² , 4 cores • Cabtyre cable
0.75	1.9	680	1060	
1.5	3.5	740	1120	
2.2	4.1	800	1180	
3.7	6.4	880	1260	
5.5	9.7	980	1360	
7.5	12.8	1070	1450	

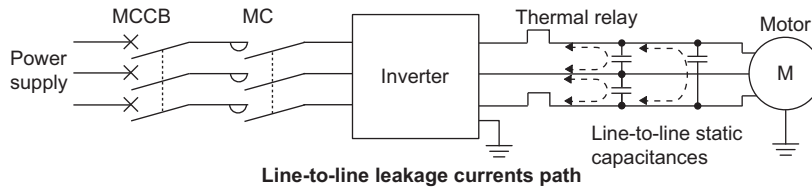

Countermeasure

- Use **Pr.9 Electronic thermal O/L relay**.
- If the carrier frequency setting is high, decrease the **Pr.72 PWM frequency selection** setting.
Note that motor noise increases. Selecting **Pr.240 Soft-PWM operation selection** makes the sound inoffensive.
To ensure that the motor is protected against line-to-line leakage currents, it is recommended to use a temperature sensor to directly detect motor temperature.

Installation and selection of the molded case circuit breaker

Install a molded case circuit breaker (MCCB) on the power receiving side to protect the wiring at the inverter input side. Select an MCCB according to the inverter input side power factor, which depends on the power supply voltage, output frequency and load. Especially for a completely electromagnetic MCCB, a slightly large capacity must be selected since its operation characteristic varies with harmonic currents. (Check it in the data of the corresponding breaker.) As an earth leakage current breaker, use the Mitsubishi earth leakage current breaker designed for harmonics and surge suppression.

Selecting the rated sensitivity current for the earth leakage circuit breaker

When using an earth leakage circuit breaker with the inverter circuit, select its rated sensitivity current as follows, independently of the PWM carrier frequency.

- Breaker designed for harmonic and surge suppression
Rated sensitivity current
 $I_{\Delta n} \geq 10 \times (I_{g1} + I_{gn} + I_{gi} + I_{g2} + I_{gm})$
- Standard breaker
Rated sensitivity current
 $I_{\Delta n} \geq 10 \times \{I_{g1} + I_{gn} + I_{gi} + 3 \times (I_{g2} + I_{gm})\}$

Example of leakage current of cable path per 1km during the commercial power supply operation when the CV cable is routed in metal conduit (200 V 60 Hz)

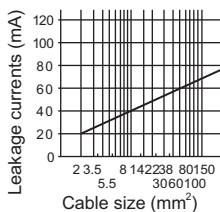

Leakage current example of three-phase induction motor during the commercial power supply operation (200 V 60 Hz)

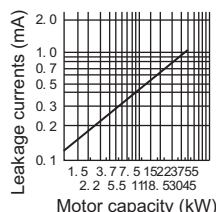

Example of leakage current per 1km during the commercial power supply operation when the CV cable is routed in metal conduit

(Three-phase three-wire delta connection 400 V 60 Hz)

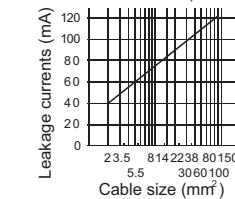

Leakage current example of threephase induction motor during the commercial power supply operation

(Totally-enclosed fan-cooled type motor 400 V 60 Hz)

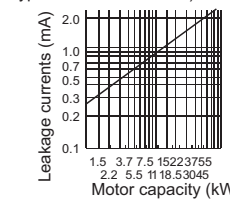

For "Δ" connection, the amount of leakage current is approx. 1/3 of the above value.

Example

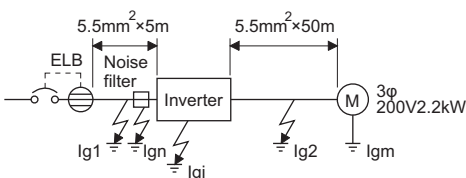

Item	Breaker designed for harmonic and surge suppression	Standard breaker
Leakage current Ig1 (mA)	$33 \times \frac{5m}{1000m} = 0.17$	
Leakage current Ign (mA)	0 (without noise filter)	
Leakage current Igi (mA)	1	
Leakage current Ig2 (mA)	$33 \times \frac{50m}{1000m} = 1.65$	
Motor leakage current Igm (mA)	0.18	
Total leakage current (mA)	3.00	6.66
Rated sensitivity current (mA) ($\geq I_g \times 10$)	30	100

NOTE

- Install the earth leakage circuit breaker (ELB) on the input side of the inverter.
- In the Δ connection earthed-neutral system, the sensitivity current is blunt against a ground fault in the inverter output side. Earthing (grounding) must conform to the requirements of national and local safety regulations and electrical codes. (NEC section 250, IEC 61140 class 1 and other applicable standards)
- When the breaker is installed on the output side of the inverter, it may be unnecessarily operated by harmonics even if the effective value is within the rating.
In this case, do not install the breaker since the eddy current and hysteresis loss will increase, leading to temperature rise.
- The following models are standard breakers: BV-C1, BC-V, NVB, NV-L, NV-G2N, NV-G3NA, NV-2F, earth leakage relay (except NV-ZHA), and NV with AA neutral wire open-phase protection.
The other models are designed for harmonic and surge suppression: NV-C/NV-S/MN series, NV30-FA, NV50-FA, BV-C2, earth leakage alarm breaker (NF-Z), NV-ZHA, and NV-H.

3.1.2 Countermeasures against inverter-generated EMI

Some electromagnetic noises enter the inverter to cause the inverter malfunction, and others are radiated by the inverter to cause the peripheral devices to malfunction. Though the inverter is designed to have high immunity performance, it handles low-level signals, so it requires the following basic techniques. Also, since the inverter chops outputs at high carrier frequency, that could generate electromagnetic noises. If these electromagnetic noises cause peripheral devices to malfunction, EMI countermeasures should be taken to suppress noises. These techniques differ slightly depending on EMI paths.

◆ Basic techniques

- Do not run the power cables (I/O cables) and signal cables of the inverter in parallel with each other and do not bundle them.
- Use shielded twisted pair cables for the detector connecting and control signal cables and connect the sheathes of the shielded cables to terminal SD.
- Ground (Earth) the inverter, motor, etc. at one point.

◆ Techniques to reduce electromagnetic noises that enter and cause a malfunction of the inverter (EMI countermeasures)

When devices that generate many electromagnetic noises (which use magnetic contactors, electromagnetic brakes, many relays, for example) are installed near the inverter and the inverter may malfunction due to electromagnetic noises, the following countermeasures must be taken:

- Provide surge suppressors for devices that generate many electromagnetic noises to suppress electromagnetic noises.
- Install data line filters to signal cables (refer to [page 52](#)).
- Ground (Earth) the shields of the detector connection and control signal cables with cable clamp metal.

◆ Techniques to reduce electromagnetic noises that are radiated by the inverter to cause the peripheral devices to malfunction (EMI countermeasures)

Inverter-generated noises are largely classified into those radiated by the cables connected to the inverter and inverter main circuits (I/O), those electromagnetically and electrostatically induced to the signal cables of the peripheral devices close to the main circuit power supply, and those transmitted through the power supply cables.

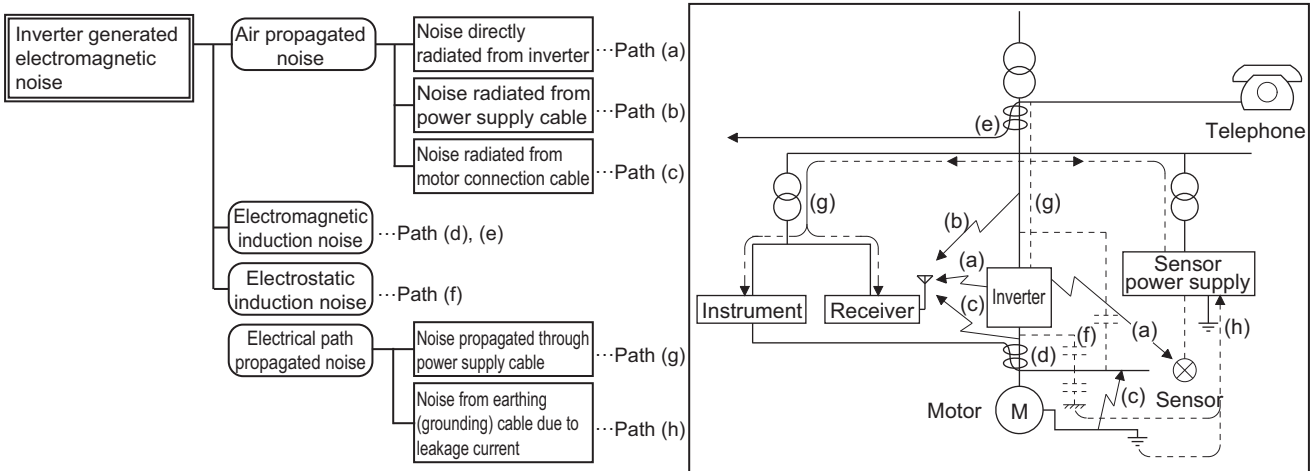

Noise propagation path	Countermeasure
(a), (b), (c)	<p>When devices that handle low-level signals and are liable to malfunction due to electromagnetic noises, e.g. instruments, receivers and sensors, are contained in the enclosure that contains the inverter or when their signal cables are run near the inverter, the devices may malfunction due to by air-propagated electromagnetic noises. The following countermeasures must be taken:</p> <ul style="list-style-type: none"> • Install easily affected devices as far away as possible from the inverter. • Run easily affected signal cables as far away as possible from the inverter and its I/O cables. • Do not run the signal cables and power cables (inverter I/O cables) in parallel with each other and do not bundle them. • Inserting a line noise filter into the output suppresses the radiated noise from the cables. • Use shielded cables as signal cables and power cables and run them in individual metal conduits to produce further effects.
(d), (e), (f)	<p>When the signal cables are run in parallel with or bundled with the power cables, magnetic and static induction noises may be propagated to the signal cables to cause malfunction of the devices and the following countermeasures must be taken:</p> <ul style="list-style-type: none"> • Install easily affected devices as far away as possible from the inverter. • Run easily affected signal cables as far away as possible from the inverter and its I/O cables. • Do not run the signal cables and power cables (inverter I/O cables) in parallel with each other and do not bundle them. • Use shielded cables as signal cables and power cables and run them in individual metal conduits to produce further effects.
(g)	<p>When the power supplies of the peripheral devices are connected to the power supply of the inverter in the same line, inverter-generated noises may flow back through the power supply cables to cause malfunction of the devices and the following countermeasures must be taken:</p> <ul style="list-style-type: none"> • Install the line noise filter (FR-BLF or FR-BSF01) to the power cables (output cables) of the inverter.
(h)	<p>When a closed loop circuit is formed by connecting the peripheral device wiring to the inverter, leakage currents may flow through the earthing (grounding) cable of the inverter to cause the device to malfunction. In that case, disconnecting the earthing (grounding) cable from the device may stop the malfunction of the device.</p>

■ Data line filter

Data line filter is effective as an EMI countermeasure. Provide a data line filter for the detector cable, etc.

- Commercially available data line filter: ZCAT3035-1330 (by TDK), ESD-SR-250 (by NEC TOKIN)
- Specification example (ZCAT3035-1330 by TDK)

Item	Description	
Impedance (Ω)	10 to 100 MHz	80
	100 to 500 MHz	150
Outline dimension drawings (mm)		

The impedance values above are reference values, and not guaranteed values.

■ EMI countermeasure example

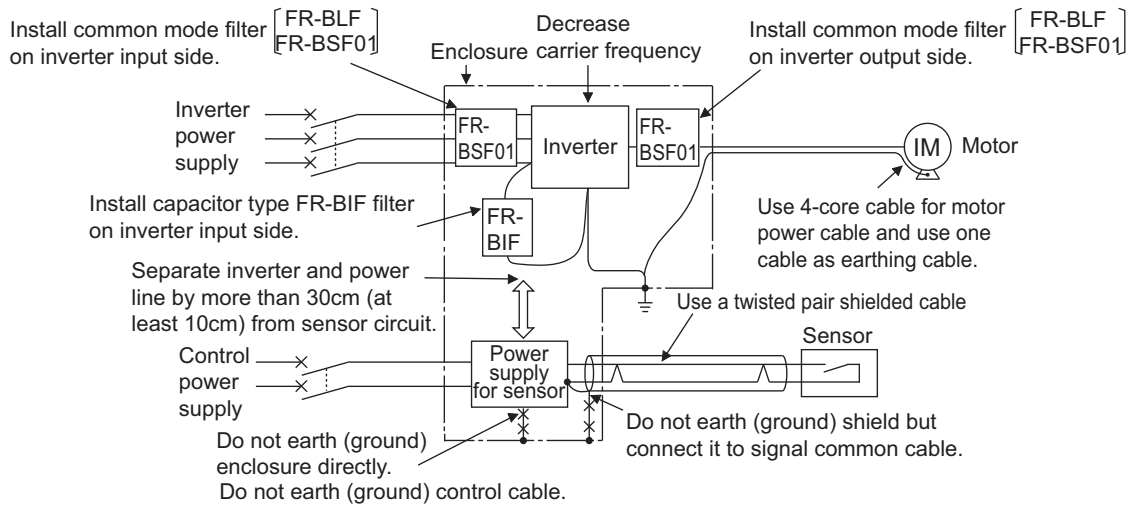

NOTE

- For compliance with the EU EMC Directive, refer to the FREQROL-CS80 Instructions and Cautions for Use of Inverters.

3.2 Power supply harmonics

3.2.1 Power supply harmonics

The inverter may generate power supply harmonics from its converter circuit to affect the power generator, power factor correction capacitor etc. Power supply harmonics are different from noise and leakage currents in source, frequency band and transmission path. Take the following countermeasure suppression techniques.

- Differences between harmonics and noises

Item	Harmonics	Noise
frequency	Normally 40th to 50th degrees or less (3 kHz or less).	High frequency (several 10 kHz to 1 GHz order).
Location	To-electric channel, power impedance.	To-space, distance, wiring path.
Quantitative understanding	Theoretical calculation possible.	Random occurrence, quantitative grasping difficult.
Generated amount	Nearly proportional to the load capacity.	Changes with the current variation ratio. (Gets larger as switching speed increases.)
Affected equipment immunity	Specified by standards per equipment.	Different depending on maker's equipment specifications.
Countermeasure	Provide a reactor.	Increase distance.

- Countermeasures

The harmonic current generated from the inverter to the input side differs according to various conditions such as the wiring impedance, whether a reactor is used or not, and output frequency and output current on the load side.

For the output frequency and output current, we understand that this should be calculated in the conditions under the rated load at the maximum operating frequency.

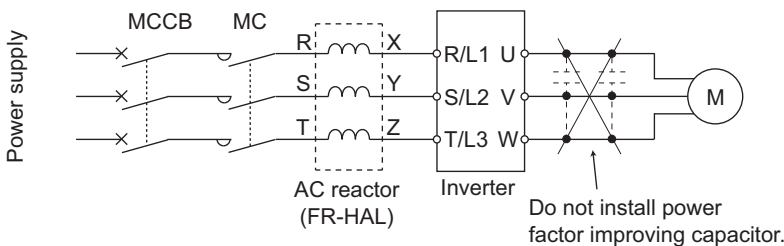

NOTE

- The power factor improving capacitor and surge suppressor on the inverter output side may be overheated or damaged by the harmonic components of the inverter output. Also, since an excessive current flows in the inverter to activate overcurrent protection, do not provide a capacitor and surge suppressor on the inverter output side when the motor is driven by the inverter. For power factor improvement, install a reactor on the inverter input side.

3.2.2 Harmonic suppression guidelines in Japan

Inverters have a converter section (rectifier circuit) and generate a harmonic current.

Harmonic currents flow from the inverter to a power receiving point via a power transformer. The Harmonic Suppression Guidelines was established to protect other consumers from these outgoing harmonic currents.

The three-phase 200 V input specifications 3.7 kW or lower were previously covered by "the Harmonic Suppression Guidelines for Household Appliances and General-purpose Products" and other models were covered by "the Harmonic Suppression Guidelines for Consumers Who Receive High Voltage or Special High Voltage". However, the transistorized inverter has been excluded from the target products covered by "the Harmonic Suppression Guidelines for Household Appliances and General-purpose Products" in January 2004 and "the Harmonic Suppression Guideline for Household Appliances and General-purpose Products" was repealed on September 6, 2004.

All capacity and all models of general-purpose inverter used by specific consumers are now covered by "the Harmonic Suppression Guidelines for Consumers Who Receive High Voltage or Special High Voltage" (hereinafter referred to as "the Specific Consumer Guidelines").

- "Specific Consumer Guidelines"

This guideline sets forth the maximum harmonic currents outgoing from a high-voltage or especially high-voltage receiving consumer who will install, add or renew harmonic generating equipment. If any of the maximum values is exceeded, this guideline requires that consumer to take certain suppression measures.

- Maximum values of outgoing harmonic currents per 1 kW contract power

Received power voltage	5th	7th	11th	13th	17th	19th	23rd	Over 23rd
6.6 kV	3.5	2.5	1.6	1.3	1.0	0.9	0.76	0.70
22 kV	1.8	1.3	0.82	0.69	0.53	0.47	0.39	0.36
33 kV	1.2	0.86	0.55	0.46	0.35	0.32	0.26	0.24

◆ Application of the specific consumer guidelines

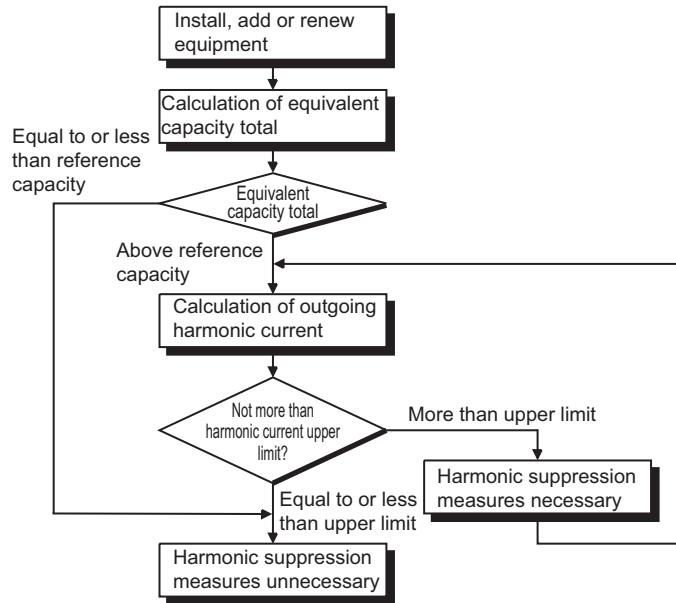

■ Conversion coefficient

Classification	Circuit type	Conversion factor Ki	
3	Three-phase bridge (capacitor smoothing)	Without reactor	K31 = 3.4
		With reactor (AC side)	K32 = 1.8
		With reactor (DC side)	K33 = 1.8
		With reactors (AC, DC sides)	K34 = 1.4
4	Single-phase bridge (capacitor smoothing, double voltage rectification)	Without reactor	K41 = 2.3
		With reactor (AC side)	K42 = 0.35
	Single-phase bridge (capacitor smoothing, full-wave rectification)	Without reactor	K43 = 2.9
		With reactor (AC side)	K44 = 1.3
5	Self-excitation three-phase bridge	When a high power factor converter is used	K5 = 0

■ Equivalent capacity limit

Received power voltage	Reference capacity
6.6 kV	50 kVA
22/33 kV	300 kVA
66 kV or more	2000 kVA

■ Harmonic content (when the fundamental current is considered as 100%)

	Reactor	5th	7th	11th	13th	17th	19th	23rd	25th
Three-phase bridge (capacitor smoothing)	Not used	65	41	8.5	7.7	4.3	3.1	2.6	1.8
	Used (AC side)	38	14.5	7.4	3.4	3.2	1.9	1.7	1.3
	Used (DC side)	30	13	8.4	5.0	4.7	3.2	3.0	2.2
	Used (AC, DC sides)	28	9.1	7.2	4.1	3.2	2.4	1.6	1.4
Single-phase bridge (capacitor smoothing, double voltage rectification)	Not used	50	24	5.1	4.0	1.5	1.4	—	—
	Used (AC side)	6.0	3.9	1.6	1.2	0.6	0.1	—	—
Single-phase bridge (capacitor smoothing, full-wave rectification)	Not used	60	33.5	6.1	6.4	2.6	2.7	1.5	1.5
	Used (AC side)	31.9	8.3	3.8	3.0	1.7	1.4	1.0	0.7

■ Calculation of equivalent capacity P0 of harmonic generating equipment

"Equivalent capacity" is the capacity of a 6-pulse converter converted from the capacity of consumer's harmonic generating equipment and is calculated by the following equation. If the sum of equivalent capacities is higher than the limit (refer to the list of the equivalent capacity limits), harmonics must be calculated by the equation in next subheading.

$$P_0 = \sum (K_i \times P_i) \text{ [kVA]}$$

K_i: Conversion coefficient (Refer to the list of the conversion factors.)

P_i: Rated capacity of harmonic generating equipment ^{*1} [kVA]

i: Number indicating the conversion circuit type

*1 Rated capacity: Determined by the capacity of the applied motor and found in the table "Rated capacities and outgoing harmonic currents of inverter-driven motors". The rated capacity used here is used to calculate the generated harmonic amount and is different from the power supply capacity required for actual inverter drive.

■ Calculation of outgoing harmonic current

Outgoing harmonic current = fundamental wave current (value converted from received power voltage) × operation ratio × harmonic content

- Operation ratio: actual load factor × operation time ratio during 30 minutes
- Harmonic content: Refer to the list of the harmonic content.

■ Rated capacities and outgoing harmonic currents of inverter-driven motors

Applicable motor (kW)	Fundamental wave current (A)		Fundamental wave current converted from 6.6 kV (mA)	Rated capacity (kVA)	Outgoing harmonic current converted from 6.6 kV (mA) (No reactor, 100% operation ratio)							
	200 V	400 V			5th	7th	11th	13th	17th	19th	23rd	25th
0.4	1.61	0.81	49	0.57	31.85	20.09	4.165	3.773	2.107	1.519	1.274	0.882
0.75	2.74	1.37	83	0.97	53.95	34.03	7.055	6.391	3.569	2.573	2.158	1.494
1.5	5.50	2.75	167	1.95	108.6	68.47	14.20	12.86	7.181	5.177	4.342	3.006
2.2	7.93	3.96	240	2.81	156.0	98.40	20.40	18.48	10.32	7.440	6.240	4.320
3.7	13.0	6.50	394	4.61	257.1	161.5	33.49	30.34	16.94	12.21	10.24	7.092
5.5	19.1	9.55	579	6.77	376.1	237.4	49.22	44.58	24.90	17.95	15.05	10.42
7.5	25.6	12.8	776	9.07	504.4	318.2	65.96	59.75	33.37	24.06	20.18	13.97
11	36.9	18.5	1121	13.1	728.7	459.6	95.29	86.32	48.20	34.75	29.15	20.18
15	49.8	24.9	1509	17.6	980.9	618.7	128.3	116.2	64.89	46.78	39.24	27.16

■ Determining if a countermeasure is required

A countermeasure for harmonics is required if the following condition is satisfied: outgoing harmonic current > maximum value per 1 kW contract power × contract power.

■ Harmonic suppression techniques

No.	Item	Description
1	Reactor installation (FR-HAL)	Install an AC reactor (FR-HAL) on the AC side of the inverter to suppress outgoing harmonic currents.
2	High power factor converter (FR-HC2)	This converter trims the current waveform to be a sine waveform by switching the rectifier circuit (converter module) with transistors. Doing so suppresses the generated harmonic amount significantly. Connect it to the DC area of an inverter. Use the high power factor converter (FR-HC2) with the accessories that come as standard.
3	Installation of power factor improving capacitor	When used with a reactor connected in series, the power factor improving correction capacitor can absorb harmonic currents.
4	Transformer multi-phase operation	When two transformers are installed with a phase angle difference of 30° in λ and Δ connection or Δ and Δ connection, the combination of the two transformers are equivalent to a 12-phase rectifier, reducing low-degree harmonic currents.
5	Passive filter (AC filter)	A capacitor and a reactor are used together to reduce impedances at specific frequencies. Harmonic currents are expected to be absorbed greatly by using this technique.
6	Active filter (Active filter)	This filter detects the current in a circuit generating a harmonic current and generates a harmonic current equivalent to a difference between that current and a fundamental wave current to suppress the harmonic current at the detection point. Harmonic currents are expected to be absorbed greatly by using this technique.

3.3 Installation of a reactor

When the inverter is connected near a large-capacity power transformer (500 kVA or more) or when a power factor correction capacitor is to be switched over, an excessive peak current may flow in the power input circuit, damaging the converter circuit. To prevent this, always install an AC reactor (FR-HAL), which is available as an option.

- Three-phase power input

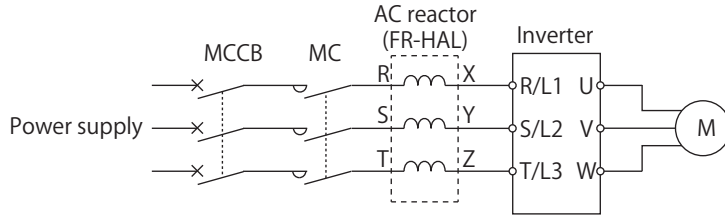

- Single-phase power input

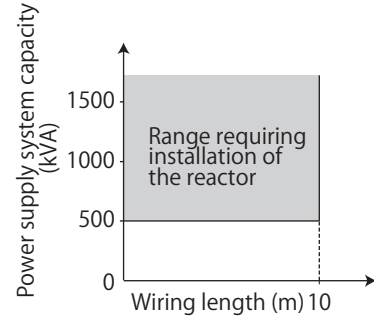
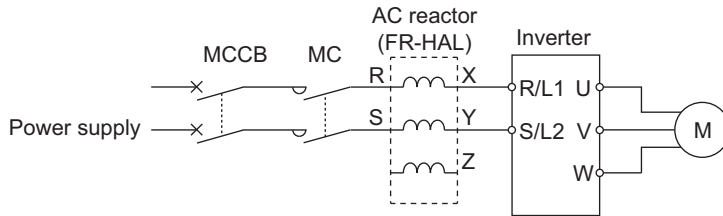

3.5 Countermeasures against deterioration of the 400 V class motor insulation

In the PWM type inverter, a surge voltage attributable to wiring constants is generated at the motor terminals. Especially in a 400 V class motor, the surge voltage may deteriorate the insulation. When the 400 V class motor is driven by the inverter, consider the following countermeasures:

◆ Countermeasures (with induction motor)

It is recommended to take one of the following countermeasures:

■ Rectifying the motor insulation and limiting the PWM carrier frequency according to the wiring length

For the 400 V class motor, use an insulation-enhanced motor.

Specifically,

- Order a "400 V class inverter-driven insulation-enhanced motor".
- For the dedicated motor such as the constant-torque motor and low-vibration motor, use an "inverter-driven dedicated motor".
- Set **Pr.72 PWM frequency selection** as indicated below according to the wiring length.

	Wiring length	
	Shorter than 50 m	50 to 100 m
Pr.72 PWM frequency selection	Any setting	8 (8 kHz) or lower

■ Suppressing the surge voltage on the inverter side

- Connect the surge voltage suppression filter (FR-ASF-H/FR-BMF-H) to the output side.

NOTE

- For the details of the surge voltage suppression filter (FR-ASF-H/FR-BMF-H), refer to the Instruction Manual of each option.

3.6 Checklist before starting operation

The FREQROL-CS80 series inverter is a highly reliable product, but incorrect peripheral circuit making or operation/handling method may shorten the product life or damage the product. Before starting operation, always recheck the following points.

Checkpoint	Countermeasure	Refer to page	Check by user
Crimp terminals are insulated.	Use crimp terminals with insulation sleeves to wire the power supply and the motor.	—	
The wiring between the power supply (terminals R/L1, S/L2, T/L3) and the motor (terminals U, V, W) is correct.	Application of power to the output terminals (U, V, W) of the inverter will damage the inverter. Never perform such wiring.	31	
No wire offcuts are left from the time of wiring.	Wire offcuts can cause an alarm, failure or malfunction. Always keep the inverter clean. When drilling mounting holes in an enclosure etc., take caution not to allow chips and other foreign matter to enter the inverter.	—	
The main circuit cable gauge is correctly selected.	Use an appropriate cable gauge to suppress the voltage drop to 2% or less. If the wiring distance is long between the inverter and motor, a voltage drop in the main circuit will cause the motor torque to decrease especially during the output of a low frequency.	32	
The total wiring length is within the specified length.	Keep the total wiring length within the specified length. In long distance wiring, charging currents due to stray capacitance in the wiring may degrade the fast-response current limit operation or cause the equipment on the inverter's output side to malfunction. Pay attention to the total wiring length.	32	
Countermeasures are taken against EMI.	The input/output (main circuit) of the inverter includes high frequency components, which may interfere with the communication devices (such as AM radios) used near the inverter. In such a case, install the optional radio noise filter FR-BIF (for use in the input side only) or the optional line noise filter FR-BSF01 or FR-BLF to minimize interference.	52	
On the inverter's output side, there is no power factor correction capacitor, surge suppressor, or radio noise filter installed.	Doing so will shut off the inverter output or damage the capacitor or surge suppressor. If any of the above devices is connected, immediately remove it.	—	
When performing an inspection or rewiring on the product that has been energized, the operator has waited long enough after shutting off the power supply.	For a short time after the power-OFF, a high voltage remains in the smoothing capacitor, and it is dangerous. Before performing an inspection or rewiring, wait 10 minutes or longer after the power supply turns OFF, then confirm that the voltage across the main circuit terminals P/+ and N/- of the inverter is low enough using a tester, etc.	—	
The inverter's output side has no short circuit or ground fault occurring.	<ul style="list-style-type: none"> • A short circuit or ground fault on the inverter's output side may damage the inverter module. • Fully check the insulation resistance of the circuit prior to inverter operation since repeated short circuits caused by peripheral circuit inadequacy or an earth (ground) fault caused by wiring inadequacy or reduced motor insulation resistance may damage the inverter module. • Fully check the to-earth (ground) insulation and phase-to-phase insulation of the inverter's output side before power-ON. Especially for an old motor or use in hostile atmosphere, securely check the motor insulation resistance, etc. 	—	
The circuit is not configured to use the inverter's input-side magnetic contactor to start/stop the inverter frequently.	Since repeated inrush currents at power ON will shorten the life of the converter circuit, frequent starts and stops of the magnetic contactor must be avoided. Turn ON or OFF the inverter's start (STF/STR) signal to run or stop the inverter.	58	
The voltage applied to the inverter I/O signal circuits is within the specifications.	Application of a voltage higher than the permissible voltage to the inverter I/O signal circuits or opposite polarity may damage the I/O devices. Especially check the wiring to prevent the speed setting potentiometer from being connected incorrectly to short terminals 10 and 5.	35	

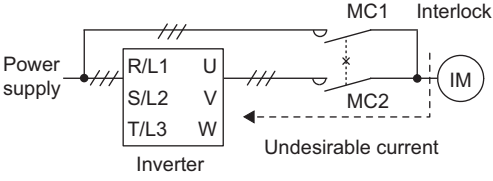
Checkpoint	Countermeasure	Refer to page	Check by user
<p>When using the electronic bypass operation, electrical and mechanical interlocks are provided between the electronic bypass contactors MC1 and MC2.</p>	<p>When using a switching circuit as shown below, chattering due to misconfigured sequence or arc generated at switching may allow undesirable current to flow in and damage the inverter. Miswiring may also damage the inverter.</p>  <p>If switching to the commercial power supply operation while a failure such as an output short circuit has occurred between the magnetic contactor MC2 and the motor, the damage may further spread. If a failure has occurred between the MC2 and the motor, a protection circuit such as using the OH signal input must be provided.</p>	—	
<p>A countermeasure is provided for power restoration after a power failure.</p>	<p>If the machine must not be restarted when power is restored after a power failure, provide an MC in the inverter's input side and also make up a sequence which will not switch ON the start signal. If the start signal (start switch) remains ON after a power failure, the inverter will automatically restart as soon as the power is restored.</p>	—	
<p>A magnetic contactor (MC) is installed on the inverter's input side.</p>	<p>On the inverter's input side, connect an MC for the following purposes:</p> <ul style="list-style-type: none"> • To disconnect the inverter from the power supply at activation of a protective function or at malfunctioning of the driving system (emergency stop, etc.). • To prevent any accident due to an automatic restart at power restoration after an inverter stop made by a power failure. • To separate the inverter from the power supply to ensure safe maintenance and inspection work. <p>To use an MC to perform an emergency stop during operation, select the MC by applying the inverter's input-side current to the rated current specified in the JEM 1038-AC-3 class.</p>	58	
<p>The magnetic contactor on the inverter's output side is properly handled.</p>	<p>Switch the magnetic contactor between the inverter and motor only when both the inverter and motor are at a stop.</p>	58	
<p>An EMI countermeasure is provided for the frequency setting signals.</p>	<p>If electromagnetic noise generated from the inverter causes the frequency setting signal to fluctuate and the motor rotation speed to be unstable when changing the motor speed with analog signals, the following countermeasures are effective:</p> <ul style="list-style-type: none"> • Do not run the signal cables and power cables (inverter I/O cables) in parallel with each other and do not bundle them. • Run the signal cables as far away as possible from the power cables (inverter I/O cables). • Use shielded cables. • Install a data line filter to signal cable (example: ZCAT3035-1330 by TDK). 	50	
<p>A countermeasure is provided for an overload operation.</p>	<p>When performing frequent starts/stops by the inverter, rise/fall in the temperature of the transistor element of the inverter will repeat due to a repeated flow of large current, shortening the life from thermal fatigue. Since thermal fatigue is related to the amount of current, the life can be increased by reducing current at locked condition, starting current, etc. Reducing current may extend the service life but may also cause torque shortage, which leads to a start failure. Adding a margin to the current can eliminate such a condition. For an induction motor, use an inverter of a higher capacity (up to two ranks).</p>	—	
<p>The specifications and rating match the system requirements.</p>	<p>Make sure that the specifications and rating match the system requirements.</p>	238	
<p>Countermeasures are taken against electrical corrosion on the motor bearing.</p>	<p>When a motor is driven by the inverter, axial voltage is generated on the motor shaft, which may cause electrical corrosion of the bearing in rare cases depending on the wiring, load, operating conditions of the motor or specific inverter settings (high carrier frequency, use of a capacitive filter^{*1}). The following shows examples of countermeasures for the inverter.</p> <ul style="list-style-type: none"> • Decrease the carrier frequency. • Remove the capacitive filter. • Provide a common mode choke^{*2} on the output side of the inverter. (This is effective regardless of the use of the capacitive filter.) <p>^{*1} Mitsubishi Electric capacitive filter: FR-BIF, SF[], FR-E5NF-[], FR-S5NFSA[]</p> <p>^{*2} Recommended common mode choke: FT-3KM F series FINEMET® common mode choke cores manufactured by Hitachi Metals, Ltd. FINEMET is a registered trademark of Hitachi Metals, Ltd.</p>	—	

3.7 Failsafe system which uses the inverter

When a fault is detected by the protective function, a fault signal is output. However, a fault signal may not be output at an inverter's fault occurrence when the detection circuit or output circuit fails, etc. Although Mitsubishi assures the best quality products, provide an interlock which uses inverter status output signals to prevent accidents such as damage to the machine when the inverter fails for some reason. Also at the same time consider the system configuration where a failsafe from outside the inverter, without using the inverter, is enabled even if the inverter fails.

◆ Interlock method which uses the inverter status output signals

By combining the inverter output signals to provide an interlock as shown below, an inverter failure can be detected.

No.	Interlock method	Check method	Used signals	Refer to page
a	Inverter protective function operation	Operation check of an alarm contact. Circuit error detection by negative logic.	Fault (ALM) signal	128
b	Inverter operating status	Operation ready signal check.	Operation ready signal (RY) signal	127
c	Inverter running status	Logic check of the start signal and running signal.	Start (STF or STR) signal Running signal (RUN) signal	127, 145
d	Inverter running status	Logic check of the start signal and output current.	Start (STF or STR) signal Output current detection (Y12) signal	129, 145

- When using various signals, refer to the following table and assign the functions by **Pr.195 (Output terminal function selection)**.

Output signal	Pr.195 setting	
	Positive logic	Negative logic
ALM	99	199
RY	11	111
RUN	0	100
Y12	12	112

NOTE

- Changing the terminal assignment using **Pr.195 Output terminal function selection** may affect the other functions. Set parameters after confirming the function of each terminal.

■ Checking by the output of the inverter fault signal ... (a)

When the inverter's protective function is activated and the inverter output is shut off, the Fault (ALM) signal is output. (The ALM signal is assigned to terminals A, B, and C in the initial setting). With this signal, check that the inverter operates properly. In addition, negative logic can be set. (ON when the inverter is normal, OFF when the fault occurs.)

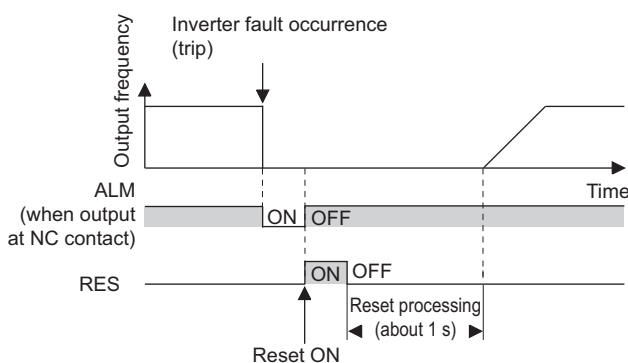

■ Checking the inverter operating status by the Inverter operation ready signal output from the inverter ... (b)

The Inverter operation ready (RY) signal is output when the inverter power is ON and the inverter becomes operative. Check if the RY signal is output after powering ON the inverter.

■ Checking the inverter operating status by the start signal input to the inverter and by the Inverter running signal output from the inverter ... (c)

The Inverter running (RUN) signal is output when the inverter is running. Check if the RUN signal is output while a start signal (the STF/STR signal for forward/reverse rotation command) is input to the inverter. Even after the start signal is turned OFF, the RUN signal is kept output until the inverter makes the motor decelerate and stop. For the logic check, configure a sequence considering the inverter's deceleration time.

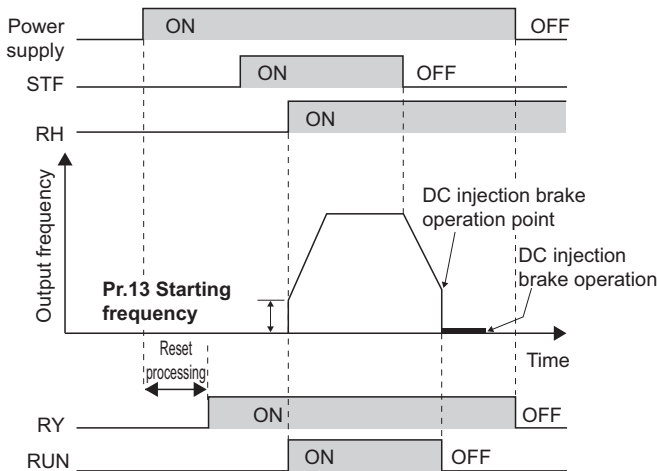

■ Checking the motor operating status by the start signal input to the inverter and by the Output current detection signal output from the inverter ... (d)

The Output current detection (Y12) signal is output when the inverter operates and current flows into the motor.

Check if the Y12 signal is output while a start signal (the STF/STR signal for forward/reverse rotation command) is input to the inverter. The Y12 signal is initially set to be output at 150% rated inverter current. Adjust the level to around 20% using no load current of the motor as reference with **Pr.150 Output current detection level**.

Like the Inverter running (RUN) signal, even after the start signal is turned OFF, the Y12 signal is kept output until the inverter makes the motor decelerate and stop. For the logic check, configure a sequence considering the inverter's deceleration time.

◆ Backup method which does not use the inverter

Even if the interlock is provided by the inverter status signal, enough failsafe is not ensured depending on the failure status of the inverter itself. For example, if an inverter CPU fails in a system interlocked with the inverter's fault, start, and RUN signals, the Fault signal will not be output and the RUN signal will be kept ON because the inverter CPU is down.

Provide a speed detector to detect the motor speed and current detector to detect the motor current and consider the backup system such as performing a check as below according to the level of importance of the system.

■ Start signal and actual operation check

Check the motor running and motor current while the start signal is input to the inverter by comparing the start signal to the inverter and detected speed of the speed detector or detected current of the current detector. Note that the current is flowing through the motor while the motor coasts to stop, even after the inverter's start signal is turned OFF. For the logic check, configure a sequence considering the inverter's deceleration time. In addition, it is recommended to check the three-phase current when using the current detector.

■ Command speed and actual operation check

Check for a gap between the actual speed and commanded speed by comparing the inverter's speed command and the speed detected by the speed detector.

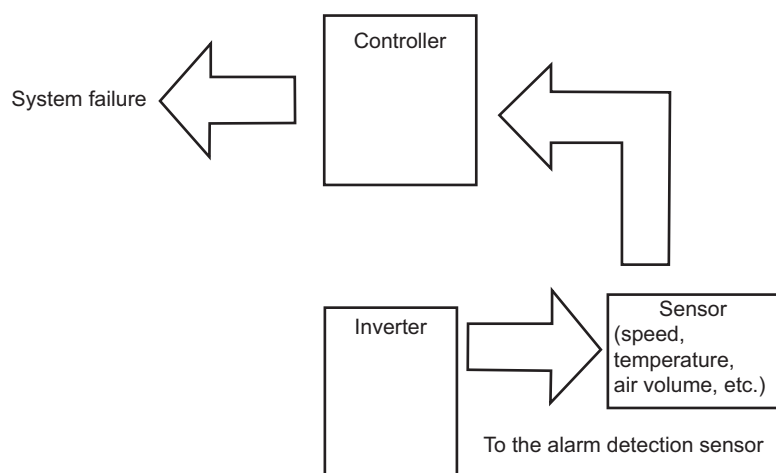

CHAPTER 4 BASIC OPERATION

4.1	Operation panel	66
4.2	Monitoring the inverter	70

4 BASIC OPERATION

This chapter explains the basic operation of this product.
Always read the instructions before use.

4.1 Operation panel

4.1.1 Components of the operation panel

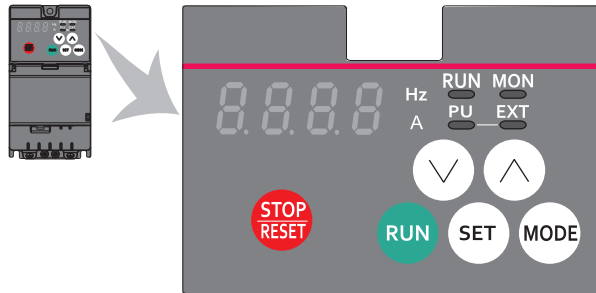

No.	Appearance	Name	Description
(a)		Inverter operation mode LED indicator	PU: ON when the inverter runs in the PU operation mode. EXT: ON when the inverter runs in the External operation mode. (ON when the inverter in the initial setting is powered ON.) PU and EXT: ON when the inverter runs in the External/PU combined operation mode. PU and EXT (blinking): Blinks when the inverter runs in the Network operation mode.
(b)		Operation panel mode LED indicator	ON when the operation panel is in the monitor mode. Quickly blinks twice intermittently while the protective function is activated.
(c)		Inverter operating status indicator	ON or blinks during inverter operation. ON: During forward rotation operation Blinks slowly: During reverse rotation operation Blinks quickly: Operation is disabled although the start command is given.
(d)		Unit indicator	Hz: ON when the actual frequency is monitored. (Blinks when the set frequency is monitored.) A: ON when the current is monitored.
(e)		Monitor display (4-digit LED)	Shows a numeric value (readout) of a monitor item such as the frequency or a parameter number. (The monitor items can be changed according to the settings of Pr.774 to Pr.776.)
(f)		STOP/RESET key	Stops the operation commands. Used to reset the inverter when the protective function is activated.
(i)		UP/DOWN key	Used to change the setting of frequency or parameter, etc. The following operations are also enabled: • Displaying the present setting during calibration • Displaying a fault record number in the fault history
(j)		MODE key	Switches the monitor screen (item) in the monitor mode. Every key on the operation panel becomes inoperable (locks) by holding this key for 2 seconds. The key lock function is disabled when Pr.161 = "0 (initial value)". Holding this key for one second displays the initial screen. (During normal inverter operation it will appear as the first screen in the monitor mode; during abnormal operation it will appear as the first screen in the fault history mode. Reverts to the previous screen if pressed during frequency setting when the easy setting function is enabled..
			Initial setting in monitor mode
(k)		SET key	Confirms each selection. Pressing this key in a mode other than the parameter setting mode will display parameter settings.
(l)		RUN key	Used to give the start command to the inverter. The rotation direction depends on the Pr.40 setting.

4.1.2 Basic operation of the operation panel

◆ Basic operation

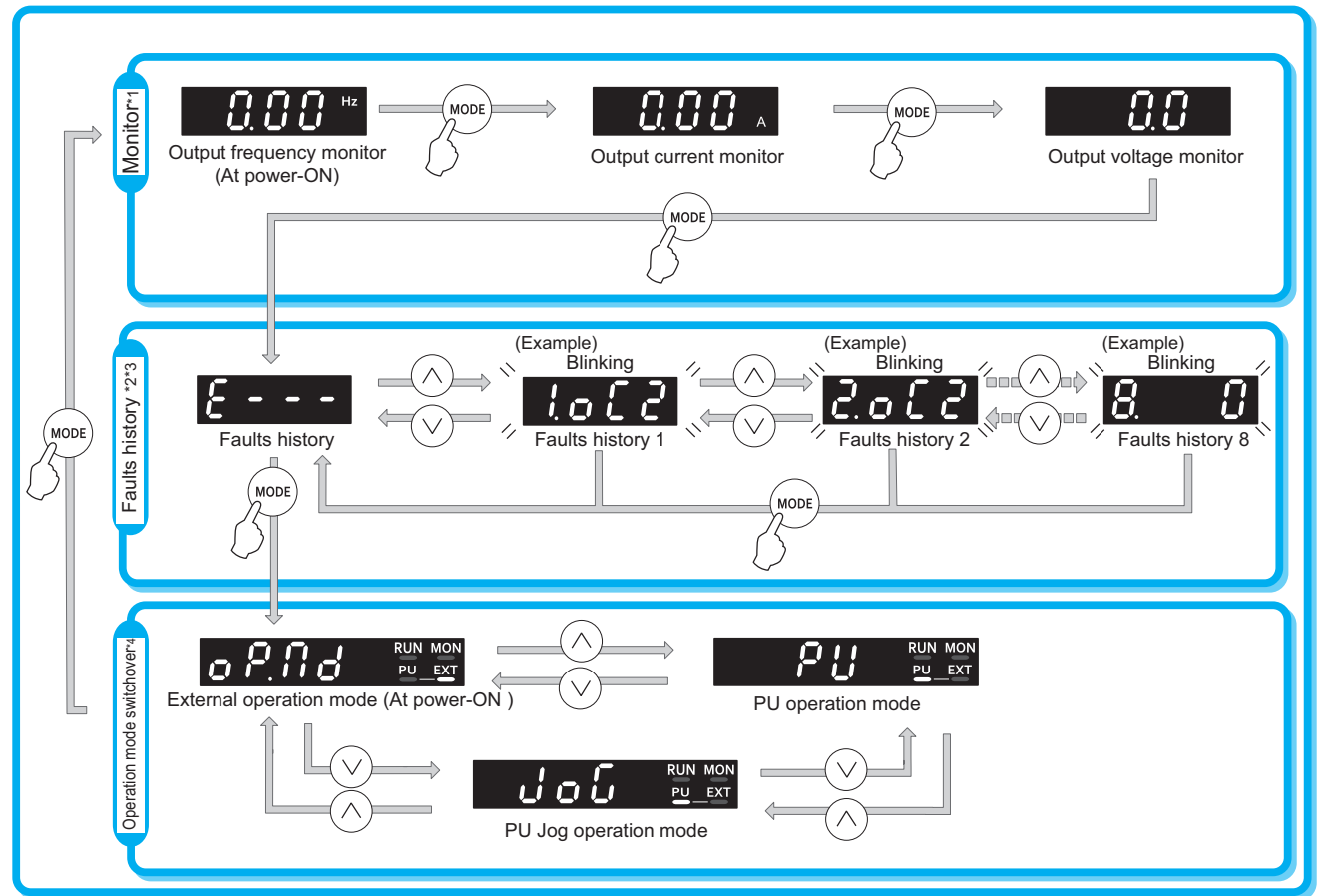

Pressing the MODE key while in the "P. 0" screen returns to the monitor screen.

Pressing the SET key while in any of the screens above will change to the parameter setting screen.

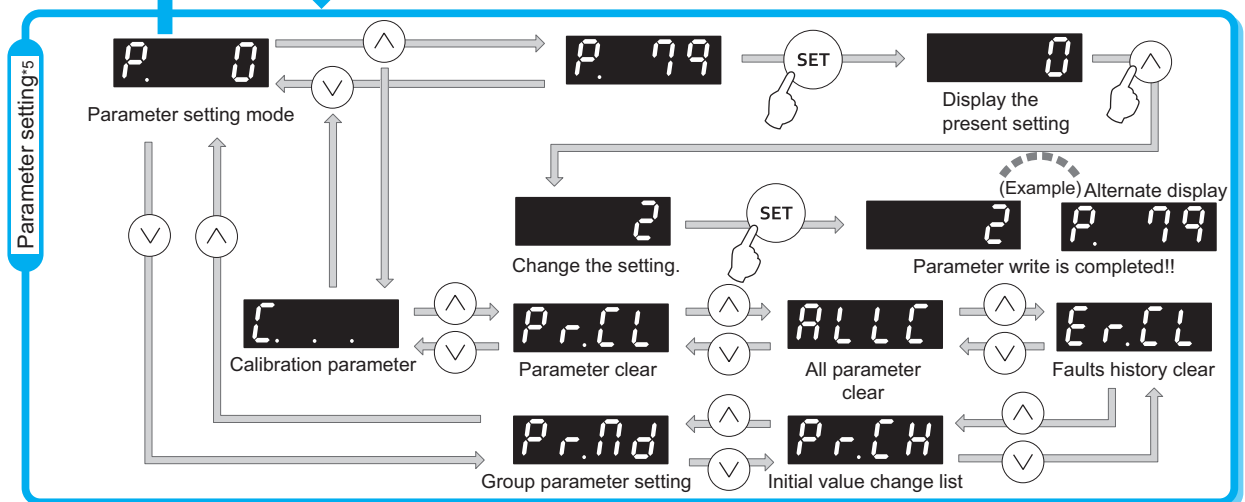

*1 The monitor items can be changed. (Refer to [page 124.](#))

*2 For the details of each fault, refer to [page 211.](#)

*3 In each fault record display, "0" is displayed instead of the fault indication when no fault record exists.

*4 For the details of operation modes, refer to [page 100.](#)

*5 "P. 0" will appear if the MODE key is pressed during parameter setting.

◆ Parameter setting mode

In the parameter setting mode, inverter functions (parameters) are set.

The following table explains the indications in the parameter setting mode.

Operation panel indication	Function name	Description	Refer to page
<i>P.</i>	Parameter setting mode	Under this mode, the set value of the displayed parameter number is read or changed.	69
<i>P.r.CL</i>	Parameter clear	Clears and resets parameter settings to the initial values. Calibration parameters and offline auto tuning parameters are not cleared.	203
<i>ALLC</i>	All parameter clear	Clears and resets parameter settings to the initial values. Calibration parameters and the offline auto tuning parameters are also cleared.	203
<i>E.r.CL</i>	Fault history clear	Deletes the fault history.	208
<i>P.r.CH</i>	Initial value change list	Identifies the parameters that have been changed from their initial settings.	204
<i>P.r.Nd</i>	Group parameter setting	Displays parameter numbers by function groups.	79

4.1.3 Digital characters and their corresponding printed equivalents

Digital characters displayed on the operation panel are as follows.

0	1	2	3	4	5	6	7	8	9	A	B
<i>0</i>	<i>1</i>	<i>2</i>	<i>3</i>	<i>4</i>	<i>5</i>	<i>6</i>	<i>7</i>	<i>8</i>	<i>9</i>	<i>A</i>	<i>b</i>
<i>C</i>	<i>D</i>	<i>E</i>	<i>F</i>	<i>G</i>	<i>H</i>	<i>I</i>	<i>J</i>	<i>K</i>	<i>L</i>	<i>M</i>	<i>N</i>
<i>l</i>	<i>d</i>	<i>E</i>	<i>F</i>	<i>G</i>	<i>H</i>	<i>I</i>	<i>J</i>	<i>K</i>	<i>L</i>	<i>M</i>	<i>N</i>
<i>O</i>	<i>P</i>	<i>Q</i>	<i>R</i>	<i>S</i>	<i>T</i>	<i>U</i>	<i>V</i>	<i>W</i>	<i>X</i>	<i>Y</i>	<i>Z</i>
<i>o</i>	<i>P</i>	<i>q</i>	<i>r</i>	<i>S</i>	<i>T</i>	<i>U</i>	<i>V</i>	<i>W</i>	<i>X</i>	<i>Y</i>	<i>Z</i>

4.1.4 Changing the parameter setting value

Change the setting of Pr.1 Maximum frequency.

Operating procedure

1. Turning ON the power of the inverter
The operation panel is in the monitor mode.
2. Selecting the parameter setting mode
Press **SET** to choose the parameter setting mode.
3. Selecting the parameter
Press **▲** or **▼** to show "Pr. 1" (Pr.1). Press **SET** to read the present set value.
"1200" (initial value) appears.
4. Changing the setting value
Press **▲** or **▼** to change the set value to "5000". Press **SET** to enter the setting. "5000" and "Pr. 1" are displayed alternately.
 - Press **▲** or **▼** to read another parameter.
 - Press **SET** to show the setting again.
 - Press **SET** twice to show the next parameter.
 - Hold **MODE** for one second to return the display to the first screen in the monitor mode (the monitor item initially set in the first screen is the frequency).

NOTE

- If a parameter write condition is not satisfied, a parameter write error appears on the LCD display. (Refer to page 211.)

Error indication	Description
Er 1	Parameter write error
Er 2	Write error during operation
Er 3	Calibration error
Er 4	Mode designation error

- When Pr.77 Parameter write selection = "2 (initial value)", the parameter setting change is available only while the inverter is stopped and under the PU operation mode. To enable the parameter setting change while the inverter is running or under the operation mode other than PU operation mode, change the Pr.77 setting. (Refer to page 89.)



4.2 Monitoring the inverter

4.2.1 Monitoring of output current or output voltage

NOTE

- Press  in the monitor mode to switch the display among three monitoring screens (output frequency, output current, and output voltage are initially set in the first, second, and third screens, respectively).
-

Operating procedure

1. Press  during inverter operation to monitor the output frequency. [Hz] indicator turns ON.
2. Press  to monitor the output current. This operation is valid during running or stopping under any operation mode. [A] indicator turns ON.
3. Press  to monitor the output voltage.

NOTE

- Other item, such as output power or set frequency, can also be monitored. Use Pr.774 Operation panel monitor selection 1 to **Pr.776 Operation panel monitor selection 3** to change the monitor item. (Refer to [page 124.](#))
-

CHAPTER 5 PARAMETERS



5.1	Parameter list.....	72
5.2	Control method	84
5.3	(E) Environment setting parameters	85
5.4	(F) Setting of acceleration/deceleration time and acceleration/deceleration pattern	93
5.5	(D) Operation command and frequency command.....	100
5.6	(H) Protective function parameter	112
5.7	(M) Item and output signal for monitoring	124
5.8	(T) Multi-function input terminal parameters	131
5.9	(C) Motor constant parameters.....	147
5.10	(A) Application parameters	151
5.11	(N) Communication operation parameters.....	163
5.12	(G) Control parameters.....	193
5.13	Parameter clear / All parameter clear	203
5.14	Checking parameters changed from their initial values (initial value change list).....	204

5 PARAMETERS

This chapter explains the function setting for use of this product.

Always read the instructions before use.

The following marks are used to indicate the controls. (Parameters without any mark are valid for all the controls.)

Mark	Control method	Applied motor
	V/F control	Three-phase induction motor
	General-purpose magnetic flux control	

5.1 Parameter list

5.1.1 Parameter list (by parameter number)

For simple variable-speed operation of the inverter, the initial values of the parameters may be used as they are. Set the necessary parameters to meet the load and operational specifications. Parameter setting, change, and check can be made on the operation panel.

NOTE

- The changing of the parameter settings may be restricted in some operating statuses. Use **Pr.77 Parameter write selection** to change the setting.

	Pr.	Pr. group	Name	Setting range	Minimum setting increment	Initial value	Refer to page	Customer setting
Basic function	0	G000	Torque boost	0 to 30%	0.1%	6% ^{*1} 4% ^{*1} 3% ^{*1} 2% ^{*1}	193	
	1	H400	Maximum frequency	0 to 120 Hz	0.01 Hz	120 Hz	117	
	2	H401	Minimum frequency	0 to 120 Hz	0.01 Hz	0 Hz	117	
	3	G001	Base frequency	10 to 400 Hz	0.01 Hz	50 Hz	194	
	4	D301	Multi-speed setting (high speed)	0 to 400 Hz	0.01 Hz	50 Hz	109	
	5	D302	Multi-speed setting (middle speed)	0 to 400 Hz	0.01 Hz	30 Hz	109	
	6	D303	Multi-speed setting (low speed)	0 to 400 Hz	0.01 Hz	10 Hz	109	
	7	F010	Acceleration time	0 to 3600 s	0.1 s	5 s ^{*2} 10 s ^{*2} 15 s ^{*2}	93	
	8	F011	Deceleration time	0 to 3600 s	0.1 s	5 s ^{*2} 10 s ^{*2} 15 s ^{*2}	93	
9	H000	Electronic thermal O/L relay	0 to 500 A	0.01 A	Inverter rated current	112, 147		
DC injection brake	10	G100	DC injection brake operation frequency	0 to 120 Hz	0.01 Hz	3 Hz	197	
	11	G101	DC injection brake operation time	0 to 10 s	0.1 s	0.5 s	197	
	12	G110	DC injection brake operation voltage	0 to 30%	0.1%	4% ^{*3} 2% ^{*4}	197	
—	13	F102	Starting frequency	0 to 60 Hz	0.01 Hz	0.5 Hz	99	

	Pr.	Pr. group	Name	Setting range	Minimum setting increment	Initial value	Refer to page	Customer setting
JOG operation	15	D200	Jog frequency	0 to 400 Hz	0.01 Hz	5 Hz	108	
	16	F002	Jog acceleration/ deceleration time	0 to 3600 s	0.1 s	0.5 s	108	
—	17	T720	MRS input selection	0, 2, 4	1	0	143	
—	18	H402	High speed maximum frequency	120 to 400 Hz	0.01 Hz	120 Hz	117	
—	19	G002	Base frequency voltage	0 to 1000 V, 8888, 9999	0.1 V	8888	194	
Acceleration/deceleration times	20	F000	Acceleration/deceleration reference frequency	1 to 400 Hz	0.01 Hz	50 Hz	93	
Stall prevention	22	H500	Stall prevention operation level	0 to 200%	0.1%	150%	119	
	23	H610	Stall prevention operation level compensation factor at double speed	0 to 200%, 9999	0.1%	9999	119	
Multi-speed setting	24 to 27	D304 to D307	Multi-speed setting (speed 4 to speed 7)	0 to 400 Hz, 9999	0.01 Hz	9999	109	
—	29	F100	Acceleration/deceleration pattern selection	0, 2	1	0	95	
—	30	E300	Regenerative function selection	0, 2	1	0	159	
Frequency jump	31	H420	Frequency jump 1A	0 to 400 Hz, 9999	0.01 Hz	9999	118	
	32	H421	Frequency jump 1B	0 to 400 Hz, 9999	0.01 Hz	9999	118	
	33	H422	Frequency jump 2A	0 to 400 Hz, 9999	0.01 Hz	9999	118	
	34	H423	Frequency jump 2B	0 to 400 Hz, 9999	0.01 Hz	9999	118	
	35	H424	Frequency jump 3A	0 to 400 Hz, 9999	0.01 Hz	9999	118	
36	H425	Frequency jump 3B	0 to 400 Hz, 9999	0.01 Hz	9999	118		
—	40	E202	RUN key rotation direction selection	0, 1	1	0	88	
Frequency detection	41	M441	Up-to-frequency sensitivity	0 to 100%	0.1%	10%	129	
	42	M442	Output frequency detection	0 to 400 Hz	0.01 Hz	6 Hz	129	
	43	M443	Output frequency detection for reverse rotation	0 to 400 Hz, 9999	0.01 Hz	9999	129	
Second function	44	F020	Second acceleration/ deceleration time	0 to 3600 s	0.1 s	5 s ^{*2} 10 s ^{*2} 15 s ^{*2}	93	
	45	F021	Second deceleration time	0 to 3600 s, 9999	0.1 s	9999	93	
Automatic restart	57	A702	Restart coasting time	0, 0.1 to 5 s, 9999	0.1 s	9999	159	
	58	A703	Restart cushion time	0 to 60 s	0.1 s	1 s	159	
—	59	F101	Remote function selection	0 to 3	1	0	96	
—	60	G030	Energy saving control selection	0, 9	1	0	195	

	Pr.	Pr. group	Name	Setting range	Minimum setting increment	Initial value	Refer to page	Customer setting
—	65	H300	Retry selection	0 to 5	1	0	115	
—	66	H611	Stall prevention operation reduction starting frequency	0 to 400 Hz	0.01 Hz	50 Hz	119	
Retry	67	H301	Number of retries at fault occurrence	0 to 10, 101 to 110	1	0	115	
	68	H302	Retry waiting time	0.1 to 600 s	0.1 s	1 s	115	
	69	H303	Retry count display erase	0	1	0	115	
—	71	C100	Applied motor	0 to 2	1	0	147, 147	
—	72	E600	PWM frequency selection	2 to 12	1	2	92	
—	73	T000	Analog input selection	0, 1, 10, 11	1	1	131	
—	74	T002	Input filter time constant	0 to 8	1	1	134	
—	75	—	Reset selection/ disconnected PU detection/ PU stop selection	0 to 3, 14 to 17	1	14	85	
		E100	Reset selection	0, 1		0		
		E101	Disconnected PU detection			1		
		E102	PU stop selection					
—	77	E400	Parameter write selection	0 to 2	1	2	89	
—	78	D020	Reverse rotation prevention selection	0 to 2	1	0	108	
—	79	D000	Operation mode selection	0 to 4	1	0	100, 104	
Motor constant	80	C101	Motor capacity	0.2 to 15 kW, 9999	0.01 kW	9999	147	
	82	C125	Motor excitation current	0 to 500 A, 9999	0.01 A	9999	147	
	90	C120	Motor constant (R1)	0 to 50 Ω, 9999	0.001 Ω	9999	147	
	96	C110	Auto tuning setting/status	0, 1	1	0	147	
Adjustable 3 points V/F	100	G040	V/F1 (first frequency)	0 to 400 Hz, 9999	0.01 Hz	9999	195	
	101	G041	V/F1 (first frequency voltage)	0 to 1000 V	0.1 V	0 V	195	
	102	G042	V/F2 (second frequency)	0 to 400 Hz, 9999	0.01 Hz	9999	195	
	103	G043	V/F2 (second frequency voltage)	0 to 1000 V	0.1 V	0 V	195	
	104	G044	V/F3 (third frequency)	0 to 400 Hz, 9999	0.01 Hz	9999	195	
	105	G045	V/F3 (third frequency voltage)	0 to 1000 V	0.1 V	0 V	195	
PU connector communication	117	N020	PU communication station number	0 to 31(0 to 247)	1	0	168	
	118	N021	PU communication speed	48, 96, 192, 384, 576, 768, 1152	1	192	168	
	119	—	PU communication stop bit length / data length	0, 1, 10, 11	1	1	168	
		N022	PU communication data length	0, 1		0		
		N023	PU communication stop bit length	0, 1		1		
	120	N024	PU communication parity check	0 to 2	1	2	168	
	121	N025	PU communication retry count	0 to 10, 9999	1	1	168	
	122	N026	PU communication check time interval	0, 0.1 to 999.8 s, 9999	0.1 s	0	168	
	123	N027	PU communication waiting time setting	0 to 150 ms, 9999	1 ms	9999	168	
	124	N028	PU communication CR/LF selection	0 to 2	1	1	168	
—	125	T022	Terminal 2 frequency setting gain frequency	0 to 400 Hz	0.01 Hz	50 Hz	134	
—	126	T042	Terminal 4 frequency setting gain frequency	0 to 400 Hz	0.01 Hz	50 Hz	134	

	Pr.	Pr. group	Name	Setting range	Minimum setting increment	Initial value	Refer to page	Customer setting	
PID operation	127	A612	PID control automatic switchover frequency	0 to 400 Hz, 9999	0.01 Hz	9999	152		
	128	A610	PID action selection	0, 20, 21	1	0	152		
	129	A613	PID proportional band	0.1 to 1000%, 9999	0.1%	100%	152		
	130	A614	PID integral time	0.1 to 3600 s, 9999	0.1 s	1 s	152		
	131	A601	PID upper limit	0 to 100%, 9999	0.1%	9999	152		
	132	A602	PID lower limit	0 to 100%, 9999	0.1%	9999	152		
	133	A611	PID action set point	0 to 100%, 9999	0.01%	9999	152		
	134	A615	PID differential time	0.01 to 10 s, 9999	0.01 s	9999	152		
PU	145	E103	PU display language selection	0 to 7	1	1	87		
Current detection	150	M460	Output current detection level	0 to 200%	0.1%	150%	129		
	151	M461	Output current detection signal delay time	0 to 10 s	0.1 s	0 s	129		
—	156	H501	Stall prevention operation selection	0 to 31, 100, 101	1	0	119		
—	157	M430	OL signal output timer	0 to 25 s, 9999	0.1 s	0 s	119		
—	161	E200	Frequency setting / key lock operation selection	0, 1, 10, 11	1	0	88		
Automatic restart	165	A710	Stall prevention operation level for restart	0 to 200%	0.1%	150%	159		
Current detection	167	M464	Output current detection operation selection	0, 1	1	0	129		
—	168	E000 E080	Parameter for manufacturer setting. Do not set.						
—	169	E001 E081							
Cumulative monitor value clear	170	M020	Watt-hour meter clear	0, 10, 9999	1	9999	124		
	171	M030	Operation hour meter clear	0, 9999	1	9999	124		

	Pr.	Pr. group	Name	Setting range	Minimum setting increment	Initial value	Refer to page	Customer setting	
Input terminal function assignment	178	T700	STF terminal function selection	0 to 5, 7, 8, 10, 14, 24, 25, 37, 60, 62, 9999	1	60	142		
	179	T701	STR terminal function selection	0 to 5, 7, 8, 10, 14, 24, 25, 37, 61, 62, 9999	1	61	142		
	180	T702	RL terminal function selection	0 to 5, 7, 8, 10, 14, 24, 25, 37, 62, 9999	1	0	142		
	181	T703	RM terminal function selection		1	1	142		
	182	T704	RH terminal function selection		1	2	142		
Output terminal function assignment	190	M400	NET Y0 terminal function selection	0, 1, 3, 4, 8, 11, 12, 14 to 16, 26, 46, 47, 64, 70, 91, 98, 99, 100, 101, 103, 104, 108, 111, 112, 114 to 116, 126, 146, 147, 164, 170, 191, 198, 199, 9999	1	0	126		
	191	M401	NET Y1 terminal function selection		1	1	126		
	192	M402	NET Y2 terminal function selection		1	3	126		
	193	M403	NET Y3 terminal function selection		1	9999	126		
	194	M404	NET Y4 terminal function selection		1	4	126		
	195	M405	ABC terminal function selection		1	99	126		
Multi-speed setting	232 to 239	D308 to D315	Multi-speed setting (speed 8 to speed 15)	0 to 400 Hz, 9999	0.01 Hz	9999	109		
—	240	E601	Soft-PWM operation selection	0, 1, 10, 11	1	1	92		
Slip compensation	245	G203	Rated slip	0 to 50%, 9999	0.01%	9999	202		
	246	G204	Slip compensation time constant	0.01 to 10 s	0.01 s	0.5 s	202		
	247	G205	Constant-power range slip compensation selection	0, 9999	1	9999	202		
—	249	H101	Earth (ground) fault detection at start	0, 1	1	1	114		
—	250	G106	Stop selection	0 to 100 s, 1000 to 1100 s, 8888, 9999	0.1 s	9999	198		
—	251	H200	Output phase loss protection selection	0, 1	1	1	115		
Power failure stop	261	A730	Power failure stop	0 to 2	1	0	160		
—	267	T001	Terminal 4 input selection	0 to 2	1	0	131		
—	269	E023	Parameter for manufacturer setting. Do not set.						
Password	296	E410	Password lock level	1 to 6, 101 to 106, 9999	1	9999	90		
	297	E411	Password lock/unlock	(0 to 5), 1000 to 9998, 9999	1	9999	90		

	Pr.	Pr. group	Name	Setting range	Minimum setting increment	Initial value	Refer to page	Customer setting	
RS-485 communication	338	D010	Communication operation command source	0, 1	1	0	105		
	339	D011	Communication speed command source	0 to 2	1	0	105		
	340	D001	Communication startup mode selection	0, 1, 10	1	0	104		
	342	N001	Communication EEPROM write selection	0, 1	1	0	165		
	343	N080	Communication error count	—	1	0	182		
—	502	N013	Stop mode selection at communication error	0 to 2	1	0	165		
—	520	E415	Parameter for manufacturer setting. Do not set.						
Communication	549	N000	Protocol selection	0, 1	1	0	165		
	551	D013	PU mode operation command source selection	2, 4, 9999	1	9999	105		
—	573	A680	4 mA input check selection	1 to 3, 9999	1	9999	139		
PID control	575	A621	Output interruption detection time	0 to 3600 s, 9999	0.1 s	1 s	152		
	576	A622	Output interruption detection level	0 to 400 Hz	0.01 Hz	0 Hz	152		
	577	A623	Output interruption cancel level	900 to 1100%	0.1%	1000%	152		
Traverse	592	A300	Traverse function selection	0 to 2	1	0	151		
	593	A301	Maximum amplitude amount	0 to 25%	0.1%	10%	151		
	594	A302	Amplitude compensation amount during deceleration	0 to 50%	0.1%	10%	151		
	595	A303	Amplitude compensation amount during acceleration	0 to 50%	0.1%	10%	151		
	596	A304	Amplitude acceleration time	0.1 to 3600 s	0.1 s	5 s	151		
	597	A305	Amplitude deceleration time	0.1 to 3600 s	0.1 s	5 s	151		
—	598	H105	Undervoltage detection enable/disable selection	0, 1	1	1	115		
—	611	F003	Acceleration time at a restart	0 to 3600 s, 9999	0.1 s	9999	159		
—	631	H104	Inverter output fault detection enable/disable selection	0, 1	1	1	114		
Increased magnetic excitation deceleration	660	G130	Increased magnetic excitation deceleration operation selection	0, 1	1	0	200		
	661	G131	Magnetic excitation increase rate	0 to 40%, 9999	0.1%	9999	200		
	662	G132	Increased magnetic excitation current level	0 to 200%	0.1%	100%	200		
—	665	G125	Regeneration avoidance frequency gain	0 to 200%	0.1%	100%	199		
Monitoring	774	M101	Operation panel monitor selection 1	1 to 3, 5, 8, 10, 14, 20, 23 to 25, 52 to 55, 61, 62, 100	1	1	124		
	775	M102	Operation panel monitor selection 2		1	2	124		
	776	M103	Operation panel monitor selection 3		1	3	124		
—	778	T054	4 mA input check filter	0 to 10 s	0.01 s	0 s	139		
Protective function	872 ^{*5}	H201	Input phase loss protection selection	0, 1	1	1	115		

	Pr.	Pr. group	Name	Setting range	Minimum setting increment	Initial value	Refer to page	Customer setting
Regeneration avoidance	882	G120	Regeneration avoidance operation selection	0 to 2	1	0	199	
	883	G121	Regeneration avoidance operation level	300 to 800 V	0.1 V	400 VDC ^{*6}	199	
						780 VDC ^{*7}		
	885	G123	Regeneration avoidance compensation frequency limit value	0 to 10 Hz, 9999	0.01 Hz	6 Hz	199	
886	G124	Regeneration avoidance voltage gain	0 to 200%	0.1%	100%	199		
Calibration parameter	C2 (902) ^{*8}	T200	Terminal 2 frequency setting bias frequency	0 to 400 Hz	0.01 Hz	0 Hz	134	
	C3 (902) ^{*8}	T201	Terminal 2 frequency setting bias	0 to 300%	0.1%	0%	134	
	125 (903) ^{*8}	T202	Terminal 2 frequency setting gain frequency	0 to 400 Hz	0.01 Hz	50 Hz	134	
	C4 (903) ^{*8}	T203	Terminal 2 frequency setting gain	0 to 300%	0.1%	100%	134	
	C5 (904) ^{*8}	T400	Terminal 4 frequency setting bias frequency	0 to 400 Hz	0.01 Hz	0 Hz	134	
	C6 (904) ^{*8}	T401	Terminal 4 frequency setting bias	0 to 300%	0.1%	20%	134	
	126 (905) ^{*8}	T402	Terminal 4 frequency setting gain frequency	0 to 400 Hz	0.01 Hz	50 Hz	134	
	C7 (905) ^{*8}	T403	Terminal 4 frequency setting gain	0 to 300%	0.1%	100%	134	
PU	990	E104	PU buzzer control	0, 1	1	1	87	
	991	E105	PU contrast adjustment	0 to 63	1	58	88	
Clear parameter	Pr.CL		Parameter clear	(0), 1	1	0	203	
	ALLC		All parameter clear	(0), 1	1	0	203	
	Er.CL		Fault history clear	(0), 1	1	0	208	
—	Pr.CH		Initial value change list	—	1	0	204	
—	Pr.MD		Group parameter setting	(0), 1, 2	1	0	79	

- *1 Differs according to the capacity.
6%: FR-CS84-022 or lower, FR-CS82S-042 or lower
4%: FR-CS84-036 to FR-CS84-080, FR-CS82S-070, FR-CS82S-100
3%: FR-CS84-120 and FR-CS84-160
2%: FR-CS84-230 or higher
- *2 Differs according to the capacity.
5 s: FR-CS84-080 or lower,
10 s: FR-CS84-120 and FR-CS84-160, FR-CS82S-042 or lower
15 s: FR-CS84-230 or higher
- *3 The setting range or initial value for the FR-CS84-160 or lower and FR-CS82S-100 or lower.
*4 The setting range or initial value for the FR-CS84-230 or higher.
*5 Available only for the three-phase power input model.
*6 The value for the 200 V class.
*7 The value for the 400 V class.
*8 The parameter number in parentheses is the one used (displayed) on the LCD operation panel and the parameter unit.







5.1.2 Use of a function group number for the identification of parameters

A parameter identification number shown on the PU can be switched from a parameter number to a function group number. As parameters are grouped by function and displayed by the group, the related parameters can be set continually at a time.

◆ Changing a parameter identification number to a function group number

Pr.MD setting	Description
0	The setting of parameter identification number remains the same as the last setting.
1	The parameter number is used for the identification of parameters, and displayed in numerical order.
2	The function group number is used for the identification of parameters, and displayed in alphanumeric order.











Operating procedure

- 1.** Turning ON the power of the inverter
The operation panel is in the monitor mode.
- 2.** Selecting the parameter setting mode
Press  to choose the parameter setting mode.
- 3.** Selecting a parameter
Press  or  until "Pr.Md" (Group parameter setting) appears.
Press  to confirm the selection. The setting "0" (initial value)" will appear.
- 4.** Selecting the use of the function group number
Press  or  to change the set value to "2" (function group number). Press  to select the Group parameter setting. "2" and "Pr.Md" are displayed alternately after the setting is completed.

◆ Selecting a parameter by function group number to change its setting

The following shows the procedure to change the setting of P.H400 (Pr.1) Maximum frequency.

Operating procedure

- 1.** Turning ON the power of the inverter
The operation panel is in the monitor mode.
- 2.** Selecting the parameter setting mode
Press  to choose the parameter setting mode.
- 3.** Enabling the function group selection
Press  or  until "H . . ." (Protective function parameter) appears. Press  to confirm the selection.
"H - - -" will appear, which shows that the operation panel is ready for selection of a number in the group of Protective function parameter.
- 4.** Selecting a parameter
Press  or  until "H400" (P.H400 Maximum frequency) appears. Press  to display the present set value. "1200" (initial value) appears.
- 5.** Changing the setting value
Press  or  to change the set value to "6000". Press  to confirm the selection. "6000" and "H400" are displayed alternately after the setting is completed.

5.1.3 Parameter list (by function group number)

◆ E: Environment setting parameters

Parameters for the inverter operating environment.

Pr. group	Pr.	Name	Refer to page
E000	168	Parameter for manufacturer setting. Do not set.	
E001	169	Parameter for manufacturer setting. Do not set.	
E023	269	Parameter for manufacturer setting. Do not set.	
E080	168	Parameter for manufacturer setting. Do not set.	
E081	169	Parameter for manufacturer setting. Do not set.	
E100	75	Reset selection	85
E101	75	Disconnected PU detection	85
E102	75	PU stop selection	85
E103	145	PU display language selection	87
E104	990	PU buzzer control	87
E105	991	PU contrast adjustment	88
E200	161	Frequency setting / key lock operation selection	88
E202	40	RUN key rotation direction selection	88
E300	30	Regenerative function selection	159
E400	77	Parameter write selection	89
E410	296	Password lock level	90
E411	297	Password lock/unlock	90
E415	520	Parameter for manufacturer setting. Do not set.	
E600	72	PWM frequency selection	92
E601	240	Soft-PWM operation selection	92

◆ F: Parameters for the settings of the acceleration/deceleration time and the acceleration/deceleration pattern

Parameters for the motor acceleration/deceleration characteristics.

Pr. group	Pr.	Name	Refer to page
F000	20	Acceleration/deceleration reference frequency	93
F002	16	Jog acceleration/deceleration time	108
F003	611	Acceleration time at a restart	159
F010	7	Acceleration time	93
F011	8	Deceleration time	93
F020	44	Second acceleration/deceleration time	93
F021	45	Second deceleration time	93
F100	29	Acceleration/deceleration pattern selection	95
F101	59	Remote function selection	96
F102	13	Starting frequency	99

◆ D: Parameters for the setting of operation command and frequency command

Parameters for setting the command source to the inverter, and the motor driving frequency and torque.

Pr. group	Pr.	Name	Refer to page
D000	79	Operation mode selection	100, 104
D001	340	Communication startup mode selection	104
D010	338	Communication operation command source	105
D011	339	Communication speed command source	105
D013	551	PU mode operation command source selection	105
D020	78	Reverse rotation prevention selection	108
D200	15	Jog frequency	108
D301	4	Multi-speed setting (high speed)	109
D302	5	Multi-speed setting (middle speed)	109
D303	6	Multi-speed setting (low speed)	109
D304 to D307	24 to 27	Multi-speed setting (speed 4 to speed 7)	109
D308 to D315	232 to 239	Multi-speed setting (speed 8 to speed 15)	109

◆ H: Protective function parameter

Parameters to protect the motor and the inverter.

Pr. group	Pr.	Name	Refer to page
H000	9	Electronic thermal O/L relay	112, 147
H101	249	Earth (ground) fault detection at start	114
H104	631	Inverter output fault detection enable/disable selection	114
H105	598	Undervoltage detection enable/disable selection	115
H200	251	Output phase loss protection selection	115
H201	872	Input phase loss protection selection	115
H300	65	Retry selection	115
H301	67	Number of retries at fault occurrence	115
H302	68	Retry waiting time	115
H303	69	Retry count display erase	115
H400	1	Maximum frequency	117
H401	2	Minimum frequency	117
H402	18	High speed maximum frequency	117
H420	31	Frequency jump 1A	118
H421	32	Frequency jump 1B	118

Pr. group	Pr.	Name	Refer to page
H422	33	Frequency jump 2A	118
H423	34	Frequency jump 2B	118
H424	35	Frequency jump 3A	118
H425	36	Frequency jump 3B	118
H500	22	Stall prevention operation level	119
H501	156	Stall prevention operation selection	119
H610	23	Stall prevention operation level compensation factor at double speed	119
H611	66	Stall prevention operation reduction starting frequency	119

◆ M: Monitoring and its output signal

Parameters for the settings regarding the monitoring to check the inverter's operating status and the output signals for the monitoring.

Pr. group	Pr.	Name	Refer to page
M020	170	Watt-hour meter clear	124
M030	171	Operation hour meter clear	124
M101	774	Operation panel monitor selection 1	124
M102	775	Operation panel monitor selection 2	124
M103	776	Operation panel monitor selection 3	124
M400	190	NET Y0 terminal function selection	126
M401	191	NET Y1 terminal function selection	126
M402	192	NET Y2 terminal function selection	126
M403	193	NET Y3 terminal function selection	126
M404	194	NET Y4 terminal function selection	126
M405	195	ABC terminal function selection	126
M430	157	OL signal output timer	119
M441	41	Up-to-frequency sensitivity	129
M442	42	Output frequency detection	129
M443	43	Output frequency detection for reverse rotation	129
M460	150	Output current detection level	129
M461	151	Output current detection signal delay time	129
M464	167	Output current detection operation selection	129

◆ T: Multi-function input terminal parameters

Parameters for the setting of the input terminals via which commands are given to the inverter.

Pr. group	Pr.	Name	Refer to page
T000	73	Analog input selection	131
T001	267	Terminal 4 input selection	131
T002	74	Input filter time constant	134
T022	125	Terminal 2 frequency setting gain frequency	134
T042	126	Terminal 4 frequency setting gain frequency	134
T054	778	4 mA input check filter	139
T200	C2 (902)*1	Terminal 2 frequency setting bias frequency	134
T201	C3 (902)*1	Terminal 2 frequency setting bias	134
T202	125 (903)*1	Terminal 2 frequency setting gain frequency	134
T203	C4 (903)*1	Terminal 2 frequency setting gain	134
T400	C5 (904)*1	Terminal 4 frequency setting bias frequency	134
T401	C6 (904)*1	Terminal 4 frequency setting bias	134
T402	126 (905)*1	Terminal 4 frequency setting gain frequency	134
T403	C7 (905)*1	Terminal 4 frequency setting gain	134
T700	178	STF terminal function selection	142
T701	179	STR terminal function selection	142
T702	180	RL terminal function selection	142
T703	181	RM terminal function selection	142
T704	182	RH terminal function selection	142
T720	17	MRS input selection	143

◆ C: Motor constant parameters

Parameters for the applied motor setting.

Pr. group	Pr.	Name	Refer to page
C100	71	Applied motor	147, 147
C101	80	Motor capacity	147
C110	96	Auto tuning setting/status	147
C120	90	Motor constant (R1)	147
C125	82	Motor excitation current	147

◆ A: Application parameters

Parameters for the setting of a specific application.

Pr. group	Pr.	Name	Refer to page
A300	592	Traverse function selection	151
A301	593	Maximum amplitude amount	151

Pr. group	Pr.	Name	Refer to page
A302	594	Amplitude compensation amount during deceleration	151
A303	595	Amplitude compensation amount during acceleration	151
A304	596	Amplitude acceleration time	151
A305	597	Amplitude deceleration time	151
A601	131	PID upper limit	152
A602	132	PID lower limit	152
A610	128	PID action selection	152
A611	133	PID action set point	152
A612	127	PID control automatic switchover frequency	152
A613	129	PID proportional band	152
A614	130	PID integral time	152
A615	134	PID differential time	152
A621	575	Output interruption detection time	152
A622	576	Output interruption detection level	152
A623	577	Output interruption cancel level	152
A680	573	4 mA input check selection	139
A702	57	Restart coasting time	159
A703	58	Restart cushion time	159
A710	165	Stall prevention operation level for restart	159
A730	261	Power failure stop selection	160

◆ N: Communication operation parameters

Parameters for the setting of communication operation such as the communication specifications or operating characteristics.

Pr. group	Pr.	Name	Refer to page
N000	549	Protocol selection	165
N001	342	Communication EEPROM write selection	165
N013	502	Stop mode selection at communication error	165
N020	117	PU communication station number	168
N021	118	PU communication speed	168
N022	119	PU communication data length	168
N023	119	PU communication stop bit length	168
N024	120	PU communication parity check	168
N025	121	PU communication retry count	168
N026	122	PU communication check time interval	168
N027	123	PU communication waiting time setting	168

Pr. group	Pr.	Name	Refer to page
N028	124	PU communication CR/LF selection	168
N080	343	Communication error count	182

◆ G: Control parameters

Parameters for motor control.

Pr. group	Pr.	Name	Refer to page
G000	0	Torque boost	193
G001	3	Base frequency	194
G002	19	Base frequency voltage	194
G030	60	Energy saving control selection	195
G040	100	V/F1 (first frequency)	195
G041	101	V/F1 (first frequency voltage)	195
G042	102	V/F2 (second frequency)	195
G043	103	V/F2 (second frequency voltage)	195
G044	104	V/F3 (third frequency)	195
G045	105	V/F3 (third frequency voltage)	195
G100	10	DC injection brake operation frequency	197
G101	11	DC injection brake operation time	197
G106	250	Stop selection	198
G110	12	DC injection brake operation voltage	197
G120	882	Regeneration avoidance operation selection	199
G121	883	Regeneration avoidance operation level	199
G123	885	Regeneration avoidance compensation frequency limit value	199
G124	886	Regeneration avoidance voltage gain	199
G125	665	Regeneration avoidance frequency gain	199
G130	660	Increased magnetic excitation deceleration operation selection	200
G131	661	Excitation increase rate	200
G132	662	Increased magnetic excitation current level	200
G203	245	Rated slip	202
G204	246	Slip compensation time constant	202
G205	247	Constant-power range slip compensation selection	202

*1 The parameter number in parentheses is the one used (displayed) on the LCD operation panel and the parameter unit.

5.2 Control method

V/F control (initial setting) and General-purpose magnetic flux vector control are available with this inverter.

◆ V/F control

The inverter controls the output frequency (F) and the output voltage (V) so that the ratio of frequency to voltage (V/F) is kept constant when the frequency is changed.

◆ General-purpose magnetic flux vector control

The inverter under this control method compensates for the output voltage to provide a motor with the current which meets the load torque. This control mechanism results in the improvement of the motor torque at low speeds. The output frequency is also compensated (slip compensation is performed) by setting parameters for slip compensation (**Pr.245 to Pr.247**) to bring the actual motor speed closer to the commanded speed. This control method is useful when the load fluctuates are severe.

NOTE

- General-purpose magnetic flux vector control requires the following conditions.
If the conditions are not satisfied, select V/F control. Otherwise, malfunctions such as insufficient torque, uneven rotation may occur.
 - The rated motor current should be equal to or less than the inverter rated current. (It must be 0.4 kW or higher.)
If a motor with substantially low rated current compared with the inverter rated current, however, is used, speed and torque accuracies may deteriorate due to torque ripples, etc. As a reference, select the motor with the rated motor current that is 40% or higher of the inverter rated current.
 - Set **Pr.82** and **Pr.90** properly according to the motor to be used.
Single-motor operation (one motor to one inverter) is performed.
 - The wiring length from inverter to motor is 30 m or less. (When the wiring length exceeds 30 m, perform offline auto tuning with the wiring in place.)
-

5.3 (E) Environment setting parameters

Purpose	Parameter to set			Refer to page
To set a limit for the reset function. To shut off output if the operation panel disconnects. To force deceleration to a stop on the operation panel.	Reset selection / Disconnected PU detection / PU Stop selection	P.E100 to P.E102	Pr.75	85
To select the display language of the parameter unit	PU display language selection	P.E103	Pr.145	87
To control the buzzer (beep) of the parameter unit or LCD operation panel	PU buzzer control	P.E104	Pr.990	87
To adjust the LCD contrast of the parameter unit	PU contrast adjustment	P.E105	Pr.991	88
To select the command for the direction of rotation to be assigned to the RUN key on the operation panel	RUN key rotation direction selection	P.E202	Pr.40	88
To set the frequency using the UP/DOWN key on the operation panel. To disable the operation panel.	Operation panel operation selection	P.E200	Pr.161	88
To prevent parameter rewriting	Parameter write disable selection	P.E400	Pr.77	89
To restrict access to parameters with a password	Password	P.E410, P.E411	Pr.296, Pr.297	90
To reduce the motor noise and EMI	PWM carrier frequency changing	P.E600, P.E601	Pr.72, Pr.240	92



5

5.3.1 Reset selection / Disconnected PU detection / PU stop selection

The acceptance of reset command, the inverter operation in the event of detection of the PU (operation panel / parameter unit) disconnected, and the acceptance of stop command from the PU (PU stop function) can be selected.

Pr.	Name	Initial value	Setting range	Description
75	Reset selection / Disconnected PU detection / PU stop selection	14	0 to 3, 14 to 17	In the initial setting, the reset command can always be input, the operation continues when the PU is disconnected, and the PU stop function is enabled in any operation mode.
E100	Reset selection	0	0	The reset command can always be input.
			1	The reset command can be input only when the protective function is activated.
E101	Disconnected PU detection	0	0	Operation continues even when the PU is disconnected.
			1	The inverter output is shut off when the PU is disconnected.
E102	PU stop selection	0	0	Only in PU operation mode, the inverter decelerates to a stop by pressing the STOP key on the PU.
			1	The inverter decelerates to a stop by pressing the STOP key on the PU in any operation mode of the PU, External, or Network.

The parameters above do not return to their initial values even if Parameter clear or All parameter clear is executed.

Pr.75 setting	Reset selection	Disconnected PU detection	PU stop selection
0	The reset command can always be input.	Operation continues even when PU is disconnected.	The inverter decelerates to a stop only when  is pressed in the PU operation mode.
1	The reset command can be input only when the protective function is activated.		
2	The reset command can always be input.	Inverter output shut off when PU is disconnected.	The inverter decelerates to a stop when  is pressed in any operation mode of the PU, External, or Network.
3	The reset command can be input only when the protective function is activated.		
14 (initial value)	The reset command can always be input.	Operation continues even when PU is disconnected.	
15	The reset command can be input only when the protective function is activated.		
16	The reset command can always be input.	Inverter output shut off when PU is disconnected.	
17	The reset command can be input only when the protective function is activated.		

◆ Reset selection (P.E100)

- When Pr.75 = "1, 3, 15, or 17", the reset command can be input (by turning ON the RES signal or via communication) only when the protective function is activated.

NOTE

- When the RES signal is input during operation, the motor coasts since the inverter being reset shuts off the output. Also, the cumulative values of electronic thermal O/L relay and regenerative brake duty are cleared.
- The reset command by pressing the Reset key on PU can be input only when the protective function is activated, regardless of the Pr.75 setting.



◆ Disconnected PU detection (P.E101)

- If the inverter detects that the enclosure surface operation panel (FR-PA07) / LCD operation panel (FR-LU08) / parameter unit (FR-PU07) is disconnected from the inverter for 1 second or longer while Pr.75 = "2, 3, 16, or 17", the indication "E.PUE" (PU disconnection fault) is displayed and the inverter output is shut off.

NOTE

- When the FR-PA07/LU08/PU07 has been disconnected since before power-ON, the output is not shut off.
- To restart the inverter, confirm that the FR-PA07/LU08/PU07 is connected before reset.
- If the FR-PA07/LU08/PU07 is disconnected during PU JOG operation while Pr.75 = "0, 1, 14, or 15" (operation continues even when the PU is disconnected), the inverter decelerates to a stop.
- During RS-485 communication operation via the PU connector, the setting for the reset selection and the PU stop selection is enabled, but the setting for the disconnected PU detection is disabled. (The communication is checked according to the setting of Pr.122 PU communication check time interval.)



◆ PU stop selection (P.E102)

- The PU stop function (deceleration stop of the inverter by pressing  on the PU) is enabled in any operation mode of PU, External, or Network when Pr.75 = "14 to 17".
- When the inverter is stopped by using the PU stop function, the indication " " is displayed on the PU. A fault output is not provided.
- When Pr.75 = "0 to 3", deceleration stop of the inverter by pressing  is enabled only in the PU operation mode.

NOTE

- When  on the operation panel is pressed in the PU operation mode while **Pr.551 PU mode operation command source selection** = "9999 (initial value)" and the FR-PA07/LU08/PU07 is connected to the PU connector on the inverter, the inverter is stopped and the indication "PS" is displayed on the operation panel.

◆ How to restart the inverter which stopped with the push of  on the PU in the External operation mode (How to reset the PU stop (PS) fault)

- To reset the PU stop fault using the operation panel
 1. After completion of deceleration to a stop, switch OFF the STF or STR signal.
 2. Press . "PS" is cleared.
(when **Pr.79 Operation mode selection** = "2 or 3")
- To reset the PU stop fault using the FR-PU07/PA07/LU08
 1. After completion of deceleration to a stop, switch OFF the STF or STR signal.
 2. Press . "PS" is cleared.

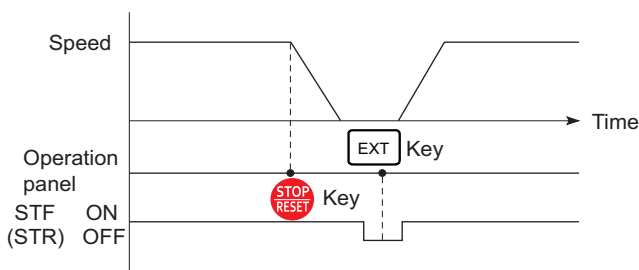

- The inverter can be restarted by resetting the power supply or resetting with the RES signal.

NOTE

- Even when **Pr.250 Stop selection** ≠ "9999" and coasting stop is selected, the PU stop function executed in the External operation mode does not provide coasting stop but deceleration stop.

5.3.2 PU display language selection

You can switch the display language of the parameter unit (FR-PU07) to another.

Pr.	Name	Initial value	Setting range	Description
145 E103	PU display language selection	1	0	Japanese
			1	English
			2	German
			3	French
			4	Spanish
			5	Italian
			6	Swedish
			7	Finnish

5.3.3 Beep control

The key operation beep (buzzer) of the LCD operation panel (FR-LU08) or parameter unit can be turned ON/OFF.

Pr.	Name	Initial value	Setting range	Description
990 E104	PU buzzer control	1	0	Beep (buzzer) is OFF.
			1	Beep (buzzer) is ON.

NOTE

- When with buzzer is set, the buzzer sounds if an inverter fault occurs.

5.3.4 PU contrast adjustment

Contrast adjustment of the LCD of the LCD operation panel (FR-LU08) and the parameter unit (FR-PU07) can be performed. Decreasing the setting value lowers the contrast.

Pr.	Name	Initial value	Setting range	Description
991 E105	PU contrast adjustment	58	0 to 63	0: Lowest → 63: Highest

The above parameter is displayed as a simple mode parameter only when the LCD operation panel (FR-LU08) and the parameter unit (FR-PU07) is connected.

5.3.5 RUN key rotation direction selection

This parameter is used to determine which direction the motor rotates when the RUN key on the operation panel is pressed.

Pr.	Name	Initial value	Setting range	Description
40 E202	RUN key rotation direction selection	0	0	Forward
			1	Reverse

5.3.6 Frequency easy setting function selection/ key lock function selection

The frequency setting value can be easily changed by simply pressing Δ or ∇ on the operation panel.

The key operation of the operation panel can be disabled.

Pr.	Name	Initial value	Setting range	Description
161 E200	Frequency setting / key lock operation selection	0	0	Frequency easy setting function disabled. Key lock function disabled.
			1	Frequency easy setting function enabled. Key lock function disabled.
			10	Frequency easy setting function disabled. Key lock function enabled.
			11	Frequency easy setting function enabled. Key lock function enabled.

◆ Setting the frequency by pressing Δ or ∇

- The frequency can be easily set by simply pressing Δ or ∇ on the operation panel during operation. SET needs not to be pressed to enter the setting. (To check the usual setting method, refer to [page 69](#).)

NOTE

- If the display changes from blinking "50.00" to "0.00", the setting value of **Pr.161** may not be "1".
- The newly-set frequency is saved as the set frequency in EEPROM in 10 seconds after the setting is completed.
- When the frequency is set by pressing Δ or ∇ , the output frequency goes up to the setting value of **Pr.1 Maximum frequency**. Be aware of which value is set in **Pr.1**, and adjust the **Pr.1** setting according to the application.

◆ Disabling keys on the operation panel (by holding down the MODE key for 2 seconds)

- Keys on the operation panel can be disabled to prevent parameter changes, unexpected starts, or frequency changes.
- Set **Pr.161** to "10 or 11" and then press MODE for 2 seconds to disable the keys (the key lock function is set to be enabled).

- When the keys become disabled, "Hold" appears on the operation panel for a moment. If the key operation is attempted while the keys are disabled, "Hold" appears. (After no key operation for 2 seconds, the display returns to the monitoring screen.)
- To enable the keys again, press  for 2 seconds.

NOTE

- Even while the keys are disabled, the monitoring and  are enabled.
- The PU stop warning cannot be reset by using keys while the key lock function is enabled.

« Parameters referred to »

Pr.1 Maximum frequency  page 117

5.3.7 Parameter write selection

Whether to enable the parameter write or not can be selected. Use this function to prevent parameter values from being rewritten by misoperation.

Pr.	Name	Initial value	Setting range	Description
77 E400	Parameter write selection	0	0	Parameter write is enabled only during stop.
			1	Parameter write is disabled.
			2	Parameter write is enabled in any operation mode regardless of the operation status.

- Pr.77 can be set at any time regardless of the operation mode or operation status. (Setting through communication is unavailable.)

◆ Parameter write enabled only during stop (Pr.77 = "0 (initial value)")

- Parameters can be written only during a stop in the PU operation mode.
- The following parameters can always be written regardless of the operation mode or operation status.

Pr.	Name
4 to 6	(Multi-speed setting high-speed, middle-speed, low-speed)
22	Stall prevention operation level
24 to 27	(Multi-speed setting speed 4 to speed 7)
72 ^{*1}	PWM frequency selection
75	Reset selection / Disconnected PU detection / PU stop selection
77	Parameter write selection
79 ^{*2}	Operation mode selection
129	PID proportional band
130	PID integral time
133	PID action set point

Pr.	Name
134	PID differential time
232 to 239	(Multi-speed setting speed 8 to speed 15)
240 ^{*1}	Soft-PWM operation selection
296, 297	(Password setting)
340 ^{*2}	Communication startup mode selection
551 ^{*2}	PU mode operation command source selection
774 to 776	(Operation panel monitor item selection)
990	PU buzzer control
991	PU contrast adjustment

*1 Writing during operation is enabled in PU operation mode, but disabled in External operation mode.

*2 Writing during operation is disabled. To change the parameter setting, stop the operation.

◆ Parameter write disabled (Pr.77 = "1")

- Parameter write, Parameter clear, and All parameter clear are disabled. (Parameter read is enabled.)
- The following parameters can be written even if Pr.77 = "1".

Pr.	Name
22	Stall prevention operation level
75	Reset selection / Disconnected PU detection / PU stop selection
77	Parameter write selection

Pr.	Name
79 ^{*1}	Operation mode selection
296	Password lock level
297	Password lock/unlock

*1 Writing during operation is disabled. To change the parameter setting, stop the operation.

◆ Parameter write enabled even during operation (Pr.77 = "2")

- Parameters can always be written.
- The following parameters cannot be written during operation even if Pr.77 = "2". To change the parameter setting, stop the operation.

Pr.	Name
23	Stall prevention operation level compensation factor at double speed
60	Energy saving control selection
66	Stall prevention operation reduction starting frequency
71	Applied motor
79	Operation mode selection
80	Motor capacity
82	Motor excitation current

Pr.	Name
90	(Motor constant)
96	Auto tuning setting/status
178 to 182	(Input terminal function selection)
195	(Output terminal function selection)
261	Power failure stop selection
598	Undervoltage detection enable/disable selection
660 to 662	(Increased magnetic excitation deceleration)

5.3.8 Password

Setting a 4-digit password can restrict access to parameters (reading/writing).

Pr.	Name	Initial value	Setting range	Description
296 E410	Password lock level	9999	1 to 6, 101 to 106	Password protection enabled. Setting the access (reading/writing) restriction level to parameters locked with a password enables writing to Pr.297.
			9999	Password protection disabled. (Writing to Pr.297 is disabled.)
297 E411	Password lock/unlock	9999	1000 to 9998	Input a 4-digit password to lock parameters, or input the valid password to unlock the locked parameters.
			(0 to 5) ^{*1}	(Read only after the parameters are locked.) The number of failed password attempts is displayed when Pr.296 = "101 to 106". The readout is fixed to "0" when Pr.296 = "1 to 6".
			(9999) ^{*1}	"9999" is displayed when the password protection is enabled (Pr.296 ≠ "9999") but parameters are unlocked, or when the password protection function is disabled (Pr.296 = "9999").

*1 Although "0 or 9999" can be input in Pr.297 from the PU other than the operation panel, the value is invalid. (The display cannot be changed.)

◆ Parameter reading/writing restriction level (Pr.296)

- The access (reading/writing) restriction level to parameters in the PU operation mode or NET operation mode can be selected with Pr.296.

Pr.296 setting	Access to parameters in the PU operation mode ^{*2}		Access to parameters in the NET operation mode ^{*3}	
	Read	Write ^{*1}	Read	Write ^{*1}
9999	○	○	○	○
1, 101	○	×	○	×
2, 102	○	×	○	○
3, 103	○	○	○	×
4, 104	×	×	×	×
5, 105	×	×	○	○
6, 106	○	○	×	×

○: Enabled, ×: Disabled

*1 The parameters affected by the setting of Pr.77 Parameter write selection are not allowed to be written even in the case where "○" is shown.

*2 Access to parameters from the command source in the PU operation mode (the PU in the initial setting). (For the PU operation mode command source selection, refer to page 105.)

*3 Access to parameters from the command source in the NET operation mode. (For the NET operation mode command source selection, refer to page 105.)

◆ Locking parameters with a password (Pr.296, Pr.297)

- The procedure of locking parameters with a password is as follows.

1. Set the parameter reading/writing restriction level to enable the password protection. (Set a value other than "9999" in **Pr.296**.)

Pr.296 setting	Allowable number of failed password attempts	Pr.297 readout
1 to 6	Unlimited	Always 0
101 to 106 ^{*1}	Limited to 5 times	Number of failed password attempts (0 to 5)

*1 If an invalid password is input 5 times while any of "101 to 106" is set in **Pr.296**, the password is locked up afterward (the locked parameters cannot be unlocked even with the valid password). All parameter clear is required to reset the password. (In this case, the parameters are returned to their initial values.)

2. Write a four-digit number (1000 to 9998) to **Pr.297** as a password (writing is disabled when Pr.296 = "9999"). After a password is set, parameters are locked and access (reading/writing) to the parameters is limited at the level set in Pr.296 until the valid password is input to unlock the locked parameters.

NOTE

- After a password is set, the **Pr.297** readout is always any of "0 to 5".
- "LoCd" appears when a password-protected parameter is attempted to be read/written.
- Even if a password is set, the parameters which are written by the inverter, such as parameters related to the life check of inverter parts, are overwritten as needed.
- Even if a password is set, **Pr.991 PU contrast adjustment** can be read/written when the parameter unit (FR-PU07) is connected.

◆ Unlocking the locked parameters (Pr.296, Pr.297)

- There are two ways to unlock the locked parameters.
- Enter the password in Pr.297. When a valid password is input, the locked parameters can be unlocked. When an invalid password is input, an error indication appears and the parameters cannot be unlocked. If an invalid password is input 5 times while any of "101 to 106" is set in Pr.296, the locked parameters cannot be unlocked afterward even with the valid password (the password is locked up).
- Perform All parameter clear.

NOTE

- If the password is forgotten, it can be reset by performing All parameter clear, but the other parameters are also reset.
- All parameter clear cannot be performed during the inverter operation.
- When using FR Configurator2 in the PU operation mode, do not set "4, 5, 104, or 105" (parameter read is disabled) in **Pr.296**. The inverter operation using FR Configurator2 may not correctly performed.
- The means to reset the password varies according to how the reset command is sent (from the PU or through RS-485 communication).

	PU	RS-485 communication
All parameter clear	○	○
Parameter clear	×	×

- : Password reset enabled, ×: Password reset disabled
- For the information how to perform Parameter clear or All parameter clear with the parameter unit, refer to the Instruction Manual of the parameter unit. (For the operation panel, refer to [page 203](#). For RS-485 communication using the Mitsubishi inverter protocol, refer to [page 169](#).)

◆ Access to parameters according to the password status

Parameter	Password protection disabled / Parameters unlocked		Parameters locked	Password locked up
	Pr.296 = 9999 Pr.297 = 9999 (read only)	Pr.296 ≠ 9999 Pr.297 = 9999 (read only)	Pr.296 ≠ 9999 Pr.297 = any of 0 to 4 (read only)	Pr.296 = any of 101 to 106 Pr.297 = 5 (read only)
Pr.296	Read	○	○	○
	Write	○	×	×
Pr.297	Read	○	○	○
	Write	×	○	○ ^{*2}
Pr.CLR Parameter clear (Write)	○	○	×	×
ALL.C All parameter clear (Write)	○	○	○ ^{*1}	○ ^{*1}
Pr.CPY Parameter copy (Write)	○	○	×	×

○: Enabled, ×: Disabled

*1 All parameter clear cannot be performed during the inverter operation.

*2 Inputting a password is possible but the locked-up password cannot be unlocked or reset even with the valid password.

NOTE

- When "4, 5, 104, or 105" is set in **Pr.296** and a password is set, **Pr.15 JOG frequency** is not listed on the parameter unit (FR-PU07).
- When a password has been set and parameters are locked, Parameter copy cannot be performed using the operation panel or parameter unit.

Parameters referred to

Pr.77 Parameter write selection [page 89](#)

Pr.551 PU mode operation command source selection [page 105](#)

5.3.9 PWM carrier frequency and Soft-PWM control

The motor sound can be changed.

Pr.	Name	Initial value	Setting range	Description
72 E600	PWM frequency selection	2	2 to 12	The PWM carrier frequency can be changed. The setting value represents the frequency in kHz.
240 E601	Soft-PWM operation selection	1	0	Soft-PWM control disabled.
			1	Soft-PWM control enabled.
			10	Soft-PWM control disabled (Soft-PWM control in the low-speed range enabled).
			11	Soft-PWM control enabled (Soft-PWM control in the low-speed range enabled).

◆ Changing the PWM carrier frequency (Pr.72)

- The PWM carrier frequency of the inverter can be changed.
- Changing the PWM carrier frequency can be effective for avoiding the resonance frequency of the mechanical system or motor, as a countermeasure against EMI generated from the inverter, or for reducing leakage current caused by PWM switching.

◆ Soft-PWM control (Pr.240)

- Soft-PWM control is a function that changes the motor noise from a metallic sound into an inoffensive, complex tone.
- Setting **Pr.240** = "1 or 11" enables the Soft-PWM control.
- Setting **Pr.240** "10 or 11" enables the Soft-PWM control in the low-speed range.
- To enable the Soft-PWM control, set **Pr.72** to 5 kHz or less.

5.4 (F) Setting of acceleration/deceleration time and acceleration/deceleration pattern

Purpose	Parameter to set			Refer to page
To set the motor acceleration/deceleration time	Acceleration/deceleration time	P.F000, P.F002, P.F003, P.F010, P.F011, P.F020, P.F021	Pr.7, Pr.8, Pr.16, Pr.20, Pr.44, Pr.45, Pr.611	93
To set the acceleration/deceleration pattern suitable for an application	Acceleration/deceleration pattern	P.F100	Pr.29	95
To command smooth speed transition with terminals	Remote setting function	P.F101	Pr.59	96
To set the starting frequency	Starting frequency	P.F102	Pr.13	99

5.4.1 Setting the acceleration and deceleration time

The following parameters are used to set motor acceleration/deceleration time.

Set a larger value for a slower acceleration/deceleration, and a smaller value for a faster acceleration/deceleration.

For the acceleration time at automatic restart after instantaneous power failure, refer to **Pr.611 Acceleration time at a restart** (page 159).

Pr.	Name	Initial value	Setting range	Description
20 F000	Acceleration/deceleration reference frequency	50 Hz	1 to 400 Hz	Set the frequency that is the basis of acceleration/deceleration time. As acceleration/deceleration time, set the frequency change time from a stop status to Pr.20 .
16 F002	Jog acceleration/deceleration time	0.5 s	0 to 3600 s	Set the acceleration/deceleration time for JOG operation (from stop status to Pr.20). Refer to page 108 .
611 F003	Acceleration time at a restart	9999	0 to 3600 s, 9999	Set the acceleration time for restart (from stop status to Pr.20). When "9999" is set, standard acceleration time (for example, Pr.7) is applied as the acceleration time at restart. Refer to page 159 .
7 F010	Acceleration time	5 s ^{*1}	0 to 3600 s	Set the motor acceleration time (from stop status to Pr.20).
		10 s ^{*2}		
		15 s ^{*3}		
8 F011	Deceleration time	5 s ^{*1}	0 to 3600 s	Set the motor deceleration time (from Pr.20 to stop status).
		10 s ^{*2}		
		15 s ^{*3}		
44 F020	Second acceleration/deceleration time	5 s	0 to 3600 s	Set the acceleration/deceleration time when the RT signal is ON.
		10 s ^{*2}		
		15 s ^{*3}		
45 F021	Second deceleration time	9999	0 to 3600 s	Set the deceleration time when the RT signal is ON.
			9999	Pr.20 Second acceleration/deceleration time

*1 The Initial value for the FR-CS84-080 or lower and FR-CS82S-100 or lower.

*2 The Initial value for the FR-CS84-120 and FR-CS84-160.

*3 The Initial value for the FR-CS84-230 or higher.

◆ Acceleration time setting (Pr.7, Pr.20)

- Use **Pr.7 Acceleration time** to set the acceleration time required to reach **Pr.20 Acceleration/deceleration reference frequency** from stop status.
- Set the acceleration time according to the following formula.

Acceleration time setting = $\text{Pr.20} \times \text{Acceleration time from stop status to maximum frequency} / (\text{maximum frequency} - \text{Pr.13})$

- For example, the following calculation is performed to find the setting value for **Pr.7** when increasing the output frequency to the maximum frequency of 40 Hz in 10 s with **Pr.20** = 50 Hz (initial value) and **Pr.13** = 0.5 Hz.

$$\text{Pr.7} = 50 \text{ Hz} \times 10 \text{ s} / (40 \text{ Hz} - 0.5 \text{ Hz}) \approx 12.1 \text{ s}$$

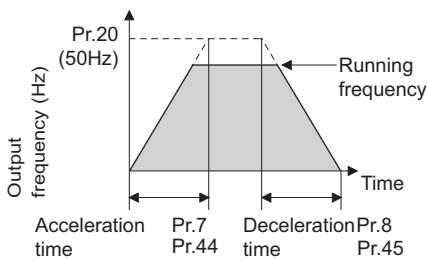

◆ Deceleration time setting (Pr.8, Pr.20)

- Use **Pr.8 Deceleration time** to set the deceleration time required to reach stop status from **Pr.20 Acceleration/deceleration reference frequency**.
- Set the deceleration time according to the following formula.

Deceleration time setting = $\text{Pr.20} \times \text{deceleration time from maximum frequency to stop} / (\text{maximum frequency} - \text{Pr.10})$

- For example, the following calculation is used to find the setting value for **Pr.8** when decreasing the output frequency from the maximum frequency of 50 Hz in 10 s with **Pr.20** = 120 Hz and **Pr.10** = 3 Hz.

$$\text{Pr.8} = 120 \text{ Hz} \times 10 \text{ s} / (50 \text{ Hz} - 3 \text{ Hz}) \approx 25.5 \text{ s}$$

NOTE

- If the acceleration/deceleration time is set, the actual motor acceleration/deceleration time cannot be made shorter than the shortest acceleration/deceleration time determined by the mechanical system J (moment of inertia) and motor torque.
- If the **Pr.20** setting is changed, the **Pr.125 and Pr.126 (frequency setting signal gain frequency)** settings do not change. Set **Pr.125 and Pr.126** to adjust the gains.

◆ Setting multiple acceleration/deceleration times (RT signal, Pr.44, Pr.45)

- **Pr.44 and Pr.45** are valid when the RT signal is ON.
- When "9999" is set in **Pr.45**, the deceleration time becomes equal to the acceleration time (**Pr.44**).

NOTE

- The reference frequency during acceleration/deceleration depends on the setting of **Pr.29 Acceleration/deceleration pattern**. (Refer to [page 95](#).)
- The RT signal can be assigned to an input terminal by setting **Pr.178 to Pr.182 (Input terminal function selection)**. Changing the terminal assignment may affect other functions. Set parameters after confirming the function of each terminal.
- Set "3" in any of **Pr.178 to Pr.182 (Input terminal function selection)** to assign the RT signal to another terminal.

5.4.2 Acceleration/deceleration pattern

The acceleration/deceleration pattern can be set according to the application.

Pr.	Name	Initial value	Setting range	Description
29 F100	Acceleration/deceleration pattern selection	0	0	Linear acceleration/deceleration
			2	S-pattern acceleration/deceleration B

◆ Linear acceleration/deceleration (Pr.29 = "0" initial value)

- When the frequency is changed for acceleration, deceleration, etc. during inverter operation, the output frequency is changed linearly (linear acceleration/deceleration) to reach the set frequency without straining the motor and inverter. Linear acceleration/deceleration has a uniform frequency/time slope.

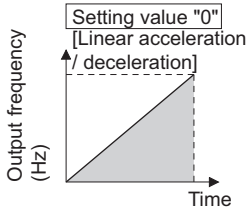

◆ S-pattern acceleration/deceleration B (Pr.29 = "2")

- This is useful for preventing collapsing stacks such as on a conveyor. S-pattern acceleration/deceleration B can reduce the impact during acceleration/deceleration by accelerating/decelerating while maintaining an S-pattern from the present frequency (f2) to the target frequency (f1).

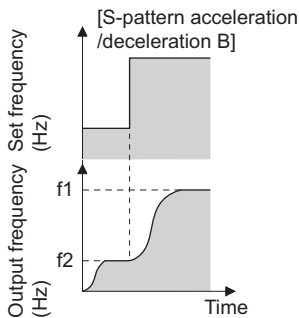

NOTE

- When the RT signal turns ON during acceleration or deceleration with the S-pattern acceleration/deceleration B enabled, a pattern of acceleration or deceleration changes to linear at the moment.

5.4.3 Remote setting function

Even if the operation panel is located away from the enclosure, contact signals can be used to perform continuous variable-speed operation, without using analog signals.

Pr.	Name	Initial value	Setting range	Description		
				RH, RM, RL signal function	Frequency setting storage	Deceleration to the frequency lower than the set frequency
59 F101	Remote function selection	0	0	Multi-speed setting	—	Not available
			1	Remote setting	Displayed	
			2	Remote setting	Not used	
			3	Remote setting	Not used (Turning STF/STR OFF clears remotely-set frequency.)	

◆ Remote setting function

- Use **Pr.59** to enable/disable the remote setting function and enable/disable the frequency setting storage function during remote setting.
- When **Pr.59** ≠ "0" (remote setting function valid), the functions of the RH, RM and RL signals are changed to acceleration (RH), deceleration (RM) and clear (RL).

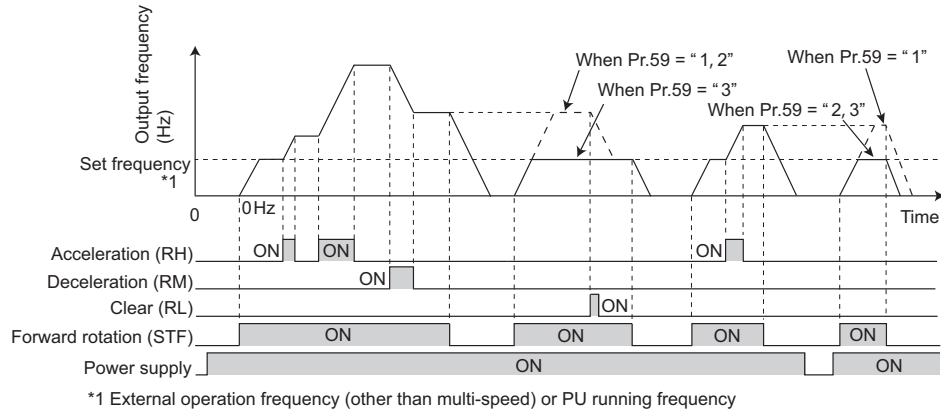
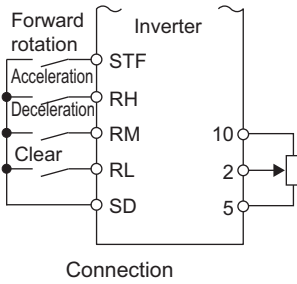

◆ Acceleration/deceleration operation

- When the acceleration (RH) signal is turned ON, the set frequency increases. The increased speed at this time is determined by the setting of **Pr.44 Second acceleration/deceleration time**. Turning OFF the RH signal stops increasing the set frequency and run the motor at the frequency at that time.
- When the deceleration (RM) signal is turned ON, the set frequency decreases. The decreased speed at this time is determined by the setting of **Pr.45 Second acceleration/deceleration time**. When **Pr.45** = "9999", the deceleration speed is the same as **Pr.44** setting. Turning OFF the RM signal stops decreasing the set frequency and runs the motor at the frequency at that time.

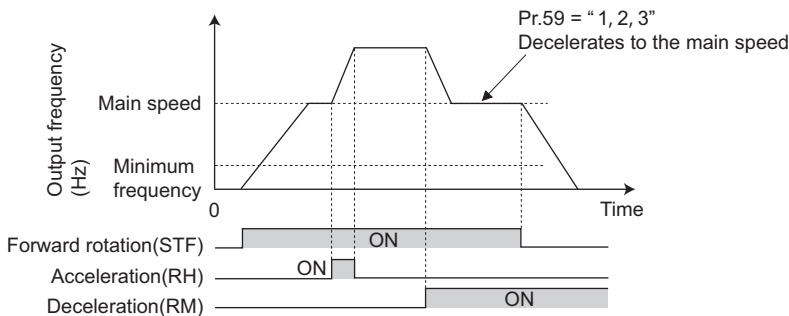

NOTE

- While the RT signal is OFF, **Pr.44 Second acceleration/deceleration time** and **Pr.45 Second deceleration time** are used as the set frequency accelerating/decelerating time at turn ON of the acceleration/deceleration signal. If the **Pr.7** and **Pr.8** settings are longer, the acceleration/deceleration time set by **Pr.7** and **Pr.8** are applied. While the RT signal is ON, **Pr.44** and **Pr.45** settings are used as the acceleration/deceleration time regardless of the **Pr.7** and **Pr.8** settings.

◆ Output frequency

- During External operation, the remotely-set frequency set with RH and RM signals is added to the terminal 4 input and External operation mode frequency (PU operation mode frequency when **Pr.79** = "3" (External and PU combined operation)) except multi-speed setting.
- During PU operation, the remotely-set frequency set with RH and RM signal operation is added to the PU running frequency.

◆ Frequency setting storage

- When **Pr.59** = "1", the remotely-set frequency (frequency set by RH/RM operation) is stored to the memory (EEPROM). When power is switched OFF once, then ON, operation is resumed with the stored set frequency.
- When **Pr.59** = "2 or 3", the set frequency is not stored, so when switching the power ON again after being switched OFF, the remotely-set frequency becomes 0 Hz.
- The remotely-set frequency is stored at the point when the start signal (STF or STR) turns OFF. Remotely-set frequency is stored every minute after turning OFF (ON) the RH and RM signals together. Every minute, the frequency is overwritten in the EEPROM if the latest frequency is different from the previous one when comparing the two. This cannot be written with RL signals.

NOTE

- When switching the start signal from ON to OFF, or changing frequency by the RH or RM signal frequently, set the frequency setting value storage function (write to EEPROM) invalid (**Pr.59** = "2 or 3"). If the frequency setting value storage function is valid (**Pr.59** = "1"), the frequency is written to EEPROM frequently, and this will shorten the life of the EEPROM.

◆ Clearing the settings

- When **Pr.59** = "1 or 2" and the clear (RL) signal is turned ON, the remotely-set frequency is cleared. When **Pr.59** = "3" and the STF or STR signal is turned OFF, the remotely-set frequency is cleared.

NOTE

- The range of frequency changeable by acceleration (RH) signal and deceleration (RM) signal is 0 to maximum frequency (Pr.1 or Pr.18 setting). Note that the maximum value of set frequency is (main speed + maximum frequency).

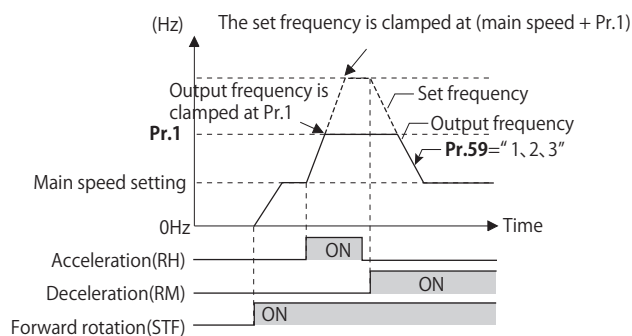

- Even if the start signal (STF or STR) is OFF, turning ON the RH or RM signal varies the preset frequency.
- The RH, RM, or RL signal can be assigned to an input terminal by setting Pr.178 to Pr.182 (Input terminal function selection). Changing the terminal assignment may affect other functions. Set parameters after confirming the function of each terminal.
- The inverter can be used in the Network operation mode.
- The remote setting function is invalid during JOG operation and PID control operation.
- The multi-speed operation function is invalid when remote setting function is selected.

Setting frequency is "0".

- Even when the remotely-set frequency is cleared by turning ON the RL (clear) signal after turning OFF (ON) both the RH and RM signals, the inverter operates at the remotely-set frequency stored in the last operation if power is reapplied before one minute has elapsed since turning OFF (ON) both the RH and RM signals.

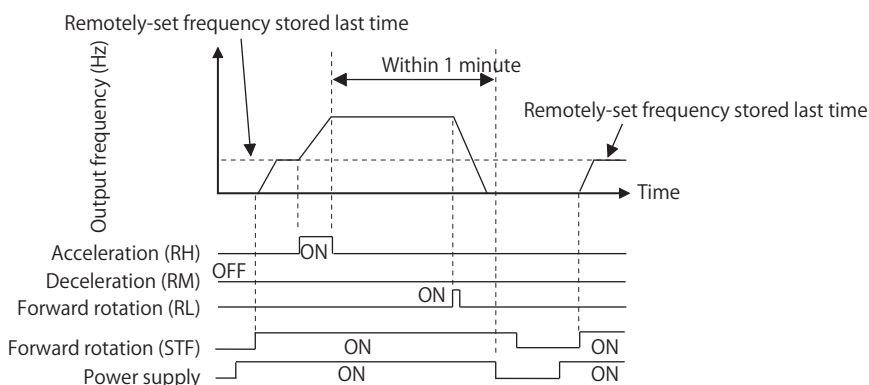

- When the remotely-set frequency is cleared by turning ON the RL (clear) signal after turning OFF (ON) both the RH and RM signals, the inverter operates at the frequency in the remotely-set frequency cleared state if power is reapplied before one minute has elapsed since turning OFF (ON) both the RH and RM signals.

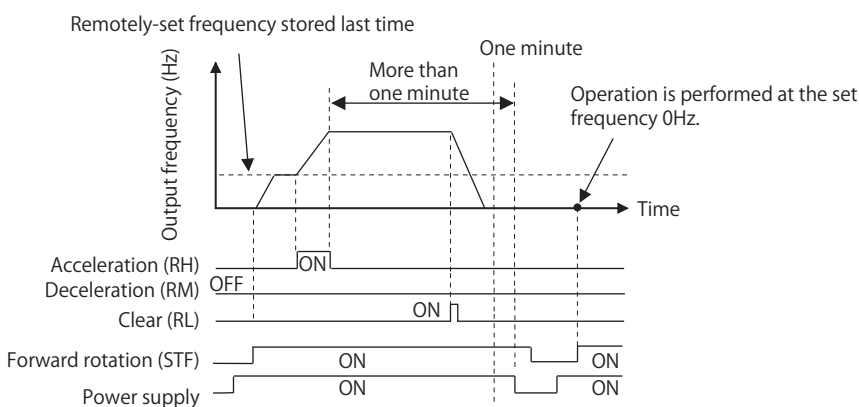

CAUTION

- When using the remote setting function, set the maximum frequency again according to the machine.

« Parameters referred to »

Pr.1 Maximum frequency, Pr.18 High speed maximum frequency [page 117](#)

Pr.7 Acceleration time, Pr.8 Deceleration time, Pr.44 Second acceleration/deceleration time, Pr.45 Second deceleration time [page 93](#)

Pr.178 to Pr.182 (Input terminal function selection) [page 142](#)

5.4.4 Starting frequency

It is possible to set the starting frequency.

Set this function when a starting torque is needed or the motor drive at start needs smoothing.

Pr.	Name	Initial value	Setting range	Description
13 F102	Starting frequency	0.5 Hz	0 to 60 Hz	Set the starting frequency at which the start signal is turned ON.

◆ Starting frequency setting (Pr.13)

- The frequency at start can be set in the range of 0 to 60 Hz.
- Set the starting frequency at which the start signal is turned ON.

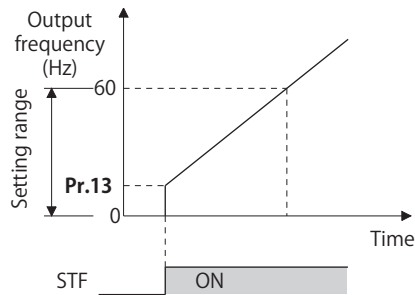

NOTE

- The inverter does not start if the frequency setting signal has a value lower than that of **Pr.13**.
For example, while **Pr.13** = 5 Hz, the inverter output starts when the frequency setting signal reaches 5 Hz.

⚠ CAUTION

- Note that when **Pr.13** is set to any value equal to or lower than **Pr.2 Minimum frequency**, simply turning ON the start signal runs the motor at the frequency set in **Pr.2** even if the command frequency is not given.

« Parameters referred to »

Pr.2 Minimum frequency [page 117](#)

5.5 (D) Operation command and frequency command

Purpose	Parameter to set			Refer to page
To select the operation mode	Operation mode selection	P.D000	Pr.79	100
To start up the inverter in Network operation mode at power-ON	Communication startup mode selection	P.D000, P.D001	Pr.79, Pr.340	104
To select the command source during communication operation	Operation and speed command sources during communication operation, command source selection	P.D010, P.D011, P.D013	Pr.338, Pr.339, Pr.551	105
To prevent the motor from rotating reversely	Reverse rotation prevention selection	P.D020	Pr.78	108
To perform JOG (inching) operation	JOG operation	P.D200, P.F002	Pr.15, Pr.16	108
To control the frequency with combinations of terminals	Multi-speed operation	P.D301 to P.D315	Pr.4 to Pr.6, Pr.24 to Pr.27, Pr.232 to Pr.239	109

5.5.1 Operation mode selection

Select the operation mode of the inverter.

The mode can be changed among operations using external signals (External operation), operation by the PU such as the operation panel or parameter unit (PU operation), combined operation of PU operation and External operation (External/PU combined operation), and Network operation.

Pr.	Name	Initial value	Setting range	Description
79 D000	Operation mode selection	0	0 to 4	Select the operation mode.

The following table lists valid and invalid commands in each operation mode.

Pr.79 setting	Description			LED display : OFF : ON : ON (blinking)	Refer to page
0 (initial value)	External/PU switchover mode. The inverter operation mode can be switched between PU and External. At power ON, the inverter is in the External operation mode.			PU operation mode External operation mode NET operation mode 	103
1	Operation mode	Frequency command	Start command	PU operation mode 	104
	PU operation mode fixed	Input from the operation panel or parameter unit	on the operation panel or or on the parameter unit		
2	External operation mode fixed. The operation can be performed by switching between the External and NET operation modes.	External signal input (via terminal 2 or 4, for JOG operation, or for the multi-speed selection function, etc.)	External signal input (via terminal STF or STR)	External operation mode NET operation mode 	103
3	External/PU combined operation mode 1	Input from the operation panel or parameter unit, or the external signal input (via terminal 4 or for the multi-speed selection function, etc.) ^{*1}	External signal input (via terminal STF or STR)	External/PU combined operation mode 	104
4	External/PU combined operation mode 2	External signal input (via terminal 2 or 4, for JOG operation, or for the multi-speed selection function, etc.)	on the operation panel or or on the parameter unit		104

*1 The priorities of the frequency commands while Pr.79 = "3" are "Multi-speed operation (RL/RM/RH/REX) > PID control (X14) > terminal 4 analog input (AU) > digital input from the operation panel".

◆ Operation mode basics

- The operation mode specifies the source of the start command and the frequency command for the inverter.
- Basically, there are following operation modes.

External operation mode : For giving a start command and a frequency command with an external potentiometer or switches which are connected to the control circuit terminal.

PU operation mode : For giving a start command and a frequency command from the PU or through RS-485 communication via the PU connector.

Network operation mode (NET operation mode) : For giving a start command and a frequency command through communication via the PU connector.

- The operation mode can be selected from the operation panel or with the communication instruction code.

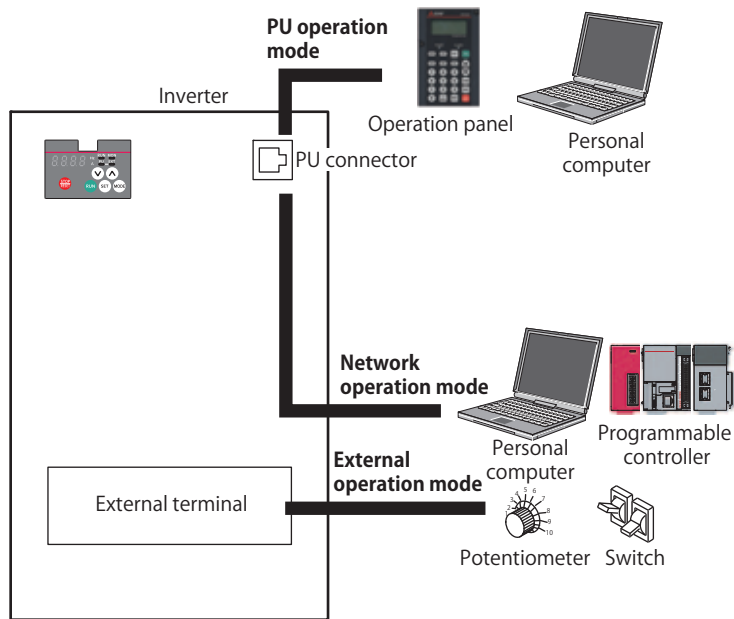

NOTE

- There is a choice of two settings, "3" and "4", for the External/PU combined operation mode. The startup method differs according to the setting value.
- The PU stop function (stopping the operation by pressing  on the operation panel or the parameter unit) is initially enabled in any operation mode as well as in the PU operation mode. (Refer to **Pr.75 Reset selection/disconnected PU detection/PU stop selection** on [page 85](#)).

◆ Operation mode selection flow

Referring to the following table, select the basic parameter settings or terminal wiring related to the operation mode.

Method to give start command	Frequency setting method	Input terminal	Parameter setting	Operation method
Input with the external signal (via terminal STF/STR)	Input with the external signal (via terminal 2, 4, or JOG, or using the multi-speed selection function, etc.)	Terminal STF (for forward rotation) / STR (for reverse rotation) (refer to page 145), terminal 2 (analog), 4 (analog), RL, RM, RH, JOG, etc.	Pr.79 = "2" (External operation mode fixed)	<ul style="list-style-type: none"> Frequency setting: Turn ON a signal for frequency setting Start command: Turn ON the STF/STR signal
	Input from the PU (digital setting)	Terminal STF (for forward rotation) / STR (for reverse rotation) (refer to page 145 .)	Pr.79 = "3" (External/PU combined operation mode 1)	<ul style="list-style-type: none"> Frequency setting: Digital setting Start command: Turn ON the STF/STR signal
	Input through communication (via the PU connector)	Terminal STF (for forward rotation) / STR (for reverse rotation) (refer to page 145), terminals for RS-485 communication	Pr.338 = "1" Pr.340 = "1 or 2"	<ul style="list-style-type: none"> Frequency setting: Transmit a frequency command via communication. Start command: Turn ON the STF/STR signal
Input from the PU	Input with the external signal (via terminal 2, 4, or JOG, or using the multi-speed selection function, etc.)	Terminal 2 (analog), 4 (analog), RL, RM, RH, JOG, etc.	Pr.79 = "4" (External/PU combined operation mode 2)	<ul style="list-style-type: none"> Frequency setting: Turn ON a signal for frequency setting Start command: Press the RUN/FWD/REV key
	Input from the PU (digital setting)	—	Pr.79 = "1" (PU operation mode fixed)	<ul style="list-style-type: none"> Frequency setting: Digital setting Start command: Press the RUN/FWD/REV key
Input through communication (via the PU connector)	Input with the external signal (via terminal 2, 4, or JOG, or using the multi-speed selection function, etc.)	Terminals for RS-485 communication, terminal 2 (analog), 4 (analog), RL, RM, RH, JOG, etc.	Pr.339 = "1" Pr.340 = "1 or 2"	<ul style="list-style-type: none"> Frequency setting: Turn ON a signal for frequency setting Start command: Transmit a start command via communication
	Input from the PU (digital setting)	Not available		
	Input through communication (via the PU connector)	—		Pr.340 = "1 or 2"

◆ External operation mode (Pr.79 = "0" (initial value) or "2")

- Select the External operation mode when the start command and the frequency command are applied from a frequency setting potentiometer, start switch, etc. which are provided externally and connected to the control circuit terminals of the inverter.
- Generally, parameter change cannot be performed in the External operation mode. (Some parameters can be changed. Refer to [Pr.77](#) on [page 89](#).)
- When Pr.79 = "0 or 2", the inverter starts up in the External operation mode at power-ON. (To start up the inverter in the Network operation mode, refer to [page 104](#).)
- When parameter changing is seldom necessary, setting "2" fixes the operation mode to the External operation mode.

- The STF and STR signal are used as a start command, and the voltage to terminal 2 and 4, current signal, multi-speed signal, and JOG signal are used as a frequency command.

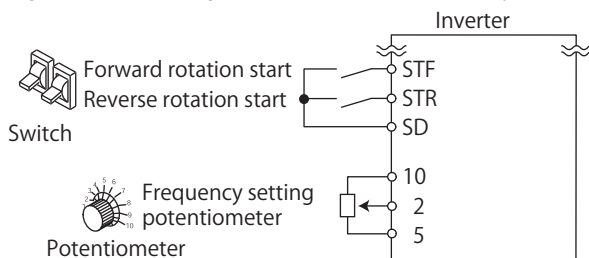

◆ PU operation mode (Pr.79 = "1")

- Select the PU operation mode when applying start and speed commands only using keys on the PU. Also select the PU operation mode to operate through communication via the PU connector.
- When Pr.79 = "1", the inverter starts up in the PU operation mode at power-ON. The mode cannot be changed to other operation mode.

◆ PU/External combined operation mode 1 (Pr.79 = "3")

- Select the PU/External combined operation mode 1 when giving a frequency command from the operation panel or the parameter unit and giving a start command with the external start switches.
- Set "3" in Pr.79. The mode cannot be changed to other operation mode.
- When a frequency command is given from the external signal by multi-speed setting, it has a higher priority than the frequency command from the PU. Also, when AU is set to "ON", the command signal is output via terminal 4.

◆ PU/External combined operation mode 2 (Pr.79 = "4")

- Select the PU/External combined operation mode 2 when giving a frequency command from the external potentiometer, or multi-speed and JOG signals, and giving a start command by key operation of the operation panel or the parameter unit.
- Set "4" in Pr.79. The mode cannot be changed to other operation modes.

◀ Parameters referred to ▶▶

- Pr.15 Jog frequency [page 108](#)
- Pr.4 to Pr.6, Pr.24 to 27, Pr.232 to Pr.239 (Multi-speed operation) [page 109](#)
- Pr.75 Reset selection/disconnected PU detection/PU stop selection [page 85](#)
- Pr.161 Frequency setting/key lock operation selection [page 88](#)
- Pr.178 to Pr.182 (Input terminal function selection) [page 142](#)
- Pr.340 Communication startup mode selection [page 104](#)

5.5.2 Startup of the inverter in the Network operation mode at power-ON

When power is switched ON or when power comes back ON after an instantaneous power failure, the inverter can be started up in the Network operation mode.

After the inverter starts up in the Network operation mode, parameter writing and operation can be commanded from programs. Set this mode for communication operation via the PU connector.

Pr.	Name	Initial value	Setting range	Description
79 D000	Operation mode selection	0	0 to 4	Select the operation mode. (Refer to page 100 .)
340 D001	Communication startup mode selection	0	0	The inverter starts up in an operation mode selected by the Pr.79.
			1	The inverter starts up in the Network operation mode.
			10	The inverter starts up in the Network operation mode. The operation mode can be changed on the operation panel between the PU operation mode and Network operation mode.

◆ Selecting the operation mode for power-ON (Pr.340)

- Depending on the Pr.79 and Pr.340 settings, the operation mode at power-ON (reset) changes as described below.

Pr.340 setting	Pr.79 setting	Operation mode at power-ON, at power restoration, or after a reset	Operation mode switching
0 (initial value)	0 (initial value)	External operation mode	Switching among the External, PU, and NET operation modes is enabled.*1
	1	PU operation mode	PU operation mode fixed
	2	External operation mode	Switching among the External, NET operation modes is enabled. Switching to PU operation mode is disabled.
	3, 4	External/PU combined operation mode	Operation mode switching is disabled
1	0	NET operation mode	Same as Pr.340 = "0" setting.
	1	PU operation mode	
	2	NET operation mode	
	3, 4	External/PU combined operation mode	
10	0	NET operation mode	Switching between the PU and NET operation mode is enabled.
	1	PU operation mode	Same as Pr.340 = "0" setting.
	2	NET operation mode	NET operation mode fixed
	3, 4	External/PU combined operation mode	Same as Pr.340 = "0" setting.

*1 The operation mode cannot be directly changed between the PU operation mode and Network operation mode.

Parameters referred to

Pr.79 Operation mode selection [page 100](#)

5.5.3 Command interface/source for start command and frequency command during communication operation

The start and frequency commands can be given via the PU connector using the external signals. The command interface/source enabled in the PU operation mode can also be selected.

Pr.	Name	Initial value	Setting range	Description
338 D010	Communication operation command source	0	0	The start command is given through communication during communication operation.
			1	The start command is given using the external signals during communication operation.
339 D011	Communication speed command source	0	0	The frequency setting command for speed setting is given through communication during communication operation.
			1	The frequency setting command for speed setting is given using the external signals during communication operation.
			2	The frequency setting command can be given using the external signals (via terminal 4) or through communication, and the command given using the external signals has higher priority. (Commanding via terminal 2 is disabled.)
551 D013	PU mode operation command source selection	9999	2	The PU connector is the command interface enabled in the PU operation mode.
			4	The operation panel is the command source enabled in the PU operation mode.
			9999	Automatic detection of the PU connector. Normally, the operation panel is the command source. When the PU is connected to the PU connector, the command source is switched to the PU.

◆ Selecting the command interface/source enabled in the PU operation mode (Pr.551)

- The command interface/source enabled in the PU operation mode can be selected between the PU connector and the operation panel.

NOTE

- The changed value is applied after the next power-ON or inverter reset.

◆ Controllability through communication

Command interface	Condition (Pr.551 setting)	Item	Controllability in each operation mode				
			PU operation	External operation	External/PU combined operation 1 (Pr.79 = "3")	External/PU combined operation 2 (Pr.79 = "4")	NET operation
PU connector through RS-485 communication	2 (PU connector) or 9999 (Automatic detection of the PU connector)	Operation (start) command	○	×	×	○	×
		Operation (stop) command	○	Δ ^{*2}	Δ ^{*2}	○	Δ ^{*2}
		Running frequency setting	○	×	○	×	×
		Monitoring	○	○	○	○	○
		Parameter write	○ ^{*3}	×	○ ^{*3}	○ ^{*3}	×
		Parameter read	○	○	○	○	○
		Inverter reset	○	○	○	○	○
	4	Operation (start) command	×	×	×	×	×
		Operation (stop) command	Δ ^{*2}	Δ ^{*2}	Δ ^{*2}	Δ ^{*2}	Δ ^{*2}
		Running frequency setting	×	×	×	×	×
		Monitoring	○	○	○	○	○
		Parameter write	×	×	×	×	×
		Parameter read	○	○	○	○	○
		Inverter reset	○	○	○	○	○
External control circuit terminal	—	Inverter reset	○	○	○	○	○
		Operation command (start, stop)	×	○	○	×	×
		Frequency setting	×	○	×	○	×

○: Enabled, ×: Disabled, Δ: Partially enabled

- *1 The inverter operates according to the settings of **Pr.338 Communication operation command source** and **Pr.339 Communication speed command source**. (Refer to [page 105](#).)
- *2 Only the PU stop function is enabled. The indication "PS" is displayed on the PU at a stop by the PU stop function. The inverter operates according to the setting of **Pr.75 Reset selection/PU stop selection**. (Refer to [page 85](#).)
- *3 Writing of some parameters may be disabled depending on the setting of **Pr.77 Parameter write selection** and the operating condition. (Refer to [page 89](#).)
- *4 Some parameters are write-enabled independently of the operation mode and command source enabled/disabled. Writing is also enabled when **Pr.77 = "2"** (refer to [page 89](#)). Parameter clear is disabled.

◆ Operation when a communication error occurs

Fault type	Condition (Pr.551 setting)	Operation in each operation mode at error occurrences				
		PU operation	External operation	External/PU combined operation mode 1 (Pr.79 = "3")	External/PU combined operation mode 2 (Pr.79 = "4")	NET operation
Inverter fault	—	Stop				
PU connector disconnection	2 (PU connector) 9999 (automatic recognition)	Stop/continued ^{*1*3}				
	4	Stop/continued ^{*1}				
Communication error at PU connector	2 (PU connector)	Stop/continued ^{*2}	Continued		Stop/continued ^{*2}	Continued
	4	Continued				

- *1 Selectable with **Pr.75 Reset selection/disconnected PU detection/PU stop selection**.
- *2 Selectable with **Pr.122 PU communication check time interval**.

*3 In the PU JOG operation mode, the operation always stops when the PU is disconnected. The operation at a PU disconnection fault (E.PUE) occurrence is as set in Pr.75 Reset selection/Disconnected PU detection/PU Stop selection.

◆ Selecting the command interface enabled in the Network operation mode (Pr.338, Pr.339)

- Selecting a command interface is required for the following two commands: the operation command using the start signals and the signals related to the inverter function selection, and the speed command using signals related to the frequency setting.
- The following table shows the command interface enabled in the Network operation mode: the external terminal or the PU connector for communication operation.

Command interface selection	Pr.338 (Communication operation command source) setting			0: NET			1: EXT			Remarks
	Pr.339 (Communication speed command source) setting			0: NET	1: EXT	2: EXT	0: NET	1: EXT	2: EXT	
Unique function (terminal-specific function)	Running frequency command given through communication			NET	—	NET	NET	—	NET	
	Terminal 2			—	EXT	—	—	EXT	—	
	Terminal 4			—	EXT	—	—	EXT	—	
Terminal-selectable function Setting of Pr.178 to Pr.182	0	RL	Low-speed operation command / Remote setting (setting clear) / Stop-on-contact selection 0	NET	EXT	—	NET	EXT	—	When Pr.59 = "0": Multi-speed, when Pr.59 ≠ "0": Remote
	1	RM	Middle-speed operation command / remote setting (deceleration)	NET	EXT	—	NET	EXT	—	
	2	RH	High-speed operation command / remote setting (acceleration)	NET	EXT	—	NET	EXT	—	
	3	RT	Second function selection / stop-on-contact selection 1	NET			EXT			
	4	AU	Terminal 4 input selection	—	Combined		—	Combined		
	5	JOG	JOG operation selection	—			EXT			
	7	OH	External thermal relay input	EXT			—			
	8	REX	15-speed selection	NET	EXT	—	NET	EXT	—	When Pr.59 = "0": Multi-speed
	10	X10	Inverter run enable	EXT			—			
	14	X14	PID control valid	NET	EXT	—	NET	EXT	—	
	24	MRS	Output stop	Combined			EXT			
			PU operation interlock	EXT			—			
	25	STP (STOP)	Start self-holding selection	—			EXT			
	37	X37	Traverse function selection	NET			EXT			
60	STF	Forward rotation command	NET			EXT				
61	STR	Reverse rotation command	NET			EXT				
62	RES	Inverter reset	EXT			—				

[Explanation of Terms in Table]

EXT: The external terminal is the only enabled command interface.

NET: The PU connector (for communication operation) is the only enabled command interface.

Combined: Either interface (the external terminal or PU connector) is enabled.

—: Both interfaces (the external terminal and PU connector) are disabled.

NOTE

- The command interface/source for communication operation depends on the Pr.551 setting.
- The settings of Pr.338 and Pr.339 can be changed while the inverter is running when Pr.77 = "2". Note that the setting change is applied after the inverter has stopped. Until the inverter has stopped, communication operation command source and communication speed command source before the setting change are valid.

5.5.4 Reverse rotation prevention selection

This function can prevent reverse rotation fault resulting from the incorrect input of the start signal.

Pr.	Name	Initial value	Setting range	Description
78 D020	Reverse rotation prevention selection	0	0	Both forward and reverse rotations allowed
			1	Reverse rotation disabled
			2	Forward rotation disabled

- Set this parameter to limit the motor rotation to only one direction.
- This parameter is valid for all of the reverse rotation and forward rotation keys of the operation panel and of the parameter unit, the start signals (STF, STR signals) via external terminals, and the forward and reverse rotation commands through communication.

5.5.5 JOG operation

The frequency and acceleration/deceleration time for JOG operation can be set. JOG operation is possible in both External operation and PU.

JOG operation can be used for conveyor positioning, test operation, etc.

Pr.	Name	Initial value	Setting range	Description
15 D200	Jog frequency	5 Hz	0 to 400 Hz	Set the frequency during JOG operation.
16 F002	Jog acceleration/ deceleration time	0.5 s	0 to 3600 s	Set the motor acceleration/deceleration time during JOG operation. For the acceleration/deceleration time, set the time until the frequency*1 set in Pr.20 Acceleration/deceleration reference frequency is reached. The acceleration/deceleration times cannot be set separately.

*1 The Initial value of the **Pr.20** is set to 50 Hz.

◆ JOG operation using the External signals

- Operation can be started and stopped by the start signals (STF and STR signals) when the Jog operation selection (JOG) signal is ON.
- Use Jog acceleration/deceleration time (**Pr.16**) to set the acceleration/deceleration time during JOG operation.
- For each signal, refer to the following table and assign the function by using any of **Pr.178 to Pr.189 (Input terminal function selection)**.

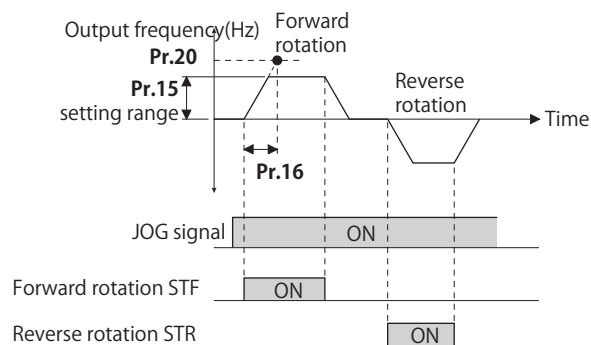

Input signal	Setting of Pr.178 to Pr.182
JOG	5



◆ JOG operation using the PU

- When the operation panel or parameter unit is in the JOG operation mode, the motor runs only while a key for start command is pressed.

NOTE

- The reference frequency during acceleration/deceleration depends on the setting of **Pr.29 Acceleration/deceleration pattern selection**. (Refer to [page 95](#).)
- The **Pr.15** setting should be equal to or higher than the setting of **Pr.13 Starting frequency**.
- The JOG signal can be assigned to an input terminal by setting **Pr.178 to Pr.182 (Input terminal function selection)**. Changing the terminal assignment may affect other functions. Set parameters after confirming the function of each terminal.
- When Pr.79 Operation mode selection = "4", the JOG operation starts/stops with one push of   on the operation panel.
- The JOG operation using the PU is disabled when Pr.79 = "3".

◀ Parameters referred to ▶

- Pr.13 Starting frequency [page 99](#)
 Pr.20 Acceleration/deceleration reference frequency, Pr.21 Acceleration/deceleration time increments [page 93](#)
 Pr.29 Acceleration/deceleration pattern selection [page 95](#)
 Pr.79 Operation mode selection [page 100](#)
 Pr.178 to Pr.182 (Input terminal function selection) [page 142](#)

5.5.6 Operation by multi-speed setting

Use these parameters to change among pre-set operation speeds with the terminals. The speeds are pre-set with parameters. Any speed can be selected by simply turning ON/OFF the contact signals (RH, RM, RL, and REX signals).

Pr.	Name	Initial value	Setting range	Description
28 D300	Multi-speed input compensation selection	0	0	Without compensation
			1	With compensation
4 D301	Multi-speed setting (high speed)	50 Hz	0 to 400 Hz	Sets the frequency when RH is ON.
5 D302	Multi-speed setting (middle speed)	30 Hz	0 to 400 Hz	Sets the frequency when RM is ON.
6 D303	Multi-speed setting (low speed)	10 Hz	0 to 400 Hz	Sets the frequency when RL is ON.
24 D304	Multi-speed setting (speed 4)	9999	0 to 400 Hz, 9999	Frequency from 4th speed to 15th speed can be set according to the combination of the RH, RM, RL and REX signals. 9999: Not selected
25 D305	Multi-speed setting (speed 5)			
26 D306	Multi-speed setting (speed 6)			
27 D307	Multi-speed setting (speed 7)			
232 D308	Multi-speed setting (speed 8)			
233 D309	Multi-speed setting (speed 9)			
234 D310	Multi-speed setting (speed 10)			
235 D311	Multi-speed setting (speed 11)			
236 D312	Multi-speed setting (speed 12)			
237 D313	Multi-speed setting (speed 13)			
238 D314	Multi-speed setting (speed 14)			
239 D315	Multi-speed setting (speed 15)			

◆ Multi-speed setting (Pr.4 to Pr.6)

- The inverter operates at frequencies set in Pr.4 when the RH signal is ON, Pr.5 when the RM signal is ON and Pr.6 when the RL signal is ON.

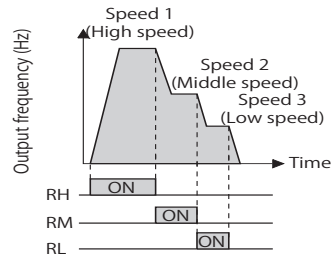
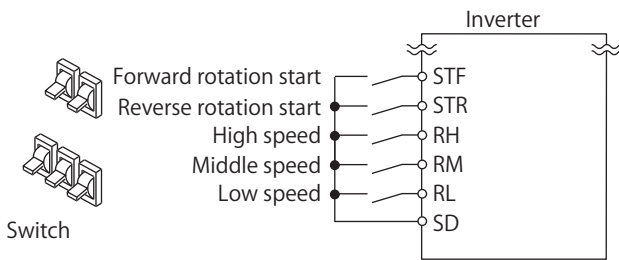

NOTE

- In the initial setting, if two or more speed switches (signals) are simultaneously turned ON, priority is given to the switch (signal) for the lower speed. For example, when both RH and RM signals turn ON, the RM signal (Pr.5) has the higher priority.
- The RH, RM and RL signals are assigned to the terminals RH, RM and RL in the initial status. Set "0 (RL)", "1 (RM)", and "2 (RH)" in any of Pr.178 to Pr.182 (Input terminal function selection) to assign the signals to other terminals.

◆ Multi-speed setting for 4th speed or more (Pr.24 to Pr.27, Pr.232 to Pr.239)

- The frequency from 4th speed to 15th speed can be set according to the combination of the RH, RM, RL, and REX signals. Set the running frequencies in **Pr.24 to Pr.27, Pr.232 to Pr.239**. (In the initial status, 4th to 15th speeds are invalid.)
- For the terminal used for REX signal input, set "8" in any of **Pr.178 to Pr.182 (Input terminal function selection)** to assign the function.

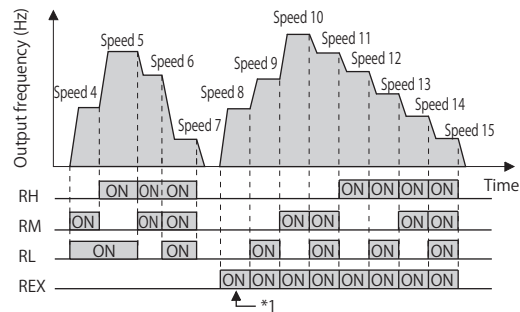
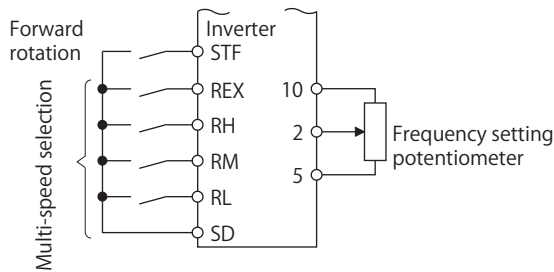

*1 When the RH, RM and RL signals are OFF and the REX signal is ON while **Pr.232 Multi-speed setting (speed 8) = "9999"**, the inverter runs at the frequency set in **Pr.6**.

NOTE

- The priority of the frequency commands given by the external signals are "JOG operation > multi-speed operation > terminal 4 analog input > pulse train input > terminal 2 analog input". (For details on frequency commands given by analog input, refer to [page 134](#).)
- The multi-speed setting for 4th speed or more is enabled in the External operation mode or PU/External combined operation mode (when **Pr.79 = "3 or 4"**).
- Multi-speed parameters can also be set during PU operation or External operation.
- The settings of **Pr.24 to Pr.27, Pr.232 to Pr.239** are not prioritized.
- When **Pr.59 Remote function selection ≠ "0"**, the multi-speed setting is disabled since the RH, RM, and RL signals are used for remote setting.
- Use **Pr.73 Analog input selection** to select the characteristic of terminal 2 (terminal to input compensation voltage (0 to ±5 V / 0 to ±10 V)).
- Changing the terminal assignment using **Pr.178 to Pr.182 (Input terminal function selection)** may affect the other functions. Set parameters after confirming the function of each terminal.

Parameters referred to

Pr.15 Jog frequency [page 108](#)

Pr.59 Remote function selection [page 96](#)

Pr.73 Analog input selection [page 131](#)

Pr.79 Operation mode selection [page 100](#)

Pr.178 to Pr.182 (Input terminal function selection) [page 142](#)

5.6 (H) Protective function parameter

Purpose	Parameter to set			Refer to page
To protect the motor from overheating	Electronic thermal O/L relay	P.H000	Pr.9	112
To detect an earth (ground) fault at start	Earth (ground) fault detection at start	P.H101	Pr.249	114
To disable the I/O phase loss protective function	I/O phase loss	P.H200, P.H201	Pr.251, Pr.872	115
To restart using the retry function when the protective function is activated	Retry operation	P.H300 to P.H303	Pr.65, Pr.67 to Pr.69	115
To set the upper and lower limits of the output frequency	Maximum/minimum frequency	P.H400 to P.H402	Pr.1, Pr.2, Pr.18	117
To operate avoiding resonance points	Frequency jump	P.H420 to P.H425	Pr.31 to Pr.36	118
To limit the output current so that the inverter protective function does not activate	Stall prevention	P.H500, P.H501, P.H610, P.H611, P.M430	Pr.22, Pr.23, Pr.66, Pr.156, Pr.157	119

5.6.1 Motor overheat protection (electronic thermal O/L relay)

Set the current of the electronic thermal O/L relay function to protect the motor from overheating. Such settings provide the optimum protective characteristic considering the low cooling capability of the motor during low-speed operation.

Pr.	Name	Initial value	Setting range	Description
9 H000	Electronic thermal O/L relay	Inverter rated current	0 to 500 A	Set the rated motor current.

◆ Electronic thermal O/L relay operation characteristic for induction motor (Pr.9)

- This function detects the overload (overheat) of the motor and shut off the inverter output by stopping the operation of the transistor at the inverter output side.
- Set the rated motor current (A) in **Pr.9 Electronic thermal O/L relay**. (If the motor has both 50 Hz and 60 Hz ratings and the **Pr.3 Base frequency** is set to 60 Hz, set to 1.1 times the 60 Hz rated motor current.)
- Set "0" in Pr.9 to avoid activating the electronic thermal O/L relay function in cases such as when using an external thermal relay for the motor.

(Note that the output transistor protection of the inverter is activated. (E.THT))

- When using the Mitsubishi Electric constant-torque motor, set "1" in **Pr.71 Applied motor**. (This setting enables the 100% constant-torque characteristic in the low-speed range.)

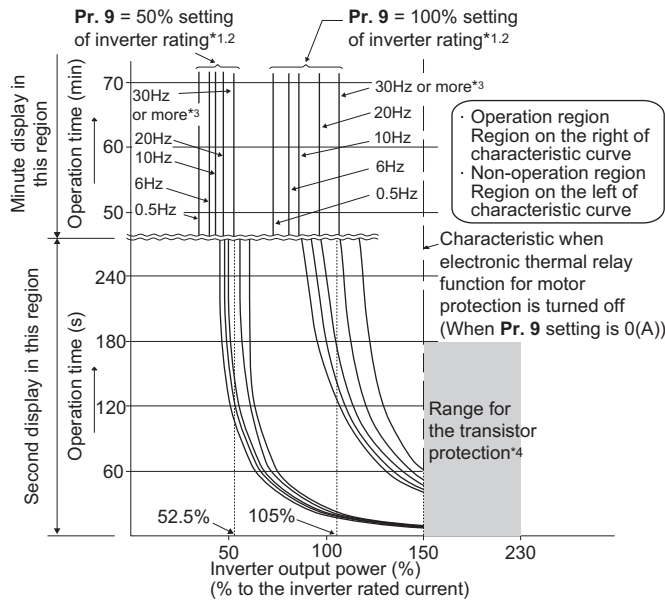

- *1 When setting **Pr.9** to a value (current value) of 50% of the inverter rated current
- *2 The % value denotes the percentage to the rated inverter current. It is not the percentage to the rated motor current.
- *3 When you set the electronic thermal relay function dedicated to the Mitsubishi Electric constant-torque motor, this characteristic curve applies to operation at 6 Hz or higher. (For selection of the operation characteristic, refer to [page 147](#).)
- *4 Transistor protection is activated depending on the temperature of the heatsink. The protection may be activated even with less than 150% depending on the operating conditions.

NOTE

- The internal accumulated heat value of the electronic thermal O/L relay is reset to the initial value by the inverter's power reset or reset signal input. Avoid unnecessary reset and power-OFF.
- Install an external thermal relay (OCR) between the inverter and motors to operate several motors, a multi-pole motor or a dedicated motor with one inverter. When setting an external thermal relay, note that the current indicated on the motor rating plate is affected by the line-to-line leakage current. (Refer to [page 48](#).) The cooling effect of the motor drops during low-speed operation. Use a thermal protector or a motor with built-in thermistor.
- The protective characteristic of the electronic thermal O/L relay is degraded when there is a large difference in capacity between the inverter and motor, and when the set value is small. In this case, use an external thermal relay.
- Dedicated motors cannot be protected by an electronic thermal O/L relay. Use an external thermal relay.
- The transistor protection thermal O/L relay is activated earlier when the **Pr.72 PWM frequency selection** setting is increased.

◆ **Electronic thermal O/L relay pre-alarm (TH) and warning signal (THP signal)**

- If the accumulated electronic thermal value reaches 85% of the **Pr.9** setting, electronic thermal O/L relay function pre-alarm (TH) is displayed and the electronic thermal O/L relay pre-alarm (THP) signal is output. If the value reaches 100% of the **Pr.9** setting, the electronic thermal O/L relay function (E.THM/E.THT) is activated to shut off the inverter output. The inverter output is not shut off with the TH display.
- For the terminal used for the THP signal, assign the function by setting "8 (positive logic) or 108 (negative logic)" in **Pr.195** (Output terminal function selection).

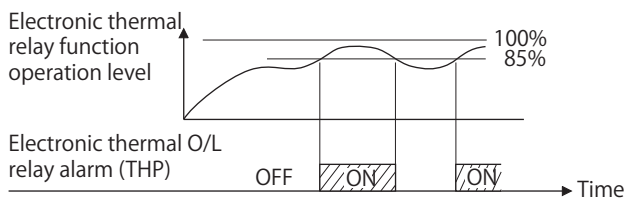

NOTE

- Changing the terminal assignment using **Pr.195 (Output terminal function selection)** may affect the other functions. Set parameters after confirming the function of each terminal.

◆ External thermal relay input (OH signal, E.OHT)

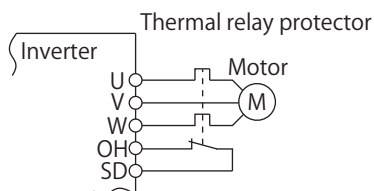

External thermal relay input connection diagram

- The External thermal relay input (OH) signal is used when using the external thermal relay or the thermal protector built into the motor to protect the motor from overheating.
- When the thermal relay is activated, the inverter output is shut off by the external thermal relay operation (E.OHT).
- For the terminal used for the OH signal input, set "7" in any of **Pr.178 to Pr.182 (Input terminal function selection)** to assign the function.

NOTE

- Changing the terminal assignment using **Pr.178 to Pr.182 (Input terminal function selection)** may affect the other functions. Set parameters after confirming the function of each terminal.

Parameters referred to

Pr.71 Applied motor [page 147](#)

Pr.72 PWM frequency selection [page 92](#)

Pr.178 to Pr.182 (Input terminal function selection) [page 142](#)

Pr.195 (Output terminal function selection) [page 126](#)

5.6.2 Earth (ground) fault detection at start

Select whether to make earth (ground) fault detection at start. When enabled, earth (ground) fault detection is performed immediately after a start signal input to the inverter.

Pr.	Name	Initial value	Setting range	Description
249 H101	Earth (ground) fault detection at start	1	0	Without the earth (ground) fault detection at start
			1	With the earth (ground) fault detection at start

- If a ground fault is detected at start while **Pr.249** = "1", the output-side earth (ground) fault overcurrent (E.GF) is displayed and the output is shut off. (Refer to [page 217](#).)
- **Pr.249** setting is enabled during V/F control and General-purpose magnetic flux vector control.

NOTE

- Because the detection is performed at start, output is delayed for approx. 20 ms every start.
- Use **Pr.249** to enable/disable earth (ground) fault detection at operation start. During operation, earth (ground) faults are detected regardless of the **Pr.249** setting.

5.6.3 Inverter output fault detection enable/disable selection

Faults occurred on the inverter output side (load side) during operation (inverter output fault (E.E10)) can be detected.

Pr.	Name	Initial value	Setting range	Description
631 H104	Inverter output fault detection enable/disable selection	1	0	Output fault detection disabled
			1	Output fault detection enabled

- When the **Pr.72 PWM frequency selection** setting is high, enable the ground fault detection at start.

5.6.4 Undervoltage detection enable/disable selection

A fault caused by unstable power supply voltage (undervoltage (E.UVT)) can be detected.

Pr.	Name	Initial value	Setting range	Description
598 H105	Undervoltage detection enable/disable selection	1	0	Undervoltage detection disabled
			1	Undervoltage detection enabled

5.6.5 I/O phase loss protection selection

The output phase loss protection function, which stops the inverter output if one of the three phases (U, V, W) on the inverter's output side (load side) is lost, can be disabled.

The input phase loss protective function on the inverter input side (R/L1, S/L2, T/L3) can be enabled.

Pr.	Name	Initial value	Setting range	Description
251 H200	Output phase loss protection selection	1	0	Without output phase loss protection
			1	With output phase loss protection
872 H201	Input phase loss protection selection	1	0	Without input phase loss protection
			1	With input phase loss protection

5

◆ Output phase loss protection selection (Pr.251)

- When Pr.251 is set to "0", output phase loss protection (E.LF) becomes invalid.

◆ Input phase loss protection selection (Pr.872)

- When Pr.872 is set to "1", input phase loss (E.ILF) protection is activated if one of three phases is detected to be lost for 1 second continuously.

NOTE

- When multiple motors are connected, output phase loss cannot be detected if the wiring to one motor loses phase.
- If the load is light or during a stop, lost phase cannot be detected because detection is performed based on the fluctuation of bus voltage. Large unbalanced phase-to-phase voltage of the three-phase power supply may also cause input phase loss protection (E.ILF).
- If an input phase is lost while "1" is set in Pr.872 (with input phase loss protection), and **Pr.261 Power failure stop selection** ≠ "0" (power failure stop function enabled), the motor decelerates to stop without outputting the input phase loss protection (E.ILF).
- If an input phase loss continues for a long time, the lives of converter section and capacitor of the inverter become shorter.

Parameters referred to

Pr.261 Power failure stop selection [page 160](#)

5.6.6 Retry function

This function allows the inverter to reset itself and restart at activation of the protective function (fault indication). The retry generating protective functions can also be selected.

When the automatic restart after instantaneous power failure function is selected (**Pr.57 Restart coasting time** ≠ 9999), the restart operation is also performed after a retry operation as well as after an instantaneous power failure. (For restart operation, refer to [page 159](#).)

Pr.	Name	Initial value	Setting range	Description
65 H300	Retry selection	0	0 to 5	A fault for retry can be selected.
67 H301	Number of retries at fault occurrence	0	0	No retry operation
			1 to 10	Set the number of retries at a fault occurrence. A fault output is not provided during the retry operation.
			101 to 110	Set the number of retries at a fault occurrence. (The setting value minus 100 is the number of retries.) A fault output is provided during the retry operation.
68 H302	Retry waiting time	1 s	0.1 to 600 s	Set the waiting time from a fault occurrence to a retry.
69 H303	Retry count display erase	0	0	Clear the number of restarts succeeded by retries.

◆ Setting the retry function (Pr.67, Pr.68)

- When the inverter protective function is operating (fault indication), the retry function automatically cancels (resets) the protective function after the time set in Pr.68. The retry function then restarts the operation from the starting frequency.
- Retry operation is performed when Pr.67 ≠ "0". Set the number of retries at activation of the protective function in Pr.67.

Pr.67 setting	Fault output during retry operation	Retry count
0	—	No retry function
1 to 10	Not available	1 to 10 times
101 to 110	Available	1 to 10 times

- When retries fail consecutively for more than the number of times set in Pr.67, a retry count excess (E.RET) occurs, and the inverter output is shut off. (Refer to the Retry failure example.)
- Use Pr.68 to set the waiting time from a protective function activation to a retry in the range of 0.1 to 600 seconds.
- During retry operation, the During retry (Y64) signal is ON. For the Y64 signal, set "64 (positive logic)" or "164 (negative logic)" in Pr.195 (Output terminal function selection) to assign the function.

◆ Retry count check (Pr.69)

- Reading the Pr.69 value provides the cumulative number of successful restart times made by retries. The retry counter (Pr.69 value) is incremented by 1 every time a retry is successful. Retry is regarded as successful when normal operation restarts and continues with no other faults within the time set in Pr.68 multiplied by four (3.1 seconds at least.) (When retry is successful, the cumulative number of retry failures is cleared.)
- Writing "0" in Pr.69 clears the cumulative count.

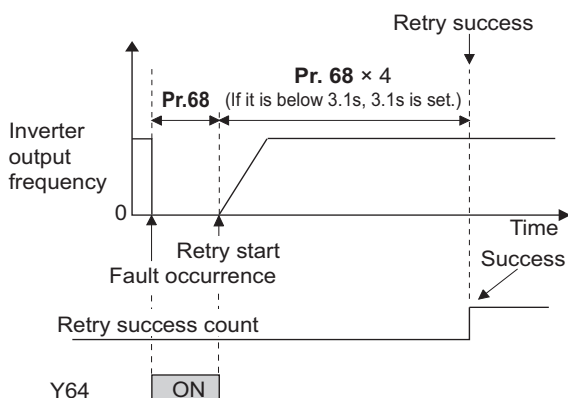

Retry success example

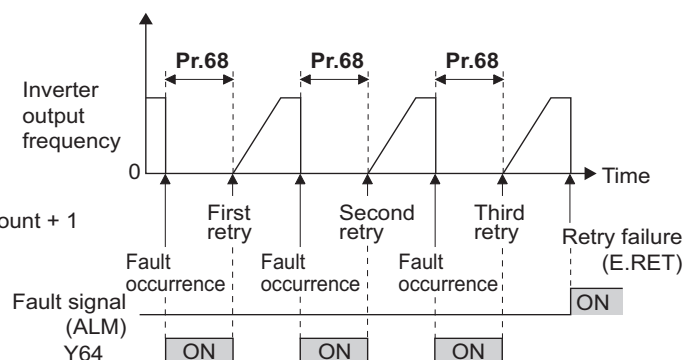

Retry failure example

◆ Selecting retry generating faults (Pr.65)

- Using Pr.65, the fault that causes a retry is selectable. No retry is made for the fault not indicated. (For the fault details, refer to [page 211](#).) • indicates the faults selected for retry.

Retry-making fault	Pr.65 setting					
	0	1	2	3	4	5
E.OC1	•	•		•	•	•
E.OC2	•	•		•	•	
E.OC3	•	•		•	•	•
E.OV1	•		•	•	•	
E.OV2	•		•	•	•	
E.OV3	•		•	•	•	
E.THM	•					
E.THT	•					

Retry-making fault	Pr.65 setting					
	0	1	2	3	4	5
E. GF	•				•	
E. 10	•				•	
E.ILF	•				•	
E.OHT	•					
E.OLT	•				•	
E. PE	•				•	
E.CDO	•				•	
E.LCI	•				•	

NOTE

- Use the retry function only when the operation can be resumed after resetting a protective function activation. Making a retry against the protective function, which is activated by an unknown condition, will lead the inverter and motor to be faulty. Identify and remove the cause of the protective function activation before restarting the operation.
- If the retry function operates during PU operations, the operating conditions (forward/reverse rotation) are stored, and operations resume after retry reset.
- Only the fault details for the first fault that occurred during retry are stored in the fault history.
- When the parameter storage device fault (E.PE) is occurring and reading of the retry-function-related parameters is not possible, retry cannot be operated.
- Changing the terminal assignment using **Pr.195 (Output terminal function selection)** may affect the other functions. Set parameters after confirming the function of each terminal.

Parameters referred to

Pr.57 Restart coasting time [page 159](#)

5.6.7 Limiting the output frequency (maximum/minimum frequency)

Motor speed can be limited. Clamp the upper and lower limits of the output frequency.

Pr.	Name	Initial value	Setting range	Description
1 H400	Maximum frequency	120 Hz	0 to 120 Hz	Set the upper limit of the output frequency.
2 H401	Minimum frequency	0 Hz	0 to 120 Hz	Set the lower limit of the output frequency.
18 H402	High speed maximum frequency	120 Hz	120 to 400 Hz	Set when operating at 120 Hz or higher.

◆ Set the maximum frequency

- Use Pr.1 Maximum frequency to set the maximum output frequency. If the value of the frequency command given is higher than the Pr.1 setting, the output frequency is clamped at the maximum frequency (does not exceed the Pr.1 setting).

- To operate at a frequency higher than the 120 Hz, adjust the upper output frequency limit with Pr.18 High speed maximum frequency. (When a frequency is set in Pr.18, the Pr.1 setting automatically changes to the frequency set in Pr.18. Also, when a frequency is set in Pr.1, the Pr.18 setting automatically changes to the frequency set in Pr.1.)

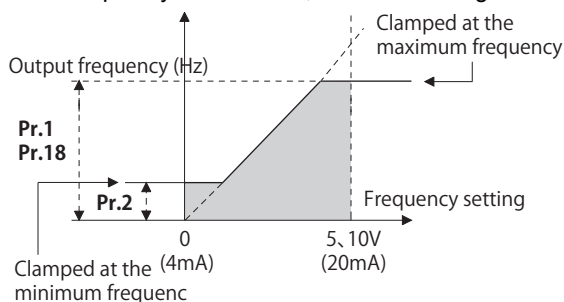

◆ Set minimum frequency (Pr.2)

- Use Pr.2 Minimum frequency to set the minimum output frequency.
- If the value of the frequency command given is lower than the Pr.2 setting, the output frequency is clamped at the minimum frequency (does not fall below the Pr.2 setting).

NOTE

- To operate with a frequency higher than 60 Hz using frequency-setting analog signals, change the Pr.125 (Pr.126) (frequency setting gain) setting. Simply changing the Pr.1 and Pr.18 settings does not enable the operation at a frequency higher than 60 Hz.
- When Pr.15 Jog frequency is less than Pr.2, the Pr.15 setting takes precedence.
- If a jump frequency that exceeds Pr.1 (Pr.18) is set for the frequency jump, the maximum frequency setting is the set frequency. If the jump frequency is less than the setting of Pr.2, the jump frequency is the set frequency. (The set frequency can be equal to or lower than the minimum frequency.) When stall prevention is activated to decrease the output frequency, the output frequency may drop to Pr.2 or below.

CAUTION

- Note that when Pr.2 is set to any value equal to or higher than the Pr.13 Starting frequency setting, simply turning ON the start signal runs the motor at the frequency set in Pr.2 even if the command frequency is not given.

Parameters referred to

Pr.13 Starting frequency [page 99](#)

Pr.15 Jog frequency [page 108](#)

Pr.125 Terminal 2 frequency setting gain frequency, Pr.126 Terminal 4 frequency setting gain frequency [page 134](#)

5.6.8 Avoiding machine resonance points (frequency jump)

When it is desired to avoid resonance attributable to the natural frequency of a mechanical system, these parameters allow resonant frequencies to be jumped.

Pr.	Name	Initial value	Setting range	Description
31 H420	Frequency jump 1A	9999	0 to 400 Hz, 9999	The frequencies are changed in the ranges of 1A to 1B, 2A to 2B, and 3A to 3B. 9999: Function disabled
32 H421	Frequency jump 1B			
33 H422	Frequency jump 2A			
34 H423	Frequency jump 2B			
35 H424	Frequency jump 3A			
36 H425	Frequency jump 3B			

◆ Frequency jump (Pr.31 to Pr.36)

- Up to three areas may be set, with the jump frequencies set to either the top or bottom point of each area.
- The settings of frequency jumps 1A, 2A, and 3A are the jump points, and operation is performed at these frequencies in the jump areas.

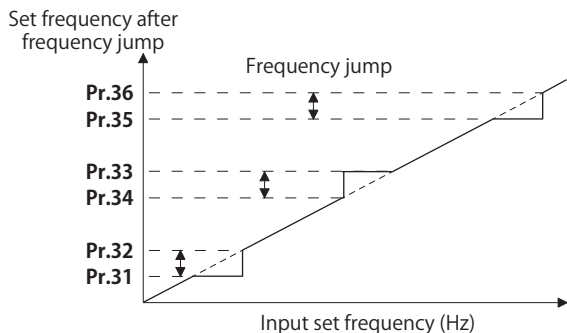

Example 1) To fix the frequency to 30 Hz in the range of 30 Hz to 35 Hz, set 35 Hz in **Pr.34** and 30 Hz in **Pr.33**.

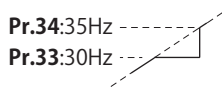

Example 2) To change the frequency to 35 Hz in the range of 30 Hz to 35 Hz, set 35 Hz in **Pr.33** and 30 Hz in **Pr.34**.

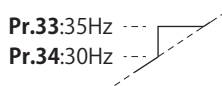

◀ Parameters referred to ▶

Pr.1 Maximum frequency, Pr.2 Minimum frequency, Pr.18 High speed maximum frequency [page 117](#)

5.6.9 Stall prevention operation

This function monitors the output current and automatically changes the output frequency to prevent the inverter from shutting off due to overcurrent, overvoltage, etc. It can also limit the stall prevention and fast-response current limit operation during acceleration/deceleration and power/regenerative driving.

- Stall prevention: If the output current exceeds the stall prevention operation level, the output frequency of the inverter is automatically changed to reduce the output current.
- Fast-response current limit: If the current exceeds the limit value, the output of the inverter is shut off to prevent an overcurrent.

Pr.	Name	Initial value	Setting range	Description
22 H500	Stall prevention operation level	150%	0	Stall prevention operation disabled.
			0.1 to 200%	Set the current limit at which the stall prevention operation starts.
156 H501	Stall prevention operation selection	0	0 to 31, 100, 101	Enable/disable the stall prevention operation and the fast-response current limit operation.
23 H610	Stall prevention operation level compensation factor at double speed	9999	0 to 200%	The stall operation level can be reduced for operation at the rated frequency or higher.
			9999	Stall prevention operation disabled at double speed.
66 H611	Stall prevention operation reduction starting frequency	50 Hz	0 to 400 Hz	Set the frequency at which the stall operation level reduction starts.
157 M430	OL signal output timer	0 s	0 to 25 s	Set the OL signal output start time when stall prevention is activated.
			9999	No OL signal output.

◆ Setting of stall prevention operation level (Pr.22)

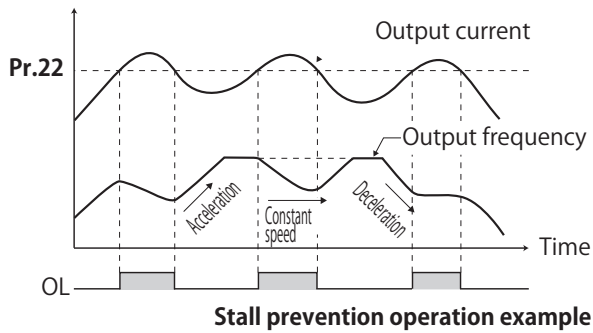

- For **Pr.22 Stall prevention operation level**, set the ratio of the output current to the inverter rated current at which the stall prevention operation is activated. Normally, this should be set at 150% (initial value).
- Stall prevention operation stops acceleration (makes deceleration) during acceleration, makes deceleration during constant speed, and stops deceleration during deceleration.
- When the stall prevention operation is performed, the Overload warning (OL) signal is output.

NOTE

- A continuous overloaded condition may activate a protective function such as motor overload trip (electronic thermal O/L relay function) (E.THM).
- When Pr.156 is set to activate the fast-response current limit (initial value), the **Pr.22** setting should not exceed 170%. Otherwise, the torque may be insufficient.

◆ Disabling the stall prevention operation and fast-response current limit according to operating conditions (Pr.156)

- Referring to the following table, enable/disable the stall prevention operation and the fast-response current limit operation, and also set the operation at OL signal output.

Pr.156 setting	Fast-response current limit ○: enabled ●: disabled	Stall prevention operation selection ○: enabled ●: disabled			OL signal output ○: enabled ●: disabled ^{*1}
		Acceleration	Constant speed	Deceleration	
0 (initial value)	○	○	○	○	○
1	●	○	○	○	○
2	○	●	○	○	○
3	●	●	○	○	○
4	○	○	●	○	○
5	●	○	●	○	○
6	○	●	●	○	○
7	●	●	●	○	○
8	○	○	○	●	○
9	●	○	○	●	○
10	○	●	○	●	○
11	●	●	○	●	○
12	○	○	●	●	○
13	●	○	●	●	○
14	○	●	●	●	○
15	●	●	●	●	— ^{*2}
16	○	○	○	○	●
17	●	○	○	○	●
18	○	●	○	○	●
19	●	●	○	○	●
20	○	○	●	○	●
21	●	○	●	○	●
22	○	●	●	○	●
23	●	●	●	○	●
24	○	○	○	●	●
25	●	○	○	●	●
26	○	●	○	●	●
27	●	●	○	●	●
28	○	○	●	●	●
29	●	○	●	●	●
30	○	●	●	●	●
31	●	●	●	●	— ^{*2}
100 ^{*3}	Power driving	○	○	○	○
	Regenerative driving	●	●	●	— ^{*2}
101 ^{*3}	Power driving	●	○	○	○
	Regenerative driving	●	●	●	— ^{*2}

*1 When "operation stop at OL signal output" is selected, the fault output "*E.o.l.f*" (stop due to stall prevention) is displayed, and operation stops.

*2 The OL signal or E.O.L.T is not outputted because fast-response current limit and stall prevention are not operating.

*3 Setting values "100, 101" can be individually set for power driving and regenerative driving. The setting value "101" disables the fast-response current limit during power driving.

NOTE

- When the load is heavy or the acceleration/deceleration time is short, stall prevention operates and acceleration/deceleration may not be performed according to the time set. Set the **Pr.156** and stall prevention operation level to the optimum values.
- For lift applications, make settings to disable the fast-response current limit. Otherwise, the torque may be insufficient, causing the load to drop.

◆ Adjusting the stall prevention operation signal and output timing (OL signal, Pr.157)

- If the output current exceeds the stall prevention operation level and stall prevention is activated, the Overload warning (OL) signal turns ON for 100 ms or more. The output signal turns OFF when the output current falls to the stall prevention operation level or less.
- **Pr.157 OL signal output timer** can be used to set whether to output the OL signal immediately, or to output it after a certain time period.
- This function also operates during regeneration avoidance operation ("OLU" overvoltage stall).

Pr.157 setting	Description
0 (initial value)	Output immediately.
0.1 to 25	Output after the set time (s).
9999	Not output.

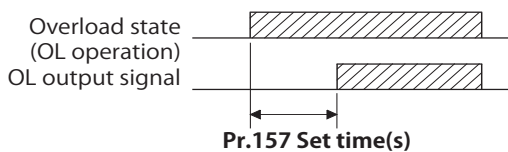

NOTE

- For the OL signal, set "3 (positive logic)" or "103 (negative logic)" in **Pr.195 (Output terminal function selection)** to assign the function.
- If the stall prevention operation lowers the output frequency to 0.5 Hz and kept the level for 3 seconds, the stall prevention stop (E.OLT) is activated to shut off the inverter output.
- Changing the terminal assignment using **Pr.195 (Output terminal function selection)** may affect the other functions. Set parameters after confirming the function of each terminal.

◆ Setting for stall prevention operation in the high-frequency range (Pr.22, Pr.23, Pr.66)

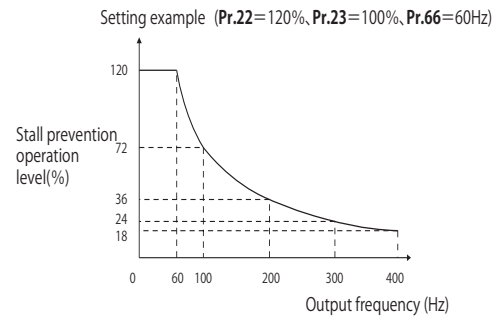
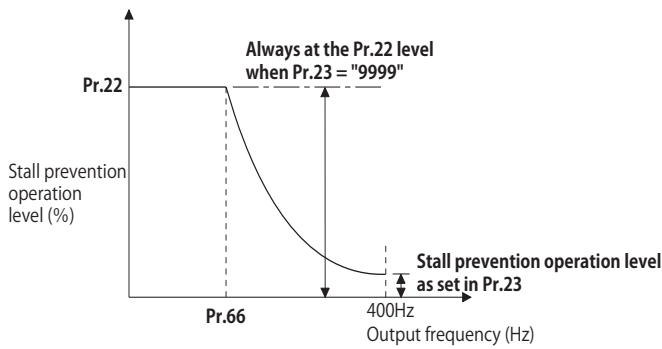

- When operating at the rated motor frequency or higher, acceleration may not be made as the motor current does not increase. Also, when operating in the high-frequency range, the current flowing to the locked motor becomes less than the rated output current of the inverter. Even if the motor is stopped, the protective function does not operate (OL). In a case like this, the stall prevention level can be reduced in the high-frequency range to improve the motor's operating characteristics. This is useful when operating up to the high speed range, such as when using a centrifuge. Normally, set **Pr.66 Stall prevention operation reduction starting frequency** to 60 Hz, and **Pr.23 Stall prevention operation level compensation factor at double speed** to 100%.
- Calculation formula for stall prevention operation level

$$\text{Stall prevention operation level (\%)} \text{ in the high-frequency range} = A + B \times \left[\frac{\text{Pr.22} - A}{\text{Pr.22} - B} \right] \times \left[\frac{\text{Pr.23} - 100}{-100} \right]$$
 Where, $A = \frac{\text{Pr.66 (Hz)} \times \text{Pr.22 (\%)}}{\text{Output frequency (Hz)}}$, $B = \frac{\text{Pr.66 (Hz)} \times \text{Pr.22 (\%)}}{400\text{Hz}}$
- When Pr.23 = "9999" (initial value), the stall prevention operation level is constant at the Pr.22 level up to 400 Hz.

Parameters referred to

Pr.195 (Output terminal function selection) [page 126](#)

5.7 (M) Item and output signal for monitoring

Purpose	Parameter to set		Refer to page
To change the item monitored on the operation panel and parameter unit	Operation panel monitor item selection, Cumulative monitor value clear	P.M020, P.M030, P.M100 to P.M103	Pr.170, Pr.171, Pr.774 to Pr.776 124
To assign functions to the output terminals	Output terminal function assignment	P.M405	Pr.195 126
To detect the output frequency	Up-to-frequency sensitivity Output frequency detection Low speed detection	P.M440 to P.M443	Pr.41 to Pr.43 129
To detect the output current	Output current detection	P.M460, P.M461, P.M464	Pr.150, Pr.151, Pr.167 129

5.7.1 Monitor item selection on operation panel or via communication

The monitor item to be displayed on the operation panel or the parameter unit can be selected.

Pr.	Name	Initial value	Setting range	Description
774 M101	Operation panel monitor selection 1	1	1 to 3, 5, 8, 10, 14, 20, 23 to 25, 52 to 55, 61, 62, 100	Each of the initial items monitored on the operation panel or parameter unit in the monitor mode (output frequency, output current, and output voltage) can be switched to an user-designated item.
775 M102	Operation panel monitor selection 2	2		
776 M103	Operation panel monitor selection 3	3		
170 M020	Watt-hour meter clear	9999	0	Set "0" to clear the watt-hour meter.
			10	Set "10" to monitor the cumulative power in the range of 0 to 9999 kWh via communication.
			9999	Set "9999" to monitor the cumulative power in the range of 0 to 65535 kWh via communication.
171 M030	Operation hour meter clear	9999	0	Set "0" to clear the operation hour meter.
			9999	The readout is always 9999. Nothing changes when "9999" is set.

◆ Monitor item list (Pr.774 to Pr.776)

- Use Pr.774 to Pr.776 to select items to monitor on the PU.
- Refer to the following table to find the setting value for each monitoring. (The items marked with "—" cannot be selected. The circle in the [-] column indicates that the indication of negative signed numbers is available.)

Monitor item	Increment and unit	PU monitor Pr.774 to Pr.776	RS-485 communication dedicated monitor (hexadecimal)	MODBUS RTU real time monitor	Description
Output frequency (speed) ^{*7}	0.01 Hz	1/100	H01	40201	The inverter output frequency is displayed.
Output current ^{*4*7}	0.01 A	2	H02	40202	The inverter output current effective value is displayed.
Output voltage ^{*7}	0.1 V	3	H03	40203	The inverter output voltage is displayed.
Fault indication	—	—	—	—	Each of the last 8 faults is displayed individually.
Set frequency / motor speed setting	0.01 Hz	5	H05	40205	The set frequency is displayed.
Converter output voltage	0.1 V	8	H08	40208	The DC bus voltage value is displayed.
Electronic thermal O/L relay load factor	0.1%	10	H0A	40210	The motor thermal cumulative value is displayed, considering the thermal operation level as 100%.

Monitor item	Increment and unit	PU monitor Pr.774 to Pr.776	RS-485 communication dedicated monitor (hexadecimal)	MODBUS RTU real time monitor	Description
Output power ^{*4}	0.01 kW	14	H0E	40214	The power at the inverter output side is displayed.
Cumulative energization time ^{*1}	1 h	20	H14	40220	The cumulative energization time since the inverter shipment is displayed.
Actual operation time ^{*1*2}	1 h	23	H17	40223	The cumulative operation time is displayed.
Motor load factor	0.1%	24	H18	40224	The output current value is displayed as a percentage, considering the inverter rated current value as 100%. Readout (%) = present output current value / inverter rated current value × 100
Cumulative energy	0.01 kWh ^{*3}	25	H19	40225	The cumulative energy based on the monitored output power is displayed. Use Pr.170 to reset it.
PID set point	0.1%	52	H34	40252	The set point, measured value, or deviation during PID control operation is displayed. (Refer to page 156.)
PID measured value	0.1%	53	H35	40253	
PID deviation	0.1%	54	H36	40254	
Input terminal status	—	55 ^{*8}	H0F ^{*5}	40215 ^{*5}	The ON/OFF state of the input terminals on the inverter is displayed.
Output terminal status	—		H10 ^{*6}	40216 ^{*6}	The ON/OFF state of the output terminals on the inverter is displayed.
Motor thermal load factor	0.1%	61	H3D	40261	The accumulated heat value of the motor thermal O/L relay is displayed. The motor overload trip (electronic thermal O/L relay function) (E.THM) occurs at 100%.
Inverter thermal load factor	0.1%	62	H3E	40262	The accumulated heat value of the inverter thermal O/L relay is displayed. The inverter overload trip (electronic thermal O/L relay function) (E.THT) occurs at 100%.

*1 The cumulative energization time and actual operation time are accumulated from 0 to 65535 hours, then cleared, and accumulated again from 0.

*2 The actual operation time does not increase if the cumulative running time before power OFF is less than an hour.

*3 On the parameter unit (FR-PU07), "kW" is displayed

*4 The output current is regarded as 0 A when the current is less than the specified level (5% of the rated inverter current). Therefore, each readout of an output current and output power may show "0" if a too small-capacity motor is used as contrasted with the inverter capacity and the output current falls below the specified value.

*5 The details of bits for the input terminal status are as follows. (1: ON state, 0: OFF state of a terminal on the inverter. "—" denotes an indefinite (null) value.)

b15													b0			
-	-	-	-	-	-	-	-	-	-	RH	RM	RL	-	-	STR	STF

*6 The details of bits for the output terminal status are as follows. (1: ON state, 0: OFF state of a terminal on the inverter. "—" denotes an indefinite (null) value.)

b15													b0			
-	-	-	-	-	-	-	-	-	-	-	ABC	-	-	-	-	-

*7 The monitored values are retained even if an inverter fault occurs. Resetting clears the retained values.

*8 Parameter setting is not available for setting the item as the main monitor item on the LCD operation panel (FR-LU08) or the parameter unit (FR-PU07). Use the monitor function of the FR-LU08 or the FR-PU07 for setting.

◆ Monitor display for operation panel (Pr.774 to Pr.776)

- The monitor item to be displayed is set using Pr.774 for the first screen, Pr.775 for the second screen, and Pr.776 for the third screen.

NOTE

- On the operation panel, the "Hz" unit indicator is lit while displaying the output frequency, the "Hz" blinks when displaying the set frequency.

◆ Monitoring I/O terminals on the operation panel (Pr.774 to Pr.776)

- When Pr.774 to Pr.776 = "55", the I/O terminal state can be monitored on the operation panel.

- The LED is ON when the terminal is ON, and the LED is OFF when the terminal is OFF. The center line of LED is always ON. The center line of LED is always ON.

Pr.774 to Pr.776 setting	Monitor item	Monitor description
55	I/O terminal status	Displays the I/O terminal ON/OFF state of the inverter.

- On the I/O terminal monitor, the upper LEDs indicate the input terminal status, and the lower LEDs indicate the output terminal status.

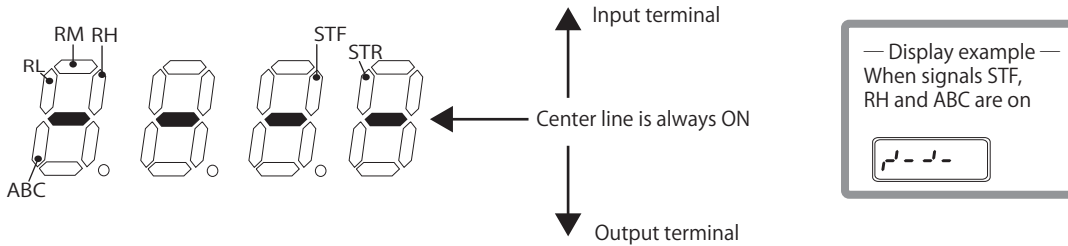

5.7.2 Output terminal function selection

Use the following parameters to change the functions assigned to relay output terminals.

Pr.	Name	Initial value	Signal name	Setting range
190 M400	NET Y0 terminal function selection	0	NET Y0 (Inverter running)	0, 1, 3, 4, 8, 11, 12, 14 to 16, 26, 46, 47, 64, 70, 91, 98, 99, 100, 101, 103, 104, 108, 111, 112, 114 to 116, 126, 146, 147, 164, 170, 191, 198, 199, 9999
191 M401	NET Y1 terminal function selection	1	NET Y1 (Up to frequency)	
192 M402	NET Y2 terminal function selection	3	NET Y3 (Overload warning)	
193 M403	NET Y3 terminal function selection	9999	No function	
194 M404	NET Y4 terminal function selection	4	NET Y4 (Output frequency detection)	
195 M405	ABC terminal function selection	99	ALM (Fault)	

◆ Output signal list

- A function listed below can be set to each output terminal.
- Refer to the following table and set the parameters. (0 to 99: Positive logic, 100 to 199: Negative logic)

Setting		Signal name	Function	Operation	Related parameter	Refer to page
Positive logic	Negative logic					
0	100	RUN	Inverter running	Outputted during operation when the inverter output frequency reaches Pr.13 Starting frequency or higher.	—	127
1	101	SU	Up to frequency ^{*1}	Outputted when the output frequency reaches the set frequency.	Pr.41	129
3	103	OL	Overload warning	Outputted while the stall prevention function works.	Pr.22, Pr.23, Pr.66	119
4	104	FU	Output frequency detection	Outputted when the output frequency reaches the frequency set in Pr.42 (Pr.43 during reverse rotation) or higher.	Pr.42, Pr.43	129
8	108	THP	Electronic thermal O/L relay pre-alarm	Outputted when the cumulative electronic thermal O/L relay value reaches 85% of the trip level. (Electronic thermal O/L relay protection (E.THT/E.THM) is activated when the value reaches 100%.)	Pr.9	112
11	111	RY	Inverter operation ready	Outputted when the reset process is completed after powering ON the inverter or when the inverter is ready to start operation with the start signal ON or during operation.	—	127

Setting		Signal name	Function	Operation	Related parameter	Refer to page
Positive logic	Negative logic					
12	112	Y12	Output current detection	Outputted when the output current is higher than the Pr.150 setting for the time set in Pr.151 or longer.	Pr.150, Pr.151	129
14	114	FDN	PID lower limit	Outputted when the input value is lower than the lower limit set for the PID control operation.	Pr.127 to Pr.134, Pr.575 to Pr.577	152
15	115	FUP	PID upper limit	Outputted when the input value is higher than the upper limit set for the PID control operation.		
16	116	RL	PID forward/reverse rotation output	Outputted during forward rotation operation in the PID control operation.		
26	126	FIN	Heatsink overheat pre-alarm	Outputted when the heat sink temperature rises to 85% of temperature at which the protective function of the heatsink overheat is activated.	—	216
46	146	Y46	During deceleration at occurrence of power failure	Outputted when the power-failure deceleration function is activated. (The signal output is retained until the function stops.)	Pr.261	160
47	147	PID	During PID control activated	Outputted during the PID control operation.	Pr.127 to Pr.134, Pr.575 to Pr.577	152
64	164	Y64	During retry	Outputted during retry operation.	Pr.65 to Pr.69	115
70	170	SLEEP	PID output interruption	Outputted while PID output suspension function is activated.	Pr.127 to Pr.134, Pr.575 to Pr.577	152
91	191	Y91	Fault output 3 (power-OFF signal)	Outputted when the Fault occurs due to an inverter circuit fault or connection fault.	—	128
98	198	LF	Alarm	Output when an alarm (fan alarm or communication error warning) occurs.	Pr.121	165
99	199	ALM	Fault	Outputted when the inverter's protective function is activated to stop the power output (when the Fault occurs). The signal output stops when the inverter reset starts.	—	128
9999		—	No function	—	—	—

*1 Note that changing the frequency setting with an analog signal or the UP/DOWN keys on the operation panel may turn ON and OFF the Up to frequency (SU) signal alternately. This condition occurs depending on the speed and the timing of the speed change determined by the acceleration/deceleration time setting. (The signal state changing does not occur when the acceleration/deceleration time is set to 0 seconds.)

NOTE

- One function can be assigned to more than one terminal.
- The terminal becomes conductive when the function is activated by setting any of "0 to 99" in the parameter, while the terminal becomes non-conductive when the function is activated by setting any of "100 to 199".
- Changing the terminal assignment using **Pr.190 to Pr.195 (Output terminal function selection)** may affect the other functions. Set parameters after confirming the function of each terminal.
- Do not assign the signal to terminals A, B, and C which frequently changes its state between ON and OFF. Otherwise, the life of the relay contact may be shortened.

◆ Inverter operation ready?(RY) signal and Inverter running (RUN) signal

■ Operation under V/F control and General-purpose magnetic flux vector control

- When the inverter is ready to operate, the Inverter operation ready (RY) signal turns ON (and stays ON during operation).

- When the inverter output frequency reaches the **Pr.13 Starting frequency** setting or higher, the Inverter running (RUN) signal turns ON. The signals are OFF while the inverter is stopped or during the DC injection brake operation.

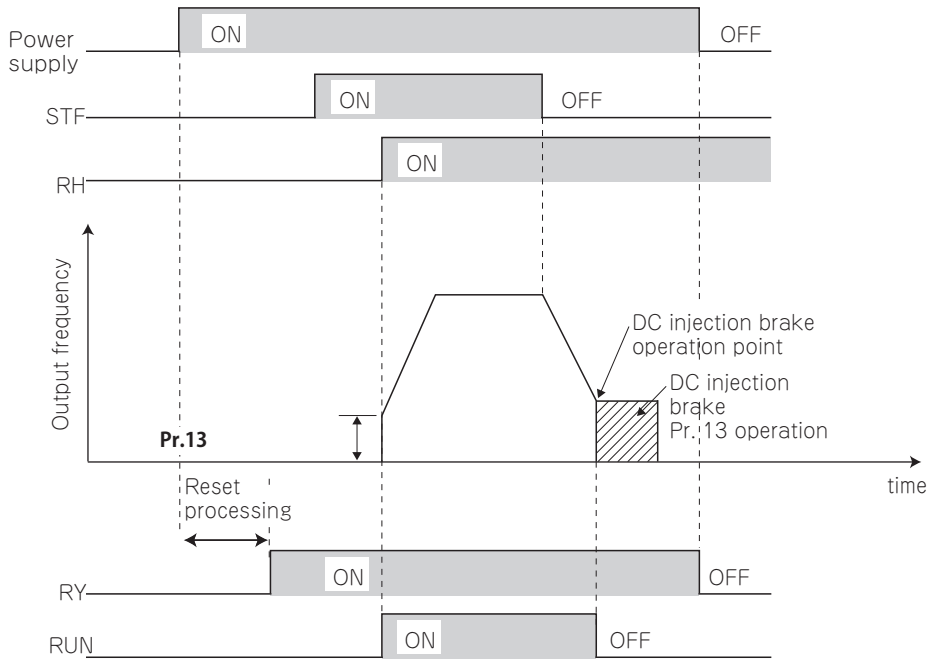

- The ON/OFF state of each signal according to the inverter operating status is shown in the matrix below.

Output signal	Start signal OFF (inverter stopped)	Start signal ON (inverter stopped)	Start signal ON (inverter running)	During DC injection brake operation	Inverter output shutoff*2	Automatic restart after instantaneous power failure		
						During coasting		Inverter running after restart
						Start signal ON	Start signal OFF	
RY	ON	ON	ON	ON	OFF	ON*1		ON
RUN	OFF	OFF	ON	OFF	OFF	OFF		ON

*1 The signal is OFF during power failure or undervoltage.

*2 This means the state during a fault occurrence or while the MRS signal is ON, etc.

◆ Fault (ALM) signal

- The Fault (ALM) signal is output when an inverter protective function is activated.

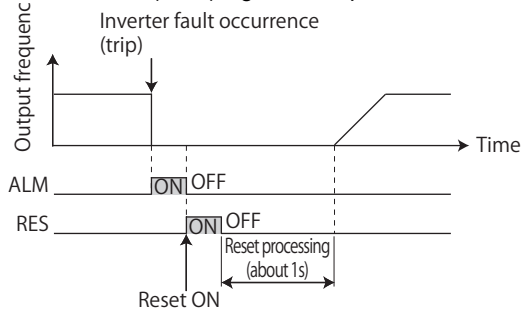

◆ Input MC shutoff (Y91) signal

- The Fault output 3 (Y91) signal is output when a fault originating in the inverter circuit or a connection fault occurs.
- To use the Y91 signal, set "91 (positive logic) or 191 (negative logic)" in Pr.195 (Output terminal function selection) to assign the function to the output terminal.

- The following is the list of faults that output the Y91 signal. (For the fault details, refer to [page 211](#).)

Fault record
Inrush current limit circuit fault (E.IOH)
CPU fault (E.CPU)
Parameter storage device fault (E.PE)
Parameter storage device fault (E.PE2)
Output side earth (ground) fault overcurrent (E.GF)
Output phase loss (E.LF)

«Parameters referred to»

Pr.13 Starting frequency [page 99](#)

5.7.3 Output frequency detection

If the inverter output frequency which reaches a specific value is detected, the relative signal is output.

Pr.	Name	Initial value	Setting range	Description
41 M441	Up-to-frequency sensitivity	10%	0 to 100%	Set the level where the SU signal turns ON.
42 M442	Output frequency detection	6 Hz	0 to 400 Hz	Set the frequency at which the FU signal turns ON.
43 M443	Output frequency detection for reverse rotation	9999	0 to 400 Hz	Set the frequency at which the FU signal turns ON only while the motor rotates in reverse direction.
			9999	Same as the Pr.42 setting.

◆ Setting the notification zone of the output frequency reaching the set point (SU signal, Pr.41)

- The Up to frequency (SU) signal is output when the output frequency reaches the set frequency.
- The Pr.41 value can be adjusted within the range $\pm 1\%$ to $\pm 100\%$ considering the set frequency as 100%.
- It may be useful to use this signal to start operating related equipment after checking that the set frequency has been reached.

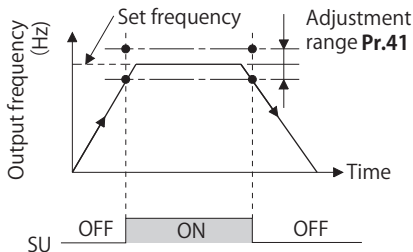

«Parameters referred to»

Pr.195 (Output terminal function selection) [page 126](#)

5.7.4 Output current detection function

If the inverter output current which reaches a specific value is detected during operation, the relative signal is output via an output terminal.

Pr.	Name	Initial value	Setting range	Description
150 M460	Output current detection level	150%	0 to 400%	Set the output current detection level. Consider the value of the rated inverter current as 100%.
151 M461	Output current detection signal delay time	0 s	0 to 10 s	Set the output current detection time. Enter the delay time between the time when the output current reaches the set current or higher and the time when the Output current detection (Y12) signal is output.
167 M464	Output current detection operation selection	0	0, 1	Select the inverter operation at the time when the Y12 signal turns ON.

◆ Output current detection (Y12 signal, Pr.150, Pr.151, Pr.167)

- The output current detection function is useful for overtorque detection.

- If the inverter output during inverter running remains higher than the **Pr.150** setting for the time set in **Pr.151** or longer, the Output current detection (Y12) signal is output from the inverter's open collector or the relay output terminal.
- Setting **Pr.167** = "1" while the Y12 signal is ON does not cause the fault E.CDO. The **Pr.167** setting becomes valid after the Y12 signal is turned OFF.
- For the Y12 signal, set "12 (positive logic) or 112 (negative logic)" in **Pr.195 (Output terminal function selection)** to assign the function to the output terminal.
- Use **Pr.167** to select the inverter operation at the time when Y12 signal turns ON, whether to stop the output or to continue the operation.

Pr.167 setting	When the Y12 signal turns ON
0 (initial value)	Operation continues.
1	Operation stops by fault (E.CDO).

Pr.167=0

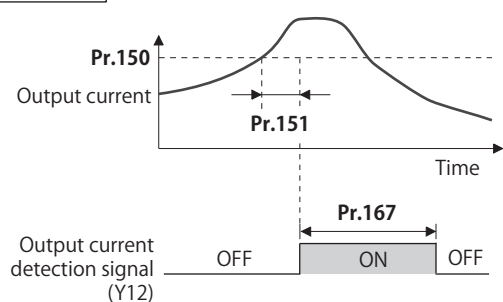

« Parameters referred to »

Offline auto tuning [page 147](#)

Pr.195 (Output terminal function selection) [page 126](#)

5.8 (T) Multi-function input terminal parameters

Purpose	Parameter to set			Refer to page
To inverse the rotation direction with the voltage/current analog input selection (terminals 2 and 4)	Analog input selection	P.T000, P.T001	Pr.73, Pr.267	131
To eliminate noise on analog inputs	Analog input filter	P.T002	Pr.74	134
To adjust analog input frequency/voltage (current) (calibration)	Frequency setting voltage (current) bias and gain	P.T200 to P.T203, P.T400 to P.T403	Pr.125, Pr.126, C2 to C7 (Pr.902 to Pr.905)	134
To continue operating at analog current input loss	4 mA input check	P.A680, P.T054	Pr.573, Pr.778	139
To assign functions to input terminals	Input terminal function selection	P.T700 to P.T704	Pr.178 to Pr.182	142
To change the input specification (NO/NC contact) of input signals	Output stop signal (MRS) input selection	P.T720	Pr.17	143
To assign start and forward/reverse commands to different signals	Start signal (STF/STR) operation selection	P.G106	Pr.250	145

5

5.8.1 Analog input selection

The functions to switch the analog input terminal specifications, override function, forward/reverse rotation by the input signal polarity are selectable.

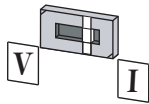
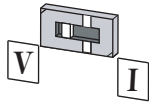
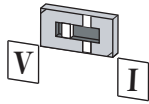
Pr.	Name	Initial value	Setting range	Description	
73 T000	Analog input selection	1	0	Terminal 2 input, 0 to 10 V	The reversible operation is disabled.
			1	Terminal 2 input, 0 to 5 V	
			10	Terminal 2 input, 0 to 10 V	The reversible operation is enabled.
			11	Terminal 2 input, 0 to 5 V	
267 T001	Terminal 4 input selection	0	Voltage/current input switch		Description
			0		Terminal 4 input, 4 to 20 mA
			1		Terminal 4 input, 0 to 5 V
			2		Terminal 4 input, 0 to 10 V

◆ Analog input specification selection

- For terminal 4 used for analog input, the voltage input (0 to 5 V, 0 to 10 V) and current input (0 to 20 mA) are selectable. To change the input specification, change the setting of **Pr.73 (Pr.267)** and the voltage/current input selection switch.

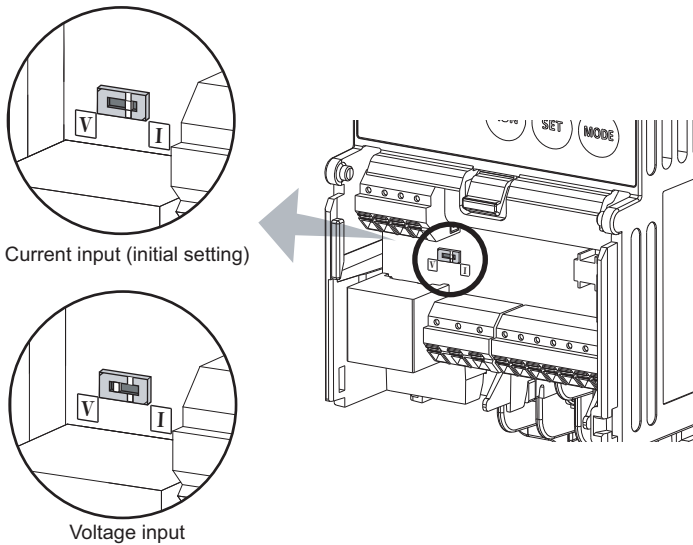

Switch state		Input specification	Input terminal	Rated specification
Switch	I	Current input (initial status)	Terminal 4	For voltage input, the input resistance is $10 \pm 1 \text{ k}\Omega$ and the maximum permissible voltage is 20 VDC.
	V	Voltage input		For current input, the input resistance is $249 \Omega (\pm 5 \Omega)$ and the maximum permissible current is 30 mA.

- Change the setting of the voltage/current input selection switch to change the rated specification of terminal 4.
- Set **Pr.73 (Pr.267)** and the voltage/current input selection switch according to the analog signal input. The incorrect settings shown in the following table cause a failure. The inverter does not operate properly with other incorrect settings.

Setting causing a failure		Operation
Switch setting	Terminal input	
I (Current input)	Voltage input	Causes an analog signal output circuit failure in an external device (due to increased loads on the signal output circuit of the external device).
V (Voltage input)	Current input	Causes an input circuit failure in the inverter (due to an increased output power in the analog signal output circuit of an external device).

Set **Pr.73** and the voltage/current input selection switch according to the following table.

Pr.73 setting	Terminal 2 input	Switch 1	Reversible polarity
0	0 to 10 V ^{*1}	OFF	Not applied (state in which a negative polarity frequency command signal is not accepted)
1 (initial value)	0 to 5 V ^{*1}	OFF	
10	0 to 10 V ^{*1}	OFF	Applied
11	0 to 5 V ^{*1}	OFF	

*1 The main speed setting is indicated.

- When the Terminal 4 input selection (AU) signal is turned ON, terminal 4 is used to set the speed. In this case, terminal 2 is not used to set the speed.
- Set **Pr.267** and the voltage/current input selection switch according to the following table.

Pr.267 setting	Terminal 4 input	Switch 2
0 (initial value)	4 to 20 mA	I
1	0 to 5 V	V
2	0 to 10 V	V

NOTE

- To enable terminal 4, turn ON the AU signal.
- Set the parameters and the switch settings so that they agree. Incorrect setting may cause a fault, failure, or malfunction.
- Use Pr.125 (Pr.126) (frequency setting gain) to change the maximum output frequency at the input of the maximum output frequency command voltage (current). At this time, the command voltage (current) need not be input. The acceleration/deceleration time is shown as a slope up/down to the acceleration/deceleration reference frequency. The acceleration/deceleration time is not affected by the change in Pr.73 setting.
- Always calibrate the input after changing the voltage/current input signal with **Pr.73 (Pr.267)** and the voltage/current input selection switch.

◆ Running with analog input voltage

- For the frequency setting signal, input 0 to 5 VDC (or 0 to 10 VDC) between terminals 2 and 5. The 5 V (10 V) input is the maximum output frequency.
- The power supply 5 V (10 V) can be input by either using the internal power supply or preparing an external power supply. The internal power supply is 5 VDC output between terminals 10 and 5.

Terminal	Inverter internal power source voltage	Frequency setting resolution	Pr.73 (terminal 2 input voltage)
10	5 VDC	0.060 Hz / 60 Hz	0 to 5 VDC input

- To supply the 10 VDC input to terminal 2, set "0 or 10" in **Pr.73**. (The initial value is 0 to 5 V.)
- Set "1 (0 to 5 VDC) or 2 (0 to 10 VDC)" in **Pr.267** and turn "V" the voltage/current input selection switch to input voltage through terminal 4. Turning ON the AU signal activates the terminal 4 input.

Use an external power supply.

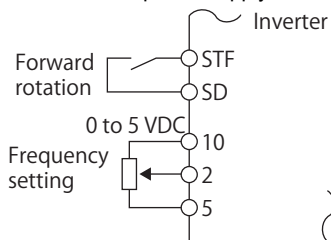

Connection diagram using terminal 2 (0 to 5 VDC)

NOTE

- The wiring length of terminal 10, 2, and 5 should be 30 m at maximum.

◆ Running with analog input current

- For constant pressure or temperature control with fans, pumps, or other devices, automatic operation is available by setting the regulator output signal 4 to 20 mADC to between terminals 4 and 5.
- To use terminal 4, the AU signal needs to be turned ON.

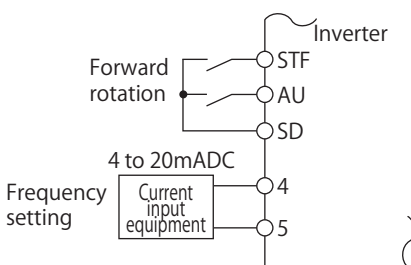

Connection diagram using terminal 4 (4 to 20mADC)

◆ Performing forward/reverse rotation with the analog input (polarity reversible operation)

- Setting "10" in Pr.73 enables the polarity reversible operation.

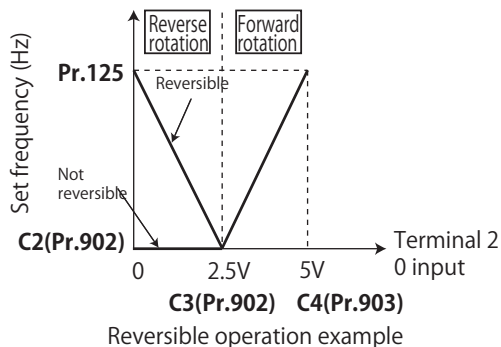

Parameters referred to

Pr.22 Stall prevention operation level [page 119](#)

Pr.125 Terminal 2 frequency setting gain frequency, Pr.126 Terminal 4 frequency setting gain frequency [page 134](#)

5.8.2 Response level of analog input and noise elimination

The response level and stability of frequency command / torque command using the analog input signal (terminal 2 or 4) can be adjusted.

Pr.	Name	Initial value	Setting range	Description
74 T002	Input filter time constant	1	0 to 8	Set the primary delay filter time constant to the analog input command. If the setting is too large, response becomes slow.

◆ Analog input time constant (Pr.74)

- Use this parameter to eliminate noise on the frequency setting circuit.
- Increase the filter time constant if the operation is unstable due to noise or other factors.

If the setting is too large, response becomes slow. (The time constant can be between 0 and 8, which are about 5 ms to 1 s.)

Parameters referred to

Pr.73 Analog input selection [page 131](#)

Pr.125, C2 to C4 (bias and gain of the terminal 2 frequency setting) [page 134](#)

5.8.3 Frequency setting voltage (current) bias and gain

The magnitude (slope) of the output frequency can be set as desired in relation to the frequency setting signal (0 to 5 VDC, 0 to 10 VDC, or 4 to 20 mA).

Use **Pr.73 Analog input selection (Pr.267 Terminal 4 input selection)** and the voltage/current input selection switch to switch among input of 0 to 5 VDC, 0 to 10 V, and 0 to 20 mA. (Refer to [page 131.](#))

Pr.	Name	Initial value	Setting range	Description
C2 (902) T200*1	Terminal 2 frequency setting bias frequency	0 Hz	0 to 400 Hz	Set the bias frequency for the terminal 2 input.
C3 (902) T201*1	Terminal 2 frequency setting bias	0%	0 to 300%	Set the converted % of the bias voltage (current) for the terminal 2 input.
125 (903) T202*1	Terminal 2 frequency setting gain frequency	50 Hz	0 to 400 Hz	Set the gain (maximum) frequency for the terminal 2 input.
C4 (903) T203*1	Terminal 2 frequency setting gain	100%	0 to 300%	Set the converted % of the gain voltage (current) for the terminal 2 input.
C5 (904) T400*1	Terminal 4 frequency setting bias frequency	0 Hz	0 to 400 Hz	Set the bias frequency for the terminal 4 input.
C6 (904) T401*1	Terminal 4 frequency setting bias	20%	0 to 300%	Set the converted % of the bias current (voltage) for the terminal 4 input.
126 (905) T402*1	Terminal 4 frequency setting gain frequency	50 Hz	0 to 400 Hz	Set the gain (maximum) frequency for the terminal 4 input.
C7 (905) T403*1	Terminal 4 frequency setting gain	100%	0 to 300%	Set the converted % of the gain current (voltage) for the terminal 4 input.

*1 The parameter number in parentheses is the one for use with the LCD operation panel and the parameter unit.

◆ To change the frequency for the maximum analog input (Pr.125, Pr.126)

- Use **Pr.125 (Pr.126)** to change the frequency setting (gain) for the maximum analog input voltage (current). (C2 (Pr.902) to C7 (Pr.905) settings do not need to be changed.)

◆ Analog input bias/gain calibration (C2 (Pr.902) to C7 (Pr.905))

- The "bias" and "gain" functions serve to adjust the relationship between a setting input signal and the output frequency. A setting input signal is such as a 0 to 5 VDC, 0 to 10 VDC, or 4 to 20 mADC signal externally input to set the output frequency.
- Set the bias frequency of the terminal 2 input using **C2 (Pr.902)**. (It is initially set to the frequency at 0 V.)
- Use **Pr.125** to set the output frequency to the frequency command voltage (current) set by **Pr.73 Analog input selection**.
- Set the bias frequency of the terminal 4 input using **C5 (Pr.904)**. (It is initially set to the frequency at 4 mA.)
- Use **Pr.126** to set the output frequency to the 20 mA input of the frequency command current (4 to 20 mA).

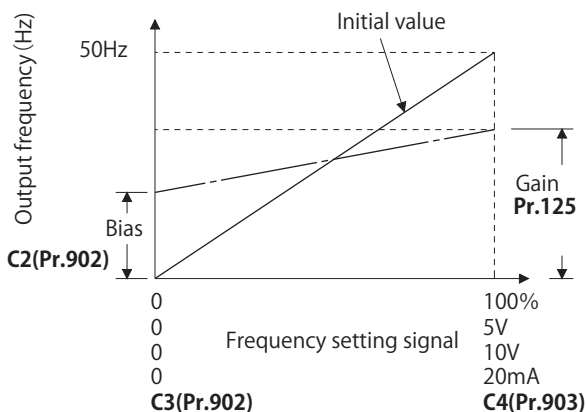

- There are three methods to adjust the bias/gain frequency setting voltage (current).
 Adjustment by applying voltage (current) between terminals 2 and 5 (4 and 5) to set the voltage (current) at the bias/gain torque. [page 136](#)
 Adjustment by selecting the voltage (current) at the bias/gain torque without applying voltage (current) between terminals 2 and 5 (4 and 5). [page 137](#)
 Adjustment by changing the frequency without adjusting the voltage (current). [page 138](#)















NOTE

- Always calibrate the input after changing the voltage/current input signal with Pr.73 (Pr.267) and the voltage/current input selection switch.

◆ Frequency setting voltage (current) bias/gain adjustment method

















■ Adjustment by applying voltage (current) between terminals 2 and 5 (4 and 5) to set the voltage (current) at the bias/gain frequency (Example of adjustment at the gain frequency)

Operating procedure



1. Turning ON the power of the inverter
The operation panel is in the monitor mode.
2. Selecting the parameter setting mode
Press  to choose the parameter setting mode.
3. Calibration parameter selection
Press  or  to show "f. . . ". Press  to display "f - - -".
4. Selecting the parameter number
Press  or  to show "f 4" (C4 (Pr.903) Terminal 2 frequency setting gain) for terminal 2, or "f 7" (C7 (Pr.905) Terminal 4 frequency setting gain) for terminal 4.
5. Analog voltage (current) display
Press  to display the analog voltage (current) value (%) currently applied to terminal 2 (4).
Do not press  or  before calibration is completed.
6. Voltage (current) application
Apply a 5 V (20 mA). (Turn the external potentiometer connected between terminals 2 and 5 (terminals 4 and 5) to a desired position.)
7. Setting completed
Press  to confirm the selection. The analog voltage (current) % and "f 4" ("f 7") are displayed alternately.
 - Press  or  to read another parameter.
 - Press  to return to the "f - - -" display.
 - Press  twice to show the next parameter.

■ Adjustment by selecting the voltage (current) at the bias/gain frequency without applying voltage (current) between terminals 2 and 5 (4 and 5) (Example of adjustment at the gain frequency)

Operating procedure

1. Turning ON the power of the inverter
The operation panel is in the monitor mode.
2. Changing the operation mode
Press  to choose the PU operation mode. The [PU] indicator turns ON.
3. Selecting the parameter setting mode
Press  to choose the parameter setting mode. (The parameter number read previously appears.)
4. Calibration parameter selection
Press  or  to show "f . . .". Press  to display "f - - -".
5. Selecting the parameter number
Press  or  to show "f 4" (C4 (Pr.903) Terminal 2 frequency setting gain) for terminal 2, or "f 7" (C7 (Pr.905) Terminal 4 frequency setting gain) for terminal 4.
6. Analog voltage (current) display
Press  to display the analog voltage (current) value (%) currently applied to terminal 2 (4).
7. Analog voltage (current) adjustment
When  or  is pressed, the gain voltage (current) value (%) currently set to the parameter appears.
Press  or  to show the desired gain voltage (current) value (%).
8. Setting completed
Press  to confirm the selection. The analog voltage (current) % and "f 4" ("f 7") are displayed alternately.
 - Press  or  to read another parameter.
 - Press  to return to the "f - - -" display.
 - Press  twice to show the next parameter.

NOTE

- Press  or  after step 6 to check the present bias/gain frequency setting. The setting cannot be checked after step 7.

■ Adjustment by changing the frequency without adjusting the voltage (current) (Example of changing the gain frequency from 60 Hz to 50 Hz)

Operating procedure

1. Selecting the parameter

Press \uparrow or \downarrow to show "P. 125" (Pr.125) for terminal 2, or "P. 126" (Pr.126) for terminal 4.

Press SET to read the present set value. (60.00 Hz)

2. Changing the maximum frequency

Press \uparrow or \downarrow to change the set value to "50.00". (50.00 Hz)

Press SET to confirm the selection. "50.00" and "P. 125" ("P. 126") are displayed alternately.

3. Selecting the mode and the monitor item

Hold down MODE to select the monitor mode, and change the monitor item to the frequency.

4. Start

Turn ON the start switch (STF/STR signal), and turn the frequency setting potentiometer clockwise slowly to full. The motor is operated at 50 Hz.

NOTE

- If the voltage (current) values at the gain and bias frequencies are too close to each other, an error "Er3" may be indicated.
- Changing C4 (Pr.903) or C7 (Pr.905) (gain adjustment) will not change Pr.20.
- For operation outline of the parameter unit (FR-PU07), refer to the Instruction Manual of the FR-PU07.
- To set the value to 120 Hz or higher, the Pr.18 High speed maximum frequency needs to be 120 Hz or higher. (Refer to page 117.)
- Use the calibration parameter C2 (Pr.902) or C5 (Pr.904) to set the bias frequency. (Refer to page 135.)

CAUTION

- Be cautious when setting any value other than "0" as the bias frequency at 0 V (0 mA). Even if a speed command is not given, simply turning ON the start signal will start the motor at the preset frequency.

Parameters referred to

Pr.1 Maximum frequency, Pr.18 High speed maximum frequency \rightarrow page 117

Pr.20 Acceleration/deceleration reference frequency \rightarrow page 93

Pr.73 Analog input selection, Pr.267 Terminal 4 input selection \rightarrow page 131

Pr.79 Operation mode selection \rightarrow page 100

5.8.4 Checking of current input on analog input terminal

When current is input to the analog input terminal 4, the input current can be checked and the operation when the input falls below the specified level (the analog current input is lost) can be selected. The operation can be continued even when the analog current input is lost.

Pr.	Name	Initial value	Setting range	Description
573 T052	4 mA input check selection	9999	1	Operation continues with output frequency before the current input loss.
			2	The protective function E.LCI (4 mA input fault) is activated when the current input loss is detected.
			3	The inverter output decelerates the motor to a stop when the current input loss is detected. The protective function E.LCI (4 mA input fault) is activated after the motor is stopped.
			9999	No current input check
778 T054	4 mA input check filter	0 s	0 to 10 s	Set the current input loss detection time.

5

◆ Analog current input loss condition (Pr.778)

- When the current input to terminal 4 continues to be 2 mA or less for the period set in Pr.778, it is considered as loss of analog current input and the Alarm (LF) signal is turned ON. The LF signal turns OFF when the current input becomes 3 mA or higher.
- For the LF signal, set "98 (positive logic) or 198 (negative logic)" in Pr.195 (Output terminal function selection) to assign the function.

Set frequency

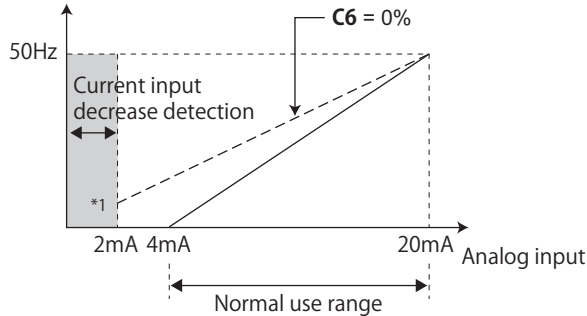

*1 When Pr.573 ≠ "9999" and the terminal 4 input is calibrated to 2 mA or less in C2 (Pr.902), the operation set in Pr.573 is applied to the frequency at the input of 2 mA or less.

NOTE

- Changing the terminal assignment using Pr.195 (Output terminal function selection) may affect the other functions. Set parameters after confirming the function of the terminal.

◆ Continuing operation when the analog current input is lost (Pr.573 = "1")

- When Pr.573 = "1", operation continues at the output frequency before the current input loss.
- When the start command is turned OFF during current input loss, the inverter output decelerates the motor to a stop immediately, and the operation is not restarted even if a start command is input again.
- When the current input is restored, the LF signal is turned OFF, and operation is performed according to the current input.

- The following is the operation example during External operation.

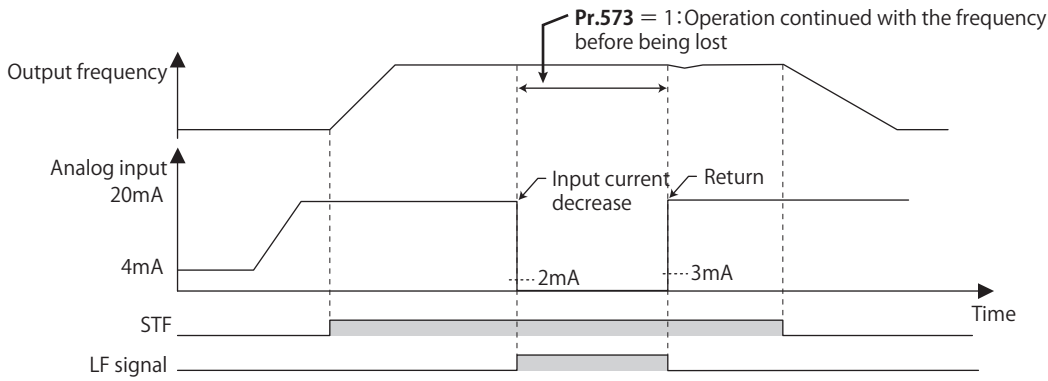

- The following is the operation example during PID control (reverse action) operation.

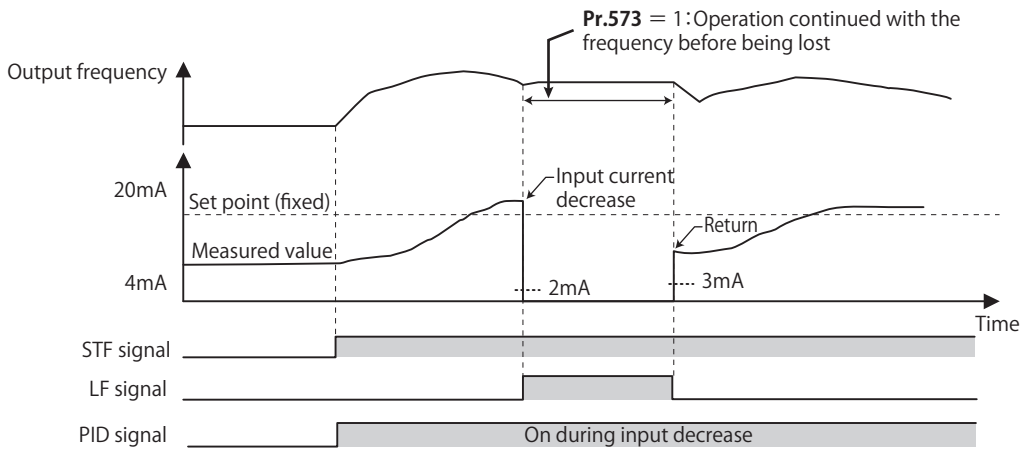

NOTE

- When the setting is changed to the continuous operation (**Pr.573 = "1"**) after the input current loss, the frequency before loss is regarded as 0 Hz.

◆ Fault output (Pr.573 = "2")

- When the analog current input becomes 2 mA or lower, the protective function E.LCI (4 mA input fault) is activated and the output is shut off.
- The following is the operation example during PID control (reverse action) operation.

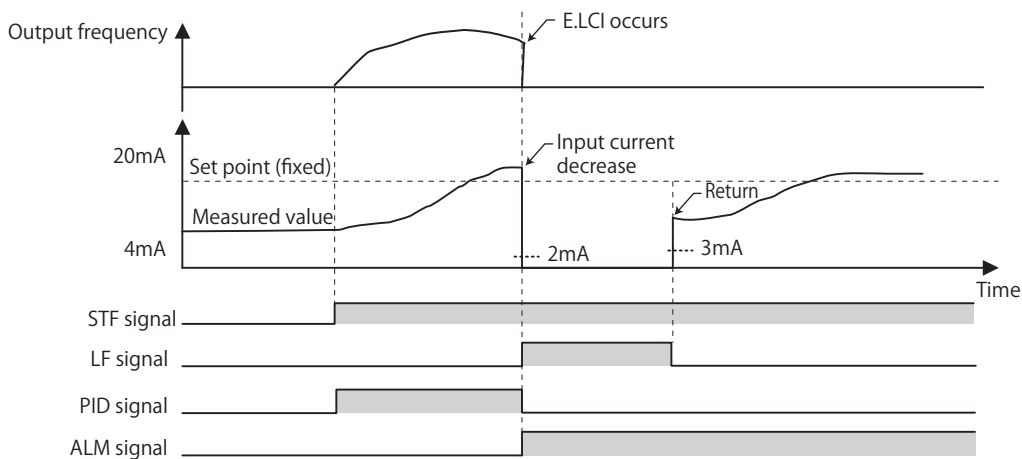

◆ Fault output after deceleration to stop (Pr.573 = "3")

- When the analog current input becomes 2 mA or lower, the inverter output decelerates the motor to a stop, and then the protective function E.LCI (4 mA input fault) is activated and the output is shut off.
- When the analog current input is restored during the deceleration, the motor is accelerated again and operates according to the current input.
- The following is the operation example during PID control (reverse action) operation.

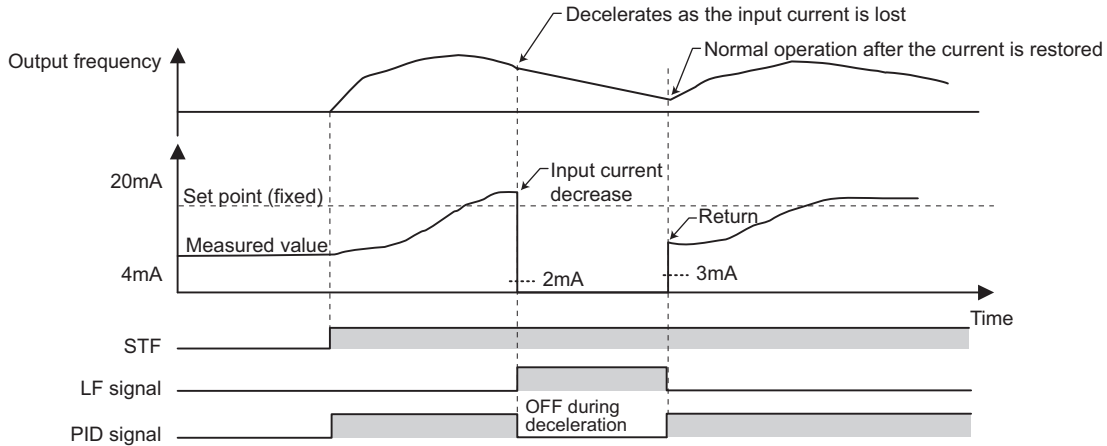

- The following is the operation example when the analog input current is restored during deceleration under PID control (reverse action).

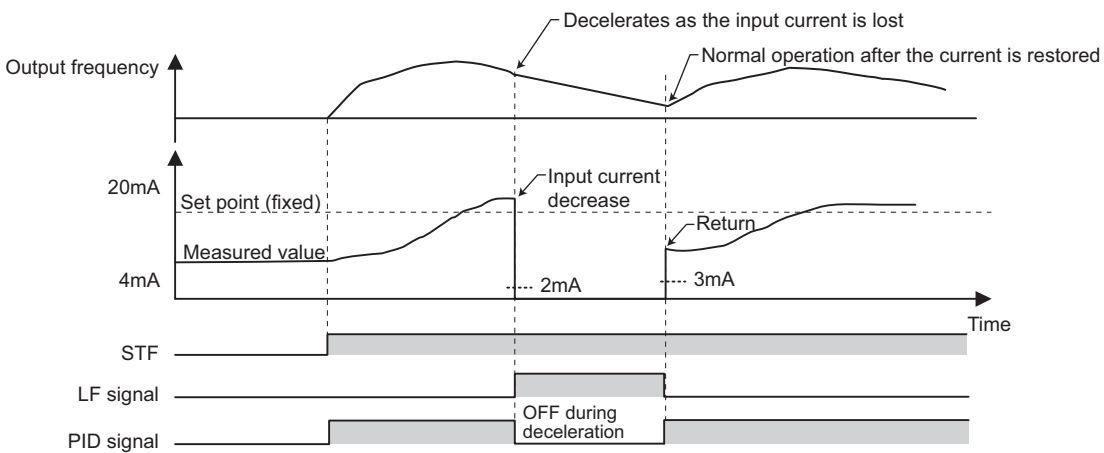

◆ Functions related to current input check

Function	Operation	Refer to page
Minimum frequency	When the operation continues, the minimum frequency setting is valid even during current input loss.	117
Multi-speed operation	The multi-speed setting signal is prioritized even during current input loss (the motor operates according to the multi-speed setting even during continuous operation at the predetermined frequency or during deceleration to a stop). When the multi-speed setting signal is turned OFF while the input current is lost during the multi-speed operation, the motor is decelerated to a stop even if the parameter is set to continue operation when the current input is lost.	109
JOG operation	JOG operation is prioritized even during current input loss (the motor operation switches to JOG operation even during continuous operation at the predetermined frequency or during deceleration to a stop). When the JOG signal is turned OFF while the input current is lost during the JOG operation, the motor is decelerated to a stop even if the parameter is set to continue operation when the current input is lost.	108
MRS signal	The MRS signal is enabled even during current input loss (output is shut off by turning ON the MRS signal even during continuous operation at the predetermined frequency or during deceleration to a stop).	143
Remote setting	When the operation using the remote setting function is changed to the continuous operation after the current input is lost, acceleration, deceleration, and clear operations by the remote setting are disabled. The operations are enabled after restoration of current input.	96
Retry function	When the protective function is activated during continuous operation after the current input is lost and the retry function is used successfully, operation continues without clearing the frequency setting.	115
Input filter time constant	The current before the filter time is applied is used for input loss detection. The current after the filter time is applied is used for continuous operation at the output frequency before the input loss.	139
PID control	PID calculation is stopped during current input loss. However, PID control is not disabled (the operation does not return to normal). The sleep function is prioritized even during current input loss. When the clearing condition of the sleep function is met during current input loss, continuous operation at the predetermined frequency is restored.	152
Power failure stop	The power failure stop function is prioritized even if current input loss is detected during power failure. After the power failure stop and re-acceleration, operation continues at the output frequency before the input loss. When the protective function E.LCI is selected when the current input is lost, E.LCI is activated after the power failure stop.	160
Traverse function	Traverse operation is performed based on the frequency even during continuous operation during current input loss.	151

◀ Parameters referred to ▶

Pr.73 Analog input selection, Pr.267 Terminal 4 input selection  page 131

5.8.5 Input terminal function selection

Use the following parameters to select or change the input terminal functions.

Pr.	Name	Initial value	Initial signal	Setting range
178 T700	STF terminal function selection	60	STF (Forward rotation command)	0 to 5, 7, 8, 10, 14, 24, 25, 37, 60, 62, 9999
179 T701	STR terminal function selection	61	STR (Reverse rotation command)	0 to 5, 7, 8, 10, 14, 24, 25, 37, 61, 62, 9999
180 T702	RL terminal function selection	0	RL (Low-speed operation command)	0 to 5, 7, 8, 10, 14, 24, 25, 37, 62, 9999
181 T703	RM terminal function selection	1	RM (Middle speed operation command)	
182 T704	RH terminal function selection	2	RH (High-speed operation command)	

◆ Input terminal function assignment

- Use Pr.178 to Pr.182 to set the functions of the input terminals.

- Refer to the following table and set the parameters.

Setting	Signal name	Function		Related parameter	Refer to page
0	RL	Pr.59 = 0 (initial value)	Low-speed operation command	Pr.4 to Pr.6, Pr.24 to Pr.27, Pr.232 to Pr.239	109
		Pr.59 ≠ 0*1	Remote setting (setting clear)	Pr.59	96
1	RM	Pr.59 = 0 (initial value)	Middle-speed operation command	Pr.4 to Pr.6, Pr.24 to Pr.27, Pr.232 to Pr.239	109
		Pr.59 ≠ 0*1	Remote setting (deceleration)	Pr.59	96
2	RH	Pr.59 = 0 (initial value)	High-speed operation command	Pr.4 to Pr.6, Pr.24 to Pr.27, Pr.232 to Pr.239	109
		Pr.59 ≠ 0*1	Remote setting (acceleration)	Pr.59	96
3	RT	Second function selection		Pr.44, Pr.45, etc.	93
4	AU	Terminal 4 input selection		Pr.267	131
5	JOG	JOG operation selection		Pr.15, Pr.16	108
7	OH	External thermal relay input*2		Pr.9	112
8	REX	15-speed selection (combination with three speeds RL, RM, and RH)		Pr.4 to Pr.6, Pr.24 to Pr.27, Pr.232 to Pr.239	109
10	X10	Inverter run enable (FR-HC2/FR-CV connection)		Pr.30	118
14	X14	PID control valid		Pr.127 to Pr.134, Pr.575 to Pr.577	152
24	MRS	Output stop		Pr.17	143
25	STP (STOP)	Start self-holding selection		Pr.250	145
37	X37	Traverse function selection		Pr.592 to Pr.597	151
60	STF	Forward rotation command (assigned to STF terminal (Pr.178) only)		Pr.250	145
61	STR	Reverse rotation command (assigned to STR terminal (Pr.179) only)		Pr.250	145
62	RES	Inverter reset		Pr.75	85
9999	—	No function		—	—

*1 When Pr.59 Remote function selection ≠ "0", functions of the RL, RM, and RH signals are changed as shown in the table.

*2 The OH signal is activated when the relay contact is open.

NOTE

- The same function can be assigned to two or more terminals. In this case, the logic of terminal input is OR.
- The priorities of the speed commands are defined as follows: JOG > multi-speed setting (RH, RM, RL, REX) > PID (X14).
- When the Inverter run enable (X10) signal is not assigned, the RT signal performs the same function.
- The same terminals are used to assign the multi-speed (7-speed) setting and the remote setting. The multi-speed setting and the remote setting cannot be assigned separately.
- When the terminal assignment is changed with Pr.178 to Pr.182 (Input terminal function selection), wiring may be mistaken due to different terminal name and signal contents, or may affect other functions. Set parameters after confirming the function of each terminal.

5.8.6 Inverter output shutoff

The inverter output can be shut off with the MRS signal. The logic of the MRS signal can also be selected.

Pr.	Name	Initial value	Setting range	Description
17 T720	MRS input selection	0	0	Normally open input
			2	Normally closed input (NC contact input specification)
			4	External terminal: Normally closed input (NC contact input specification) Communication: Normally open input

◆ Output shutoff signal (MRS signal)

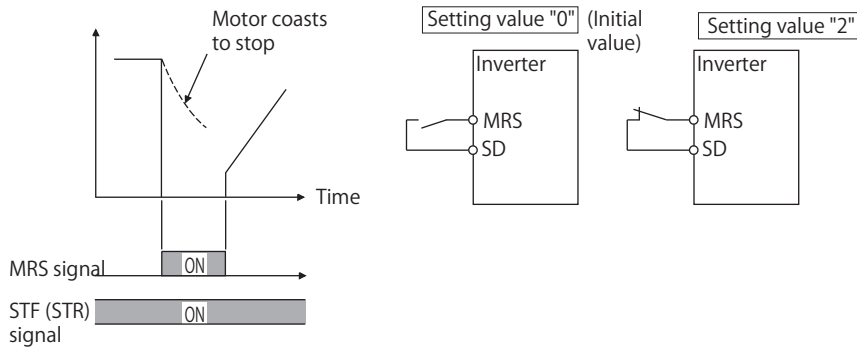

- When the Output stop (MRS) signal is turned ON while operating the inverter, the inverter output is instantaneously shut off.
- The response time of the MRS signal is within 2 ms.
- The MRS signal is used in the following cases.

Application	Description
To stop the motor using a mechanical brake (e.g. electromagnetic brake)	The inverter output is shut off when the mechanical brake operates.
To provide interlock to disable the motor operation by the inverter	With the MRS signal ON, the motor cannot be driven by the inverter even if the start signal is input to the inverter.
To coast the motor to a stop	When the start signal is turned OFF, the inverter decelerates the motor to a stop in the preset deceleration time, but when the MRS signal is turned ON, the motor coasts to a stop.

◆ MRS signal logic inversion (Pr.17 = "2")

- When "2" is set in Pr.17, the input specification of the MRS signal is changed to normally closed (NC contact). The inverter will shut off the output when the MRS signal is turned ON (when the contact is opened).

◆ Assigning a different action for each MRS signal input via communication and external terminal (Pr.17 = "4")

- When Pr.17 = "4", the MRS signal input from an external terminal is normally closed (NC contact), and the MRS signal input from communication is normally open (NO contact). This function is useful to perform operation via communication while keeping the ON state of the MRS signal input from the external terminal.

External MRS	Communication MRS	Pr.17 setting		
		0	2	4
OFF	OFF	Operation enabled	Output shutoff	Output shutoff
OFF	ON	Output shutoff	Output shutoff	Output shutoff
ON	OFF	Output shutoff	Output shutoff	Operation enabled
ON	ON	Output shutoff	Operation enabled	Output shutoff

NOTE

- The MRS signal is assigned to terminal MRS in the initial status. Set "24" in any of **Pr.178 to Pr.182 (Input terminal function selection)** to assign the MRS signal to another terminal.
- When using an external terminal to input the MRS signal, the MRS signal shuts off the output in any of the operation modes.
- The MRS signal is valid regardless of whether it is input through the external terminal or via network, but when the MRS signal is used as the Inverter run enable (X10) signal, input the signal through the external terminal.
- When the terminal assignment is changed with **Pr.178 to Pr.182 (Input terminal function selection)**, wiring may be mistaken due to different terminal name and signal contents, or may affect other functions. Set parameters after confirming the function of each terminal.

Parameters referred to

Pr.178 to Pr.182 (Input terminal function selection) [page 142](#)

5.8.7 Start signal operation selection

Operation of the start signal (STF/STR) can be selected.

Select the stopping method (deceleration stop or casting) at turn-OFF of the start signal.

Use this function to stop a motor with a mechanical brake at turn-OFF of the start signal.

Pr.	Name	Initial value	Setting range	Description	
				Start signal (STF/STR)	Stop operation (refer to page 198)
250 G106	Stop selection	9999	0 to 100	STF signal: Forward rotation start STR signal: Reverse rotation start	The inverter output is shut off 0 to 100 seconds after the start signal is turned OFF.
			1000 to 1100	STF signal: Start signal STR signal: Forward/reverse rotation signal	Add 1000 to the desired number of seconds as the setting value of Pr.250 as required by the STF and STR signal settings.
			9999	STF signal: Forward rotation start STR signal: Reverse rotation start	The motor is decelerated to a stop when the start signal is turned OFF.

5

◆ 2-wire type (STF signal, STR signal)

- The following figure shows the 2-wire type connection.
- As an initial setting, the forward/reverse rotation signals (STF/STR) acts as both start and stop signals. Either one turned ON will be enabled, and the operation will follow that signal. The motor will decelerate to a stop when both are turned OFF (or both are turned ON) during the operation.
- The frequency can be set by inputting 0 to 10 VDC between the speed setting input terminals 2 and 5, or with Pr.4 to Pr.6 **Multi-speed setting (high speed, middle speed, and low speed)**. (For multi-speed operation, refer to page 109.)
- By setting Pr.250 = "1000 to 1100", the STF signal input becomes the start command and the STR signal input becomes the forward/reverse command.

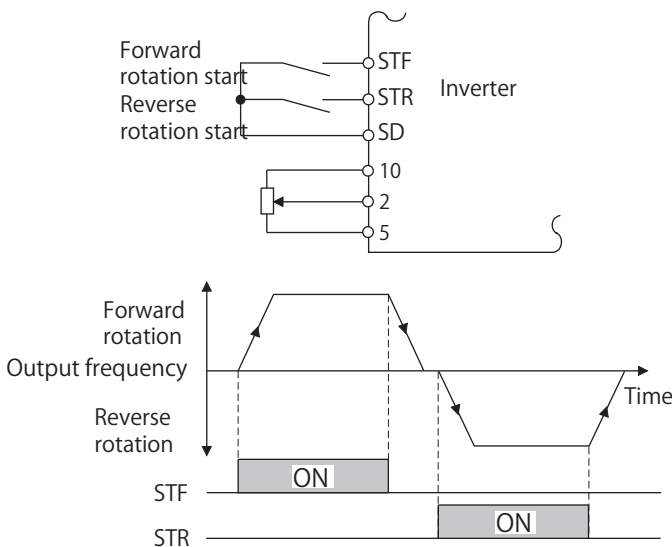

2-wire type connection example (Pr.250 = "9999")

NOTE

- By setting Pr.250 = "0 to 100, 1000 to 1100", the motor will coast to a stop when the start command is turned OFF. (Refer to page 198.)
- The STF and STR signals are assigned to the STF and STR terminals in the initial status. The STF signal can be assigned to terminal STF only using Pr.178 **STF terminal function selection**, and the STR signal can be assigned to terminal STR only using Pr.179 **STR terminal function selection**.

◆ 3-wire type (STF signal, STR signal, STP (STOP) signal)

- The following figure shows the 3-wire type connection.
- The self-holding function is enabled when the STP (STOP) signal is turned ON. In such case, the forward/reverse signal is simply used as a start signal.
- Even if a start signal (STF or STR) is turned ON and then OFF, the start command remains valid and the motor operation continues. To change the rotation direction, turn the STR (STF) signal ON once and then OFF.
- In order to decelerates the motor to a stop, turn OFF the STP (STOP) signal once.

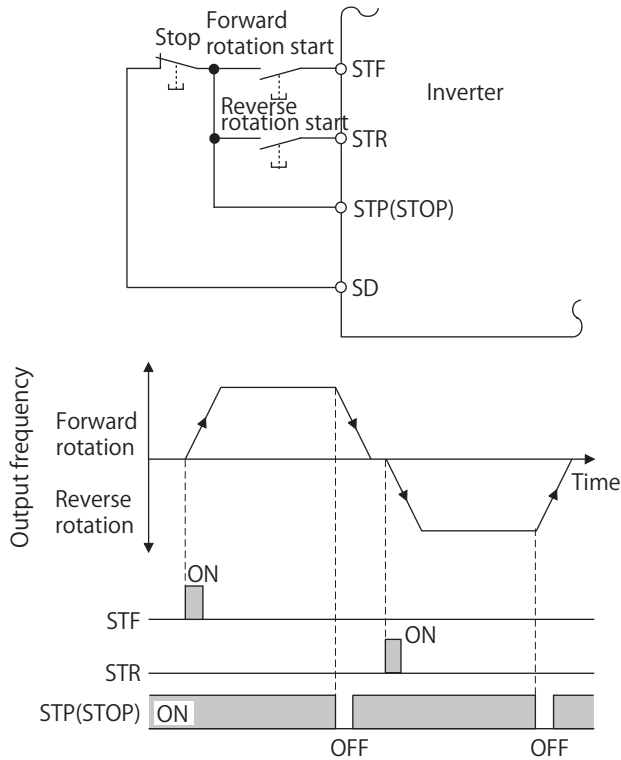

3-wire type connection example (Pr.250 = "9999")

NOTE

- Set "25" in any of **Pr.178 to Pr.182** to assign the STP (STOP) signal to another terminal.
- When the JOG operation is enabled by turning ON the JOG signal, the STOP signal will be disabled.
- Even when the output is stopped by turning ON the MRS signal, the self-holding function is not canceled.

◆ Start signal selection

STF	STR	Pr.250 setting and inverter condition	
		0 to 100 s, 9999	1000 to 1100 s, 8888
OFF	OFF	Stop	Stop
OFF	ON	Reverse rotation	
ON	OFF	Forward rotation	Forward rotation
ON	ON	Stop	Reverse rotation

Parameters referred to

Pr.4 to Pr.6 (Multi-speed setting) [page 109](#)

Pr.178 to Pr.182 (Input terminal function selection) [page 142](#)

5.9 (C) Motor constant parameters

Purpose	Parameter to set			Refer to page
To select the motor to be used	Applied motor	P.C100	Pr.71	147
To maximize the performance of the induction motor	Offline auto tuning	P.C100, P.C101, P.C103, P.C110, P.C120, P.C125	Pr.9, Pr.71, Pr.80, Pr.82, Pr.90, Pr.96	147

5.9.1 Applied motor

By setting the applied motor type, the thermal characteristic appropriate for the motor can be selected.

Pr.	Name	Initial value	Setting range	Description
71 C100	Applied motor	0	0 to 2	By selecting a motor, the thermal characteristic and motor constant of each motor are set.

◆ Setting the applied motor

- Refer to the following list and set the parameters according to the applied motor.

Pr.71	Motor	Electronic thermal O/L relay function	
		Standard	Constant-torque
0 (Pr.71 initial value)	Standard motor	○	
1	Constant-torque motor		○
2	Standard motor Adjustable 3 points V/F (Refer to page 195 .)	○	

NOTE

- Regardless of the Pr.71 setting, offline auto tuning can be performed according to **Pr.96 Auto tuning setting/status**. (Refer to [page 147](#) for offline auto tuning.)

Parameters referred to

Pr.0 Torque boost [page 193](#)
 Pr.12 DC injection brake operation voltage [page 197](#)
 Pr.96 Auto tuning setting/status [page 147](#)
 Pr.100 to Pr.105 (Adjustable 3 points V/F) [page 195](#)
 Pr.178 to Pr.182 (Input terminal function selection) [page 142](#)

5.9.2 Offline auto tuning

GP.MFVC

The offline auto tuning enables the optimal operation of a motor.

- Under General-purpose magnetic flux vector control, offline auto tuning enables optimal operation of motors even when the wiring distance is long.

Pr.	Name	Initial value	Setting range	Description
71 C100	Applied motor	0	0 to 2	By selecting a motor, the thermal characteristic and motor constant of each motor are set.
80 C101	Motor capacity	9999	0.2 to 15 kW 9999	Set the applied motor capacity. V/F control
9 C103	Electronic thermal O/L relay	Inverter rated current	0 to 500 A	Set the rated motor current.
96 C110	Auto tuning setting/status	0	0 1	No offline auto tuning Offline auto tuning is performed without rotating the motor.
90 C120	Motor constant (R1)	9999	0 to 50 Ω, 9999	Tuning data (The value measured by offline auto tuning is automatically set.)
82 C125	Motor excitation current	9999	0 to 500 A, 9999	9999: The constant value of Mitsubishi Electric motor is used.

Point

- When the wiring length between the inverter and the motor is long (30 m or longer as a reference), use the offline auto tuning function to drive the motor in the optimum operation characteristic.
- Tuning is enabled even when a load is connected to the motor.
- Reading/writing of the motor constants tuned by offline auto tuning are enabled. The offline auto tuning data (motor constants) can be copied to another inverter using the operation panel.
- The offline auto tuning status can be monitored with the operation panel or the parameter unit.

◆ Before performing offline auto tuning

Check the following points before performing offline auto tuning:

- A value other than "9999" is set in Pr.80, and General-purpose magnetic flux vector control is selected.
- A motor is connected. (Check that the motor is not rotated by an external force during tuning.)
- Select a motor with the rated current equal to or less than the inverter rated current. (The motor capacity must be 0.4 kW or higher.) If a motor with substantially low rated current compared with the inverter rated current, however, is used, speed and torque accuracies may deteriorate due to torque ripples, etc. Set the rated motor current to about 40% or higher of the inverter rated current.
- Tuning is not available for a high-slip motor, high-speed motor, or special motor.
- The maximum frequency is 400 Hz.
- The motor may rotate slightly even if the offline auto tuning without motor rotation (**Pr.96 Auto tuning setting/status = "1"**) is selected. (The slight motor rotation does not affect the tuning performance.)
Fix the motor securely with a mechanical brake, or before tuning, make sure that it is safe even if the motor rotates. (Caution is required especially in vertical lift applications.)
- Offline auto tuning is not performed correctly when the surge voltage suppression filter (FR-ASF-H/FR-BMF-H) is inserted between the inverter and motor. Be sure to remove it before performing tuning.

◆ Setting

- To perform tuning, set the following parameters about the motor.

First motor Pr.	Name	Initial value	Description
80	Motor capacity	9999 (V/F control)	Set the motor capacity (kW).
9	Electronic thermal O/L relay	Inverter rated current	Set the rated motor current (A).
71	Applied motor	0 (standard motor)	Set this parameter according to the motor.
96	Auto tuning setting/status	0	Set "1". 1: Tuning is performed without rotating the motor. (Excitation noise occurs at this point.)

◆ Performing tuning

Point

- Before performing tuning, check the monitor display of the operation panel or parameter unit if the inverter is in the state ready for tuning. The motor starts by turning ON the start command while tuning is unavailable







- In the PU operation mode, press  on the operation panel.
For External operation, turn ON the start command (STF signal or STR signal). Tuning starts.

NOTE

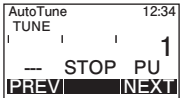
- Satisfy the required inverter start conditions to start offline auto tuning. For example, stop the input of the MRS signal.
- To force tuning to end, use the MRS or RES signal or press  on the operation panel.
(Turning the start signal (STF signal or STR signal) OFF also ends tuning.)
- During offline auto tuning, only the following I/O signals are valid. (initial value).
Input terminal: STF, STR
Output terminal: ABC

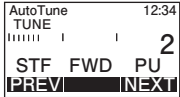
- During execution of offline auto tuning, do not switch ON/OFF the Second function selection (RT) signal. Auto tuning will not be performed properly.
- Setting offline auto tuning (**Pr.96 Auto tuning setting/status = "1"**) will make pre-excitation invalid.
- Since the Inverter running (RUN) signal turns ON when tuning is started, caution is required especially when a sequence which releases a mechanical brake by the RUN signal has been designed.
- When executing offline auto tuning, input the run command after switching ON the main circuit power (R/L1, S/L2, T/L3) of the inverter.

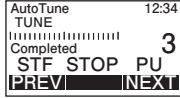
- During tuning, the monitor is displayed on the operation panel as follows.

	Parameter unit (FR-LU08) display	Operation panel indication
(1) Setting		
(2) During tuning		
(3) Normal completion		

- When offline auto tuning ends, press  on the operation panel during PU operation. For External operation, turn OFF the start signal (STF signal or STR signal).
This operation resets the offline auto tuning, and the PU's monitor display returns to the normal indication.
(Without this operation, next operation cannot be started.)

NOTE

- The motor constants measured once during offline auto tuning are stored as parameters and their data are held until offline auto tuning is performed again. However, the tuning data is cleared when performing All parameter clear.
- Changing **Pr.71** after tuning completion will change the motor constant.

- If offline auto tuning has ended in error (see the following table), motor constants are not set. Perform an inverter reset and perform tuning again.

Error display	Error cause	Countermeasures
8	Forced end	Set "1" in Pr.96 and retry the tuning.
9	Inverter protective function operation	Make the setting again.
91	The current limit (stall prevention) function is activated.	Set the acceleration/deceleration time longer. Set Pr.156 Stall prevention operation selection = "1" .
92	The converter output voltage fell to 75% of the rated voltage.	Check for the power supply voltage fluctuation. Check the Pr.3 setting.
93	Calculation error. The motor is not connected.	Check the Pr.3 and Pr.19 settings. Check the motor wiring and make the setting again.

- When tuning is ended forcibly by pressing  or turning OFF the start signal (STF or STR) during tuning, offline auto tuning does not end properly. (The motor constants have not been set.)
Perform an inverter reset and perform tuning again.
- When the rated power supply of the motor is 200/220 V (400/440 V) 60 Hz, set the rated motor current multiplied by 1.1 in **Pr.9 Electronic thermal O/L relay** after tuning is complete.
- For a motor with a PTC thermistor, thermal protector, or other thermal detector, set "0" (motor overheat protection by inverter invalid) in **Pr.9** to protect the motor from overheating.

NOTE

- An instantaneous power failure occurring during tuning will result in a tuning error. After power is restored, the inverter starts normal operation. Therefore, when the STF (STR) signal is ON, the motor starts forward (reverse) rotation.
 - Any fault occurring during tuning is handled as in the normal operation. However, if the retry function is set, no retry is performed.
 - The set frequency monitor displayed during the offline auto tuning is 0 Hz.
-

◆ Changing the motor constant

- The motor constants can be set directly when the motor constants are known in advance, or by using the data measured during offline auto tuning.

NOTE

- If "9999" is set, tuning data will be invalid.
-

◀ Parameters referred to ▶

Pr.9 Electronic thermal O/L relay  [page 112](#)

Pr.71 Applied motor  [page 147](#)

Pr.156 Stall prevention operation selection  [page 119](#)

Pr.178 to Pr.182 (Input terminal function selection)  [page 142](#)

Pr.195 (Output terminal function selection)  [page 126](#)

5.10 (A) Application parameters

Purpose	Parameter to set			Refer to page
To strengthen or weaken the frequency at a constant cycle	Traverse operation	P.A300 to P.A305	Pr.592 to Pr.597	151
To perform process control, such as for the pump flow volume and air volume	PID control	P.A601, P.A602, P.A610 to P.A615, P.A621	Pr.127 to Pr.134, Pr.575	152
To continue operating at analog current input loss	4 mA input check	P.A680, P.A682	Pr.573, Pr.778	139
To restart without stopping the motor at instantaneous power failure	Automatic restart after instantaneous power failure / flying start function for induction motors	P.A702, P.A703, P.A710, P.F003	Pr.57, Pr.58, Pr.165, Pr.611	159
To decelerate the motor to a stop at instantaneous power failure	Power failure time deceleration-to-stop function	P.A730	Pr.261	160

5.10.1 Traverse function

The traverse operation, which oscillates the frequency at a constant cycle, is available.

Pr.	Name	Initial value	Setting range	Description
592 A300	Traverse function selection	0	0	Traverse function invalid
			1	Traverse function valid only in External operation mode
			2	Traverse function valid regardless of the operation mode
593 A301	Maximum amplitude amount	10%	0 to 25%	Level of amplitude during traverse operation
594 A302	Amplitude compensation amount during deceleration	10%	0 to 50%	Compensation amount during amplitude inversion (from acceleration to deceleration)
595 A303	Amplitude compensation amount during acceleration	10%	0 to 50%	Compensation amount during amplitude inversion (from deceleration to acceleration)
596 A304	Amplitude acceleration time	5 s	0.1 to 3600 s	Time period of acceleration during traverse operation
597 A305	Amplitude deceleration time	5 s	0.1 to 3600 s	Time period of deceleration during traverse operation

- Setting Pr.592 = "1 or 2" will enable the Pr.592 traverse function selection.
- Assigning the Traverse function selection (X37) signal to the input terminal enables the traverse function only when the X37 signal is ON. (When the X37 signal is not assigned, the traverse function is always available.) To input the X37 signal, set "37" in any of Pr.178 to Pr.182 (Input terminal function selection) to assign the function.

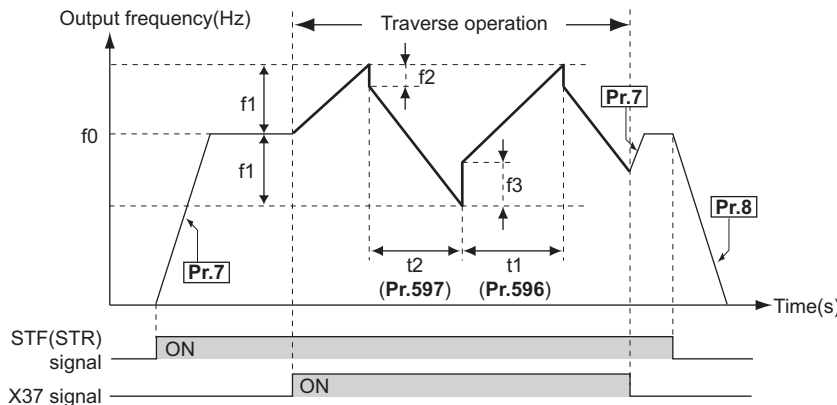

- f0: set frequency
- f1: amplitude amount from the set frequency ($f0 \times \text{Pr.593}/100$)
- f2: compensation amount at transition from acceleration to deceleration ($f1 \times \text{Pr.594}/100$)
- f3: compensation amount at transition from deceleration to acceleration ($f1 \times \text{Pr.595}/100$)
- t1: time from acceleration during traverse operation (Time from $(f0 - f1)$ to $(f0 + f1)$) (Pr.596)
- t2: time from deceleration during traverse operation (Time from $(f0 + f1)$ to $(f0 - f1)$) (Pr.597)

- The motor accelerates to the set frequency f_0 according to the normal **Pr.7 Acceleration time** at turn ON of the start command (STF or STR).
- When the output frequency reaches f_0 and the X37 signal turns ON, the inverter begins traverse operation and accelerates to $f_0 + f_1$. The acceleration time at this time is according to the **Pr.596** setting. (If the X37 signal turns ON before the output frequency reaches f_0 , traverse operation begins after the output frequency reaches f_0 .)
- After the inverter accelerates the motor to $f_0 + f_1$, this is compensated with f_2 , and the motor decelerates to $f_0 - f_1$. The deceleration time at this time is according to the **Pr.597** setting.
- After the inverter decelerates the motor to $f_0 - f_1$, this is compensated with f_3 , and the motor accelerates again to $f_0 + f_1$.
- When the X37 signal turns OFF during traverse operation, the inverter accelerates/decelerates the motor to f_0 according to the normal acceleration/deceleration time set in Pr.7/Pr.8. If the start command (STF or STR) is turned OFF during traverse operation, the inverter decelerates the motor to a stop according to the normal deceleration time set in Pr.8.

NOTE

- If the set frequency (f_0) and traverse operation parameters (**Pr.592 to Pr.597**) are changed during traverse operation, this is applied in operations after the output frequency reaches f_0 before the change was made.
- If the output frequency exceeds **Pr.1 Maximum frequency** or **Pr.2 Minimum frequency** during traverse operation, the output frequency is clamped at the maximum/minimum frequency when the set pattern exceeds the maximum/minimum frequency.
- When the traverse function and S-pattern acceleration/deceleration (**Pr.29** ≠ "0") are selected, S-pattern acceleration/deceleration operation occurs only in the range operated at the normal acceleration/deceleration time (**Pr.7, Pr.8**). Acceleration/deceleration during traverse operation is performed linearly.
- If stall prevention activates during traverse operation, traverse operation stops and normal operation begins. When stall prevention operation is completed, the inverter accelerates/decelerates to f_0 at the normal acceleration/deceleration time (**Pr.7, Pr.8**). After the output frequency reaches f_0 , the traverse operation begins again.
- If the value of the amplitude inversion compensation amount (**Pr.594, Pr.595**) is too large, an overvoltage trip or stall prevention occurs, and pattern operation cannot be performed as set.
- Changing the terminal assignment using **Pr.178 to Pr.182 (Input terminal function selection)** may affect the other functions. Set parameters after confirming the function of each terminal.

Parameters referred to

Pr.3 Base frequency [page 194](#)

Pr.178 to Pr.182 (Input terminal function selection) [page 142](#)

Pr.195 (Output terminal function selection) [page 126](#)

5.10.2 PID control

Process control such as flow rate, air volume or pressure are possible on the inverter.

A feedback system can be configured and PID control can be performed using the terminal 2 input signal or parameter setting value as the set point and the terminal 4 input signal as the feedback value.

Pr.	Name	Initial value	Setting range	Description
127 A612	PID control automatic switchover frequency	9999	0 to 400 Hz	Set the value at which control is automatically switched to PID control.
			9999	The PID control automatic switchover function is disabled.
128 A610	PID action selection	0	0, 20, 21	Select how to input the deviation value, measured value and set point, and forward and reverse action.
129 A613	PID proportional band	100%	0.1 to 1000%	If a narrow proportional band is set (small parameter setting value), the manipulated amount changes considerably by slight changes in the measured value. As a result, response improves as the proportional band becomes narrower, though stability worsens as shown by the occurrence of hunting. Gain $K_p=1/\text{proportional band}$
			9999	The proportional control is disabled.
130 A614	PID integral time	1 s	0.1 to 3600 s	With deviation step input, this is the time (T_i) used for obtaining the same manipulated amount as proportional band (P) by only integral (I) action. Arrival to the set point becomes quicker the shorter an integral time is set, though hunting is more likely to occur.
			9999	The integral control is disabled.
131 A601	PID upper limit	9999	0 to 100%	Set the upper limit. The FUP signal is output when the feedback value exceeds this setting. The maximum input (20 mA/5 V/10 V) of the measured value is equivalent to 100%.
			9999	No function

Pr.	Name	Initial value	Setting range	Description
132 A602	PID lower limit	9999	0 to 100%	Set the lower limit. The FDN signal is output when the measured value falls below the setting range. The maximum input (20 mA/5 V/ 10 V) of the measured value is equivalent to 100%.
			9999	No function
133 A611	PID action set point	9999	0 to 100%	Set the set point during PID control.
			9999	Set point set by Pr.128 .
134 A615	PID differential time	9999	0.01 to 10 s	With deviation ramp input, this is the time (Td) used for obtaining the manipulated amount only by proportional action (P). Response to changes in deviation increase greatly as the differential time increases.
			9999	The differential control is disabled.

◆ Basic configuration of PID control

■ Pr.128 = "20 or 21" (measured value input)

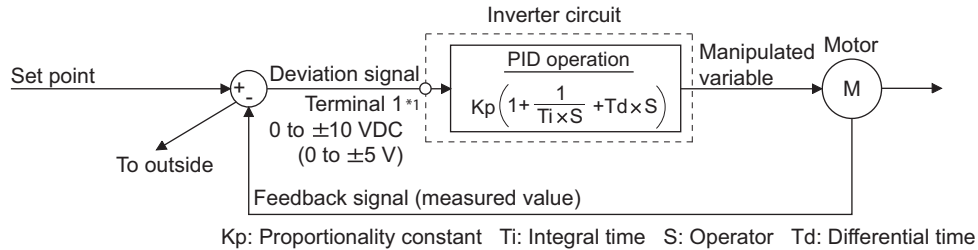

◆ PID action outline

■ PI action

PI action is a combination of proportional action (P) and integral action (I), and applies a manipulated amount according to the size of the deviation and transition or changes over time.

[Example of action when the measured value changes in a stepped manner]

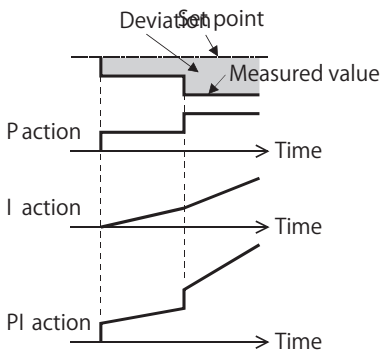

(Note) PI action is the result of P and I actions being added together.

■ PD action

PD action is a combination of proportional action (P) and differential action (D), and applies a manipulated amount according to the speed of the deviation to improve excessive characteristics.

[Example of action when the measured value changes proportionately]

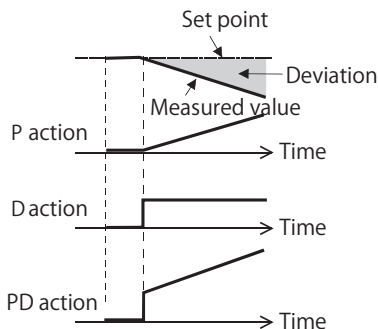

(Note) PD action is the result of P and D actions being added together.

■ PID action

PID action is a combination of PI and PD action, which enables control that incorporates the respective strengths of these actions.

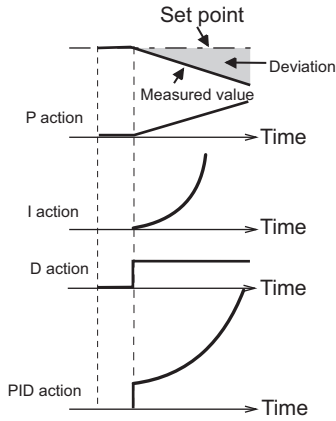

(Note) PID action is the result of all P, I and D actions being added together.

■ Reverse action

When deviation $X = (\text{set point} - \text{measured value})$ is a plus value, the manipulated amount (output frequency) is increased, and when the deviation is a minus value, the manipulated amount is decreased.

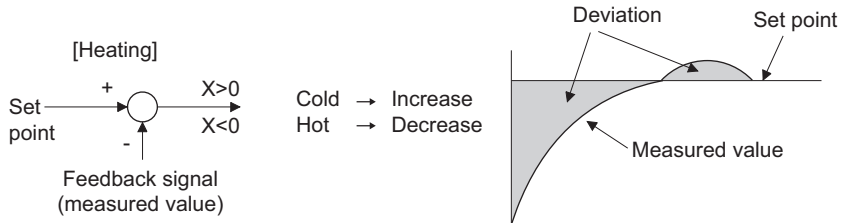

■ Forward action

When deviation $X = (\text{set point} - \text{measured value})$ is a minus value, the manipulated amount (output frequency) is increased, and when the deviation is a plus value, the manipulated amount is decreased.

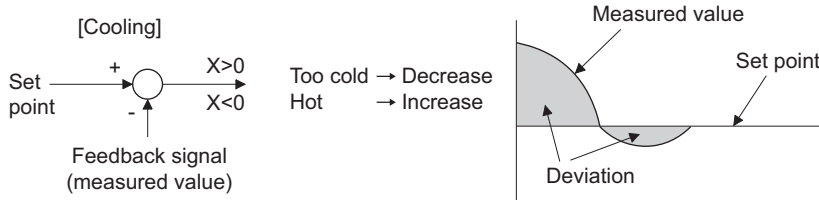

Relationship between deviation and manipulated amount (output frequency)

PID action setting	Deviation	
	Plus	Minus
Reverse action	↗	↘
Forward action	↘	↗

◆ Connection diagram

- Sink logic
- Pr.128 = "20"
- Pr.195 = "99"

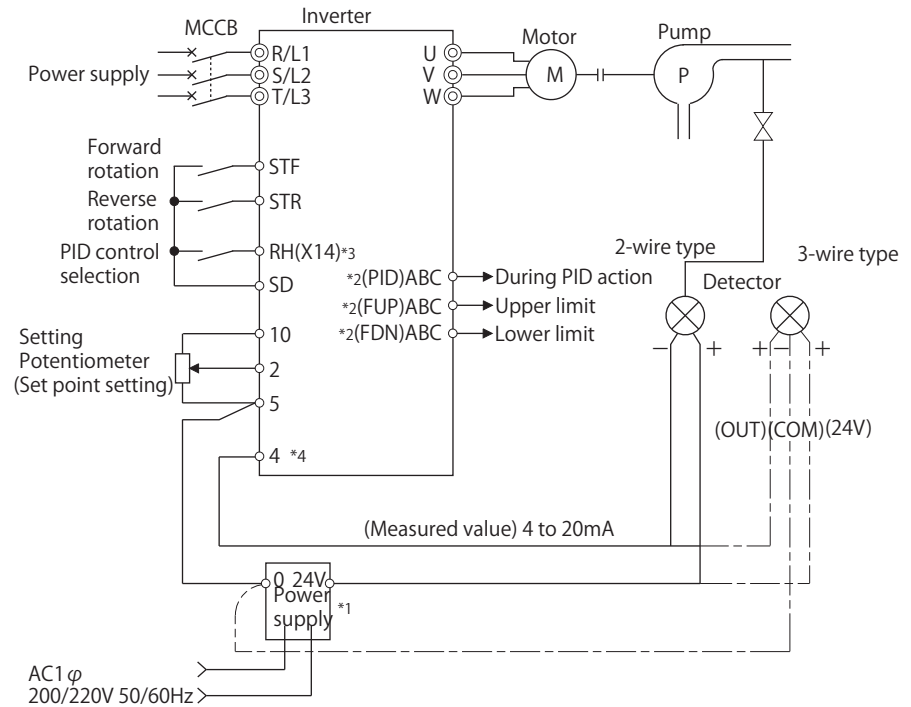

- *1 Prepare a power supply matched to the power supply specifications of the detector.
- *2 The output signal terminal to be used differs according to the Pr.195 (Output terminal function selection) setting.
- *3 The input signal terminal to be used differs according to the Pr.178 to Pr.182 (Input terminal function selection) setting.
- *4 There is no need to input AU signal.

◆ Input/output signals

- Assigning the PID control valid (X14) signal to the input terminal by Pr.178 to Pr.182 (Input terminal function selection) enables PID control to be performed only when the X14 signal is turned ON. When the X14 signal is OFF, regular inverter running is performed without PID action.
- Input signal

Signal	Function	Pr.178 to Pr.182 setting	Description
X14	PID control valid	14	When this signal is assigned to the input terminal, PID control is enabled when this signal is ON.

- Output signal

Signal	Function	Pr.195 setting		Description
		Positive logic	Negative logic	
FUP	PID upper limit	15	115	Output when the measured value signal exceeds Pr.131 PID upper limit.
FDN	Lower limit output	14	114	Output when the measured value signal falls below Pr.132 PID lower limit.
RL	PID forward/reverse rotation output	16	116	"Hi" is output when the output display of the parameter unit is forward rotation (FWD) and "Low" is output when the display is reverse rotation (REV) and stop (STOP).
PID	During PID control activated	47	147	Turns ON during PID control.
SLEEP	PID output interruption	70	170	Set Pr.575 Output interruption detection time ≠ "9999". This signal turns ON when the PID output suspension function is activated.

NOTE

- Changing the terminal functions with Pr.178 to Pr.182 or Pr.195 may affect other functions. Set parameters after confirming the function of each terminal.

◆ PID automatic switchover control (Pr.127)

- The system can be started up more quickly by starting up without PID control activated.
- When **Pr.127 PID control automatic switchover frequency** is set, the startup is made without PID control until the output frequency reaches the **Pr.127** setting. Once the PID control starts, the PID control is continued even if the output frequency drops to **Pr.127** setting or lower.

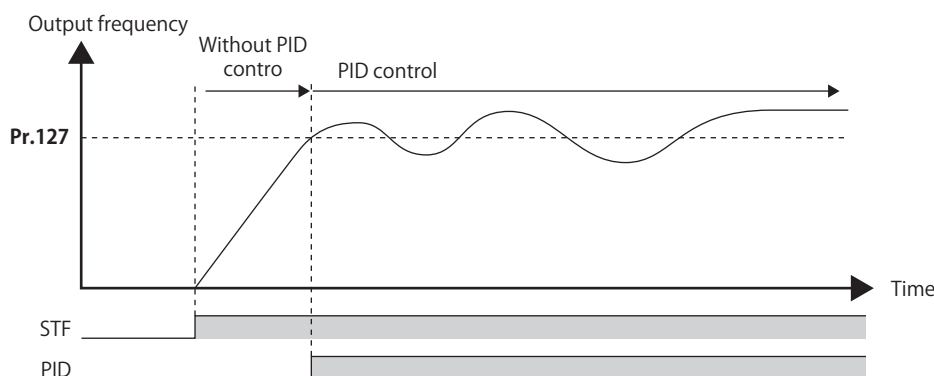

◆ PID output suspension function (sleep function) (SLEEP signal, Pr.575 to Pr.577)

- When a status where the output frequency after PID calculation is less than **Pr.576 Output interruption detection level** has continued for the time set in **Pr.575 Output interruption detection time** or longer, inverter running is suspended. This allows the amount of energy consumed in the inefficient low-speed range to be reduced.
- When the deviation (= set point - measured value) reaches the PID output shutoff release level (**Pr.577** setting value - 1000%) while the PID output suspension function is activated, the PID output suspension function is released, and PID control operation is automatically restarted.
- Whether to allow motor to coast to a stop or perform a deceleration stop when the sleep operation is started can be selected using **Pr.554**.
- While the PID output suspension function is activated, the PID output interruption (SLEEP) signal is output. During this time, the Inverter running (RUN) signal turns OFF and the During PID control activated (PID) signal turns ON.
- For the terminal used for the SLEEP signal, set "70 (positive logic)" or "170 (negative logic)" in **Pr.195 (Output terminal function selection)** to assign the function.

◆ PID monitor function

- This function displays the PID control set point, measured value, and deviation on the operation panel.
- An integral value indicating a negative % can be displayed on the deviation monitor. 0% is displayed as 1000.
- Set a value in Pr.774 to Pr.776 (Operation panel monitor selection) as follows.

Parameter Setting	Monitor description	Minimum increment	Monitor range on the operation panel	Remarks
52	PID set point	0.1%	0 to 100%	"0" is displayed at all times when PID control is based in deviation input.
53	PID measured value	0.1%	0 to 100%	
54	PID deviation	0.1%	Setting not available	When signed indication is invalid, the indicated values are from "900%" to "1100%" on the operation panel. (0% is offset and displayed as "1000%.")

◆ Adjustment procedure

1. Enable PID control
When **Pr.128** ≠ "0", PID control is enabled.
2. Setting the parameter
Adjust the PID control parameters of **Pr.127**, **Pr.129 to Pr.134**, **Pr.575 to Pr.577**.

3. Terminal setting

Set the I/O terminals for PID control. (**Pr.178 to Pr.182 (Input terminal function selection)**, **Pr.195 (Output terminal function selection)**)

4. Turn the X14 signal ON

When the X14 signal is assigned to the input terminal, PID control is enabled by the X14 signal turning ON.

5. Operation

◆ Calibration example

(Adjust room temperature to 25°C by PID control using a detector that outputs 4 mA at 0°C and 20 mA at 50°C.)

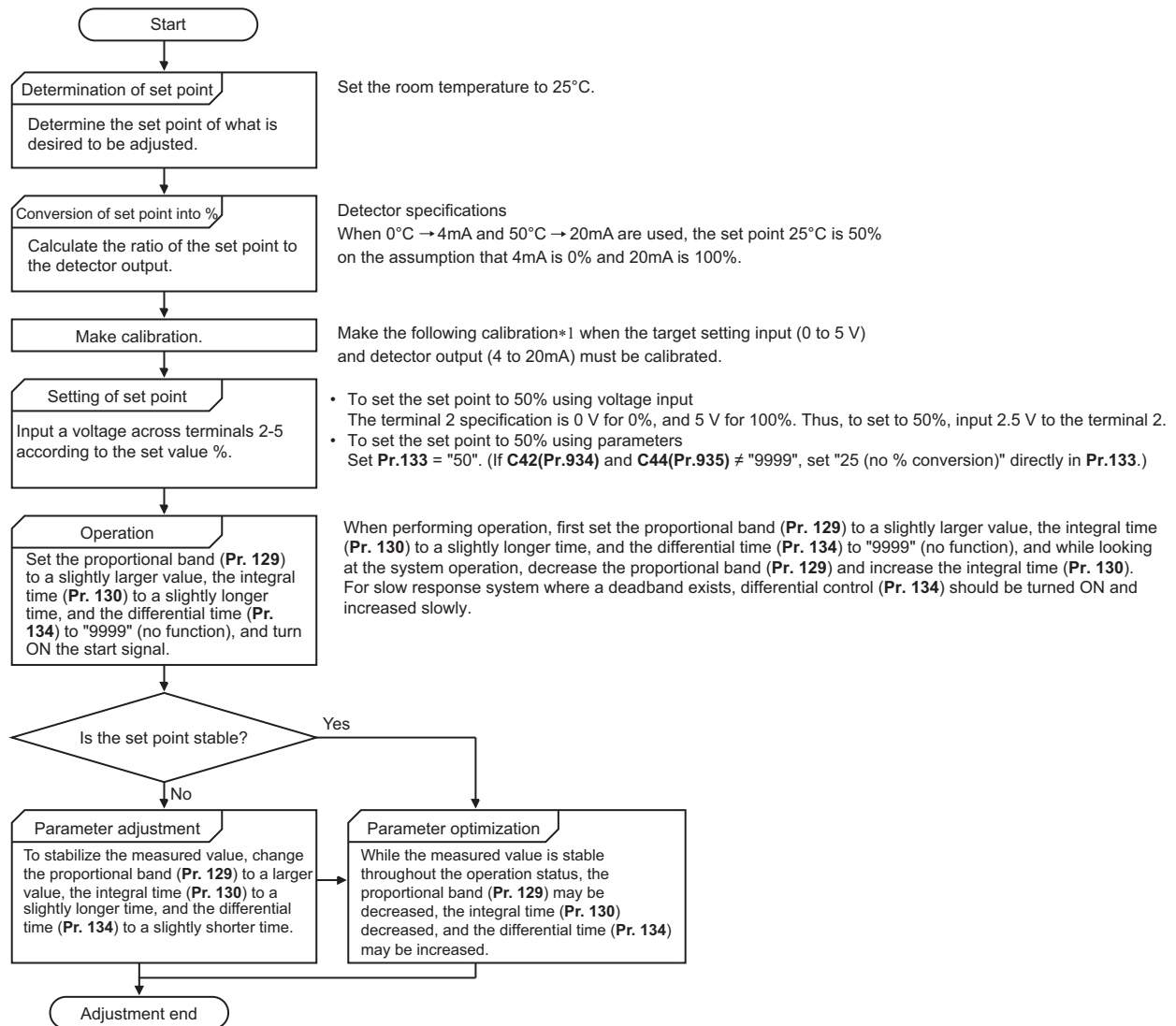

*1 When calibration is required
Calibrate detector output and set point input by Pr.125 and C2 (Pr.902) to C4 (Pr.903) for terminal 2, or **Pr.126 and C5 (Pr.904) to C7 (Pr.905)** for terminal 4. (Refer to [page 134](#).)
Make calibration in the PU operation mode during an inverter stop.

• Calibrating set point input

(Example: To enter the set point on terminal 2)

1. Apply the input (for example, 0 V) of set point setting 0% across terminals 2 and 5.
2. Using **C2 (Pr.902)**, enter the frequency (for example, 0 Hz) to be output by the inverter when the deviation is 0%.
3. Using **C3 (Pr.902)**, set the voltage value at 0%.
4. Apply the input (for example, 5 V) of set point setting 100% across terminals 2 and 5.

5. Using Pr.125, enter the frequency (for example, 60 Hz) to be output by the inverter when the deviation is 100%.
6. Using C4 (Pr.903), set the voltage value at 100%.

NOTE

- When the set point is set at Pr.133, the setting frequency of C2 (Pr.902) is equivalent to 0% and the setting frequency of Pr.125 (Pr.903) is equivalent to 100%.

- Measured value input calibration

1. Apply the input (for example, 4 mA) of measured value 0% across terminals 4 and 5.
2. Perform calibration by C6 (Pr.904).
3. Apply the input (for example, 20 mA) of measured value 100% across terminals 4 and 5.
4. Perform calibration by C7 (Pr.905).

NOTE

- Set the frequencies set at C5 (Pr.904) and Pr.126 to each of the same values set at C2 (Pr.902) and Pr.125.

- The following figure shows the results of having performed the calibration above.

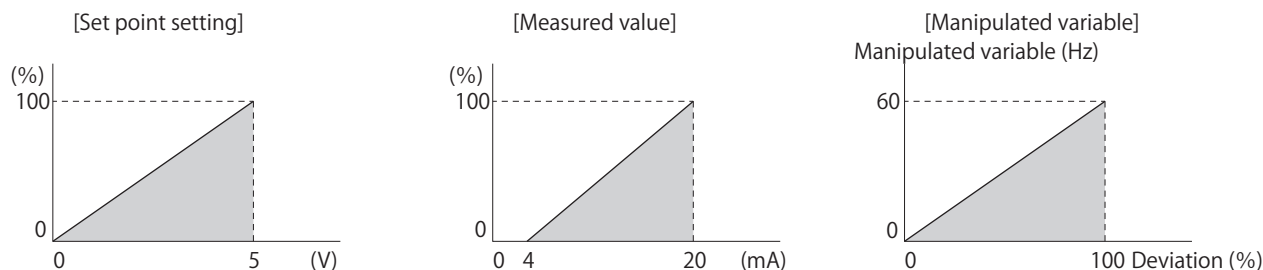

Parameters referred to

- Pr.59 Remote function selection [page 96](#)
- Pr.73 Analog input selection [page 131](#)
- Pr.79 Operation mode selection [page 100](#)
- Pr.178 to Pr.182 (Input terminal function selection) [page 142](#)
- Pr.195 (Output terminal function selection) [page 126](#)
- C2 (Pr.902) to C7 (Pr.905) Frequency setting voltage (current) bias/gain [page 134](#)

5.10.3 Automatic restart after instantaneous power failure

The inverter can be restarted without stopping the motor operation in the following situations:

- When an instantaneous power failure occurs during inverter running
- When the motor is coasting at start

Pr.	Name	Initial value	Setting range	Description
30 E700	Regenerative function selection	0	0, 1	No restart
			2	No restart
57 A702	Restart coasting time	9999	0	Coasting time differs according to the inverter capacity.*1
			0.1 to 30 s	Set the waiting time for the inverter to perform a restart after restoring power due to an instantaneous power failure.
			9999	No restart
58 A703	Restart cushion time	1 s	0 to 60 s	Set the voltage cushion time for restart.
165 A710	Stall prevention operation level for restart	150%	0 to 400%	Set the stall prevention level at restart operation on the assumption that the inverter rated current is 100%.
611 F003	Acceleration time at a restart	9999	0 to 3600 s	Set the acceleration time that takes to reach Pr.20 Acceleration/ deceleration reference frequency setting at a restart.
			9999	Standard acceleration time (for example, Pr.7) is applied as the acceleration time at restart.

*1 The coasting time when **Pr.57** = "0" is as shown below.
 FR-CS84-036 or lower, FR-CS82S-070 or lower: 1 s
 FR-CS84-050 to FR-CS84-160, FR-CS82S-100: 2 s
 FR-CS84-230 or higher: 3 s

Point

- To operate the inverter with the automatic restart after instantaneous power failure function enabled, check the following.
- Set "0" in **Pr.57 Restart coasting time**.

◆ Automatic restart after instantaneous power failure function

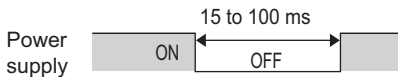

- When the automatic restart after instantaneous power failure function is selected, the motor driving is resumed at power restoration after an instantaneous power failure or undervoltage. (E.UVT is not activated.)

◆ Automatic restart operation of the MRS (X10) signal

- The restart operation after restoration from output shutoff by the MRS (X10) signal is as shown in the following table according to the **Pr.30** setting.

Pr.30 setting	Operation after restoration from output shutoff by the MRS (X10) signal
2	Restart operation (starting from the coasting speed).
Other than the above	Starting from the Pr.13 Starting frequency .

◆ Adjustment of restart coasting time (Pr.57)

- Coasting time is a time period before starting the restart operation.
- To enable restart operation, set "0" in **Pr.57 Restart coasting time**. If "0" is set in **Pr.57**, the coasting time is automatically set to the following value (unit: s). Generally, this setting does not interfere with inverter operation.

Three-phase 400 V class FR-CS84-[-]-60								Single-phase 200 V class FR-CS82S-[-]-60				
012	022	036	050	080	120	160	230	295	025	042	070	100
1	1	1	2	2	2	2	3	3	1	1	1	2

- Inverter operation is sometimes hindered by the size of the moment of inertia (J) of the load or running frequency. Adjust this coasting time within the range 0.1 s to 30 s to match the load specification.

◆ Restart cushion time (Pr.58)

- The cushion time is the time taken to raise the voltage to the level required for the specified speed.

- Normally, the motor runs at the initial value as it is. However, adjust to suit the moment of inertia (J) of the load or the size of the torque.

◆ Adjustment of restart operation (Pr.165, Pr.611)

- The stall prevention operation level at a restart operation can be set in Pr.165.
- Using Pr.611, the acceleration time to reach Pr.20 Acceleration/deceleration reference frequency after a restart operation can be set. This can be set individually from the normal acceleration time.

NOTE

- Changing the terminal assignment using Pr.178 to Pr.182 (Input terminal function selection) may affect the other functions. Set parameters after confirming the function of each terminal.
- The SU and FU signals are not output during the restart. These signals are output after the restart cushion time passes.

Parameters referred to

Pr.7 Acceleration time, Pr.21 Acceleration/deceleration time increments [page 93](#)

Pr.13 Starting frequency [page 99](#)

Pr.65, Pr.67 to Pr.69 (Retry function) [page 115](#)

Pr.78 Reverse rotation prevention selection [page 108](#)

Pr.178 to Pr.182 (Input terminal function selection) [page 142](#)

5.10.4 Power failure time deceleration-to-stop function

At instantaneous power failure or undervoltage, the motor can be decelerated to a stop or to the set frequency for the re-acceleration.

Pr.	Name	Initial value	Setting range	Description
261 A730	Power failure stop selection	0	0	Power failure time deceleration-to-stop function disabled
			1, 2	Power failure time deceleration-to-stop function enabled Select action at an undervoltage or when a power failure occurs.

◆ Action setting at undervoltage and power failure

- Set Pr.261 to select the action at an undervoltage and power failure.

Pr.261 setting	Action at undervoltage and power failure	Power restoration during deceleration at occurrence of power failure
0	Output shutoff	—
1	Output is controlled to decelerate the motor to a stop.	Output is controlled to decelerate the motor to a stop.
2		Re-acceleration

◆ Power failure stop function (Pr.261 = "1")

- Even if power is restored during deceleration triggered by a power failure, deceleration stop is continued after which the inverter stays stopped. To restart operation, turn the start signal OFF then ON again.

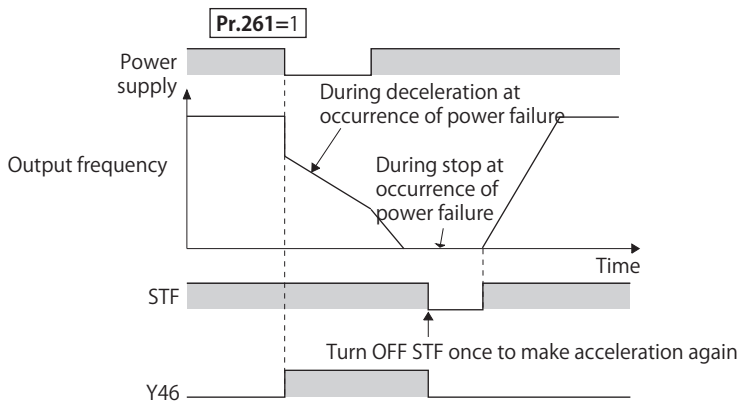

NOTE

- If the automatic restart after instantaneous power failure is selected (**Pr.57 Restart coasting time** ≠ "9999") while the power failure time deceleration-to-stop function is set enabled (**Pr.261** = "1"), the power failure time deceleration stop function is disabled.
- When the power failure time deceleration-to-stop function is enabled (**Pr.261** = "1"), the inverter does not start even if the power is turned ON or inverter reset is performed with the start signal (STF/STR) ON. Turn OFF the start signal once and then ON again to make a start.

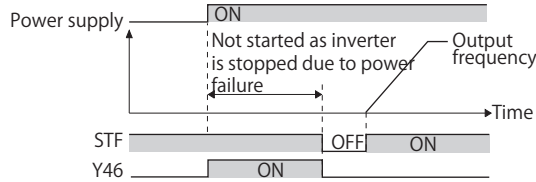

◆ Continuous operation function at instantaneous power failure (Pr.261 = "2")

- The motor re-accelerates to the set frequency if the power restores during deceleration triggered by a power failure.
- Combining with the automatic restart after instantaneous power failure function enables deceleration at a power failure and re-acceleration at a power restoration.

If the power is restored after stoppage by a power failure, a restart operation is performed when automatic restart after instantaneous power failure (**Pr.57** ≠ "9999") is selected.

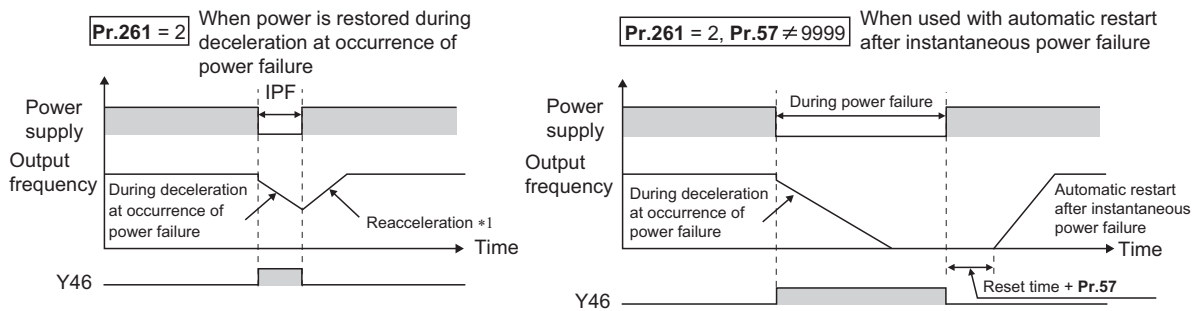

*1 The acceleration time depends on **Pr.7 (Pr.44)**.

◆ During deceleration at occurrence of power failure (Y46) signal

- After deceleration by a power failure, the inverter does not restart even though the start command is input. Check the During deceleration at occurrence of power failure (Y46) signal at a power failure.
- The Y46 signal is turned ON during deceleration at occurrence of power failure and in a stop status after deceleration at occurrence of power failure.
- For the Y46 signal, set "46 (positive logic)" or "146 (negative logic)" in **Pr.195 (Output terminal function selection)** to assign the function.

NOTE

- When "2" is set to Pr.30 Regenerative function selection (when the FR-HC2 or FR-CV is used), the power failure time deceleration-to-stop function is disabled at a power failure.
- The power failure time stop function is disabled during a stop or when the breaker is tripped.
- The Y46 signal turns ON if an undervoltage occurs even when a deceleration at a power failure has not occurred. For this reason, the Y46 signal is sometimes output instantaneously when the power supply is turned OFF. This is not a fault.
- When the power failure time deceleration stop function is selected, undervoltage protection (E.UVT) is invalid.
- Changing the terminal assignment using **Pr.178 to Pr.182 (Input terminal function selection)** or **Pr.195 (Output terminal function selection)** may affect other functions. Set parameters after confirming the function of each terminal.

CAUTION

- Even if the power failure time deceleration stop function is set, some loads might cause the inverter to trip and the motor to coast.

The motor coasts if sufficient regenerative power is not obtained from the motor.

«Parameters referred to»

Pr.20 Acceleration/deceleration reference frequency  [page 93](#)

Pr.30 Regenerative function selection  [page 159](#)

Pr.57 Restart coasting time  [page 159](#)

Pr.195 (Output terminal function selection)  [page 126](#)

5.11 (N) Communication operation parameters

Purpose	Parameter to set			Refer to page
To start operation via communication	Initial setting of operation via communication	P.N000, P.N001, P.N013	Pr.549, Pr.342, Pr.502	165
To communicate via PU connector	Initial setting of computer link communication (PU connector)	P.N020 to P.N028	Pr.117 to Pr.124	168

5.11.1 Wiring and configuration of PU connector

Using the PU connector as a computer network port enables communication operation from a personal computer, etc. When the PU connector is connected with a personal, FA, or other computer by a communication cable, a user program can run and monitor the inverter or read and write to parameters.

◆ PU connector pin-outs

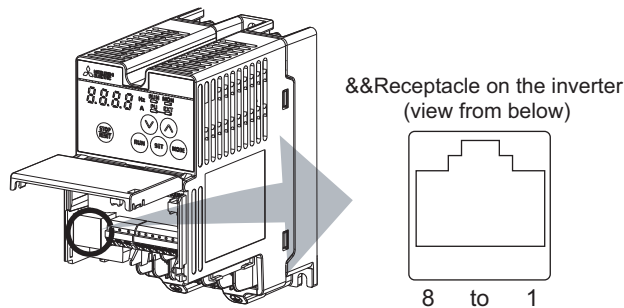

Pin number	Name	Description
1	SG	Earth (ground) (connected to terminal 5)
2	—	PU power supply
3	RDA	Inverter receive+
4	SDB	Inverter send-
5	SDA	Inverter send+
6	RDB	Inverter receive-
7	SG	Earth (ground) (connected to terminal 5)
8	—	PU power supply

NOTE

- Pins No. 2 and 8 provide power to the PU. Do not use these pins for RS-485 communication.
- Do not connect the PU connector to the computer's LAN board, FAX modem socket, or telephone modular connector. The product could be damaged due to differences in electrical specifications.

◆ Wiring and configuration of PU connector communication system

- Computer and inverter connection (1:1)

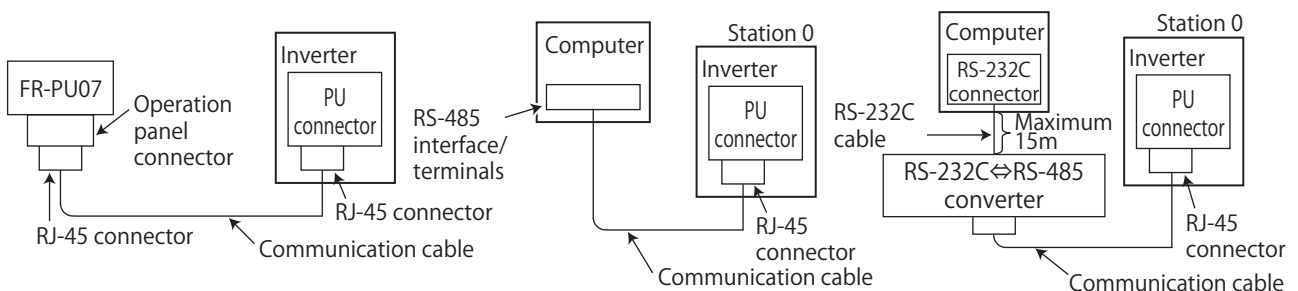

- Combination of a computer and multiple inverters (1:n)

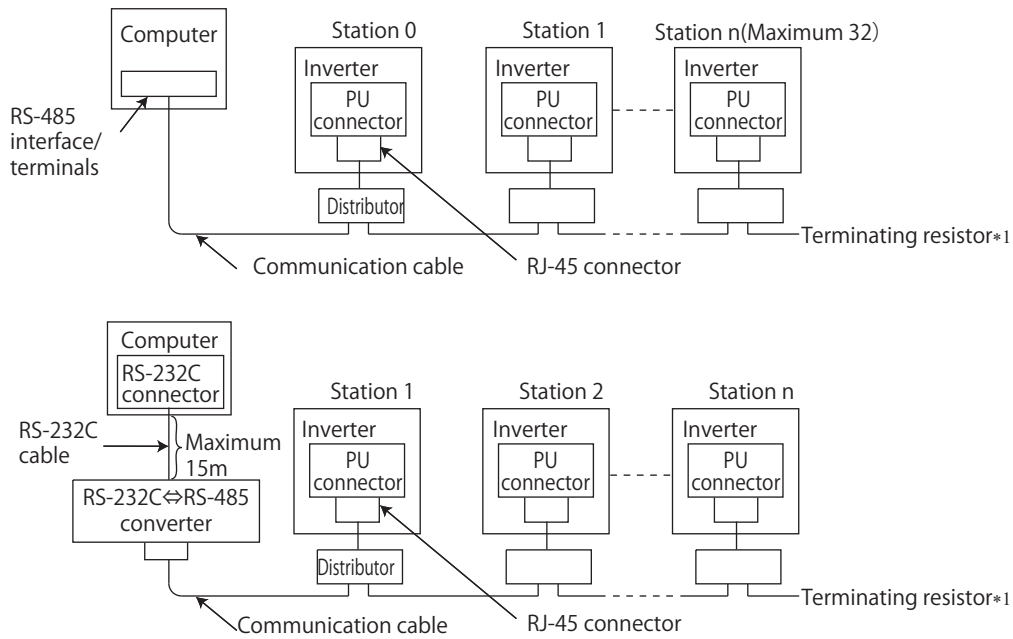

*1 The inverters may be affected by reflection depending on the transmission speed or transmission distance. If this reflection hinders communication, provide a terminating resistor. If the PU connector is used to make a connection, use a distributor since a terminating resistor cannot be fitted. Connect the terminating resistor to only the inverter remotest from the computer. (Terminating resistor: 100 W)

NOTE

- Computer-inverter connection cable
Refer to the following for the connection cable (RS-232C to RS-485 converter) between the computer with an RS-232C interface and an inverter. Commercially available products (as of February 2015)

Model	Manufacturer
Interface embedded cable DAFXIH-CAB (D-SUB25P for personal computer) DAFXIH-CABV (D-SUB9P for personal computer) + Connector conversion cable DINV-485CAB (for inverter)*2	Diatrend Corp.
Interface embedded cable dedicated for inverter DINV-CABV*2	

*2 The conversion cable cannot connect multiple inverters. (The computer and inverter are connected in a 1:1 pair.) This product is an RS-232C to RS-485 conversion cable that has a built-in converter. No additional cable or connector is required. For the product details, contact the manufacturer.

- Refer to the following table when fabricating the cable on the user side.
Commercially available products (as of February 2015)

Product name	Model	Manufacturer
Communication cable	SGLPEV-T (Cat5e/300 m) 24AWG × 4P*3	Mitsubishi Cable Industries, Ltd.
RJ-45 connector	5-554720-3	Tyco Electronics

*3 Do not use pins No. 2 and 8 of the communication cable.

◆ Wiring between a computer and an inverter for RS-485 communication

- Wiring between a computer and an inverter for RS-485 communications

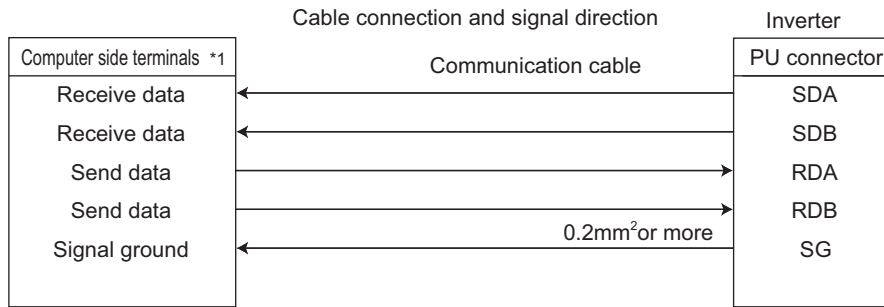

- Wiring between a computer and multiple inverters for RS-485 communication

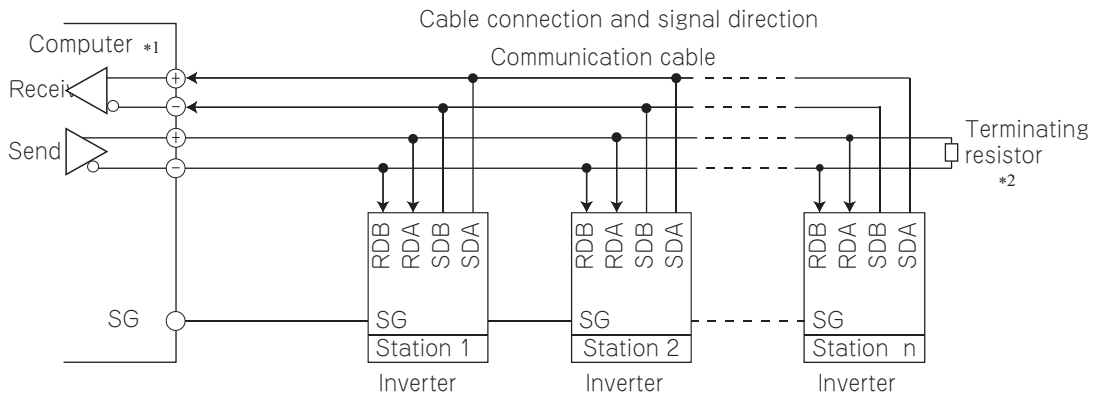

*1 Make connection in accordance with the Instruction Manual of the computer to be used with. Fully check the terminal numbers of the computer since they vary with the model.

*2 The inverters may be affected by reflection depending on the transmission speed or transmission distance. If this reflection hinders communication, provide a terminating resistor. If the PU connector is used to make a connection, use a distributor since a terminating resistor cannot be fitted. Connect the terminating resistor to only the inverter remotest from the computer. (Terminating resistor: 100 W)

◆ Two-wire type connection

If the computer is 2-wire type, a connection from the inverter can be changed to 2-wire type by installing jumper wires between the reception pins and transmission pins of the PU connector.

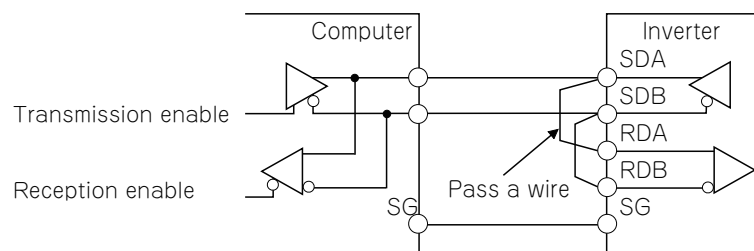

NOTE

- A program should be created so that transmission is disabled (receiving state) when the computer is not sending and reception is disabled (sending state) during sending to prevent the computer from receiving its own data.
- The jumper wires should be as short as possible.

5.11.2 Initial setting of operation via communication

Set the action when the inverter is performing operation via communication.

- Set the RS-485 communication protocol. (Mitsubishi inverter protocol / MODBUS RTU protocol)
- Set the action at fault occurrence or at writing of parameters.

Pr.	Name	Initial value	Setting range	Description	
549 N000	Protocol selection	0	0	Mitsubishi inverter protocol (computer link)	
			1	MODBUS RTU protocol	
342 N001	Communication EEPROM write selection	0	0	Parameter values written by communication are written to the EEPROM and RAM.	
			1	Parameter values written by communication are written to the RAM.	
502 N013	Stop mode selection at communication error	0	0	Inverter operation when a communication error occurs	Inverter operation after a communication error is cleared
				Output shutoff ALM signal output	Output stop status continues.
			1	Output to decelerate and stop the motor ALM signal output after stop	Output stop status continues.
			2	Output to decelerate and stop the motor	Restart

◆ Communication EEPROM write selection (Pr.342)

- The parameters storage device can be changed from EEPROM and RAM to RAM only for parameter write performed via the inverter's PU connector. Use this function if parameter settings are changed frequently.
- When it is desired to change the parameter values frequently, set "1" in Pr.342 Communication EEPROM write selection to write the values to the RAM only. The life of the EEPROM will be shorter if parameter write is performed frequently with the setting unchanged from "0 (initial value)" (EEPROM write).

NOTE

- Turning OFF the inverter's power supply clears the modified parameter settings when Pr.342 = "1 (write only to RAM)". Therefore, the parameter values at next power-ON are the values last stored in EEPROM.
- The parameter setting written in RAM cannot be checked on the operation panel. (The values displayed on the operation panel are the ones stored in EEPROM.)

◆ Operation selection at a communication error (Pr.502)

- You can select the inverter operation when a communication line error occurs during communication through the PU connector. The operation is active under the Network operation mode.
- Select the stop operation at the retry count excess (Pr.335, enabled only when the Mitsubishi inverter protocol is selected) or at a signal loss detection (Pr.336, Pr.539).

Fault type	Pr.502 setting	At fault occurrence			At fault removal		
		Operation	Indication	Fault (ALM) signal	Operation	Indication	Fault (ALM) signal
Communication line	0 (initial value)	Output shutoff	"E.PUE"	ON	Output stop status continues.	"E.PUE" remains displayed.	ON
	1	Output to decelerate and stop the motor	"E.PUE"	ON after stop			
	2		OFF	Restart	Normal	OFF	

- The following charts show operations when a communication line error occurs.

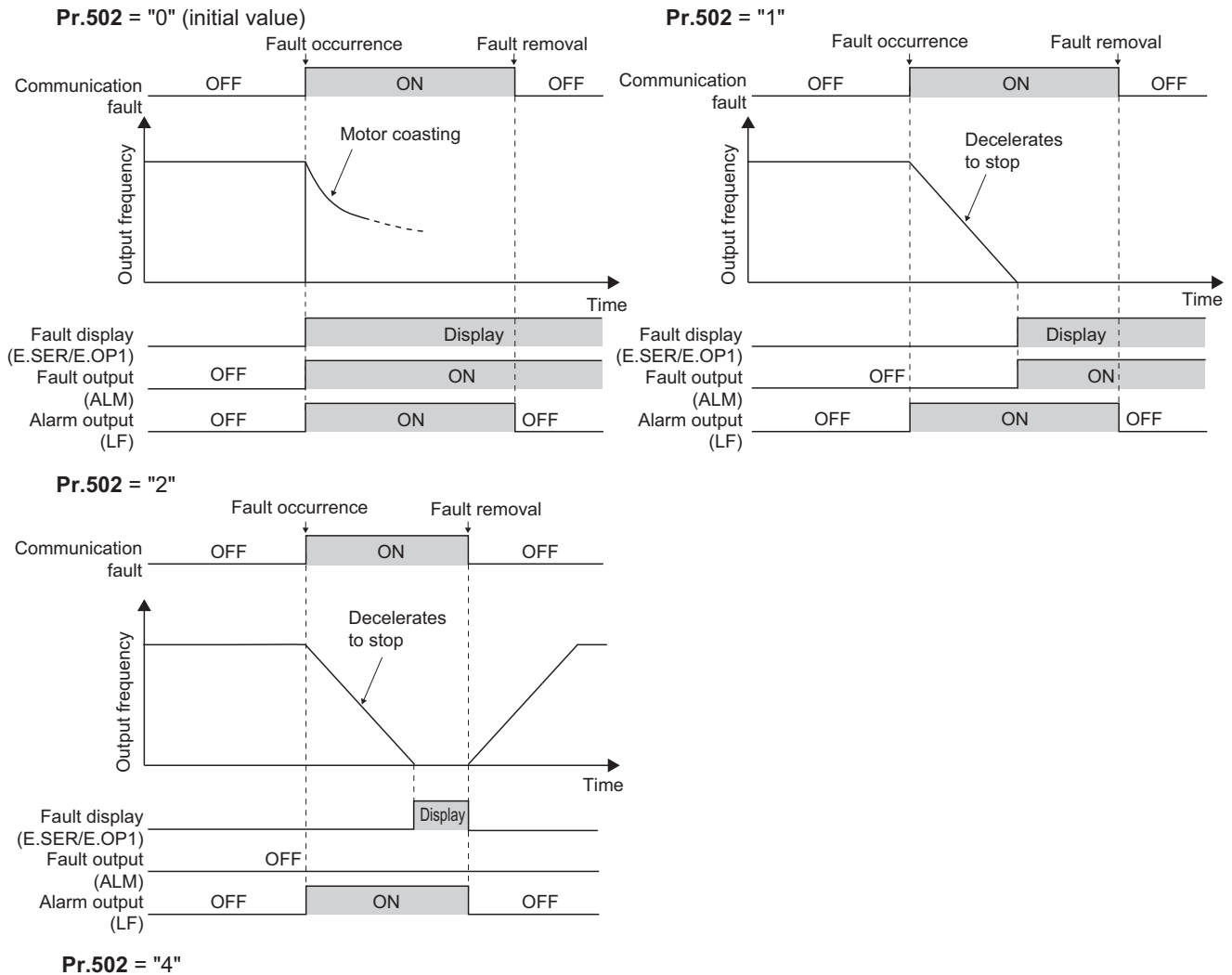

NOTE

- Fault output indicates the Fault (ALM) signal and an alarm bit output.
- When the fault output is set enabled, fault records are stored in the faults history. (A fault record is written to the faults history at a fault output.)
- When the fault output is not enabled, fault record is overwritten to the faults history temporarily but not stored.
- After the fault is removed, the fault indication goes back to normal indication on the monitor, and the faults history goes back to the previous status.
- When **Pr.502** ≠ "0", the normal deceleration time setting (settings like **Pr.8**, **Pr.44**, and **Pr.45**) is applied as the deceleration time. Normal acceleration time setting (settings like **Pr.7** and **Pr.44**) is applied as the acceleration time for restart.
- When **Pr.502** = "2", the inverter operates with the start command and the speed command, which were used before the fault.
- If a communication line error occurs, then the error is removed during deceleration while **Pr.502** = "2", the motor re-accelerates from that point.

◆ Operation mode switching and communication startup mode (Pr.79, Pr.340)

- Check the following before switching the operation mode.

The inverter is at a stop.

Both the STF and STR signals are off.

Check that the **Pr.79 Operation mode selection** setting is correct. (Check the setting on the PU of the inverter.) (Refer to [page 100](#).)

- The operation mode at power ON and at restoration from instantaneous power failure can be selected. Set a value other than "0" in **Pr.340 Communication startup mode selection** to select the Network operation mode. (Refer to [page 104](#).)
- After the inverter starts up in the Network operation mode, parameter write can be commanded via the network.

NOTE

- The changed value in **Pr.340** is applied after the next power-ON or inverter reset.
- The **Pr.340** setting can be changed on the PU in any operation mode.
- When setting a value other than "0" in **Pr.340**, make sure that the communication settings of the inverter are correct.

Parameters referred to

Pr.7 Acceleration time, Pr.8 Deceleration time [page 93](#)

Pr.79 Operation mode selection [page 100](#)

Pr.340 Communication startup mode selection [page 104](#)

Pr.551 PU mode operation command source selection [page 105](#)

5.11.3 Initial settings and specifications of RS-485 communication

Use the following parameters to perform required settings for RS-485 communication between the inverter and a personal computer.

- Communication is available through the PU connector on the inverter.
- Parameter setting, monitoring, etc. can be performed using Mitsubishi inverter protocol or MODBUS RTU communication protocol.
- To make communication between the personal computer and inverter, setting of the communication specifications must be made to the inverter in advance. Data communication cannot be made if the initial settings are not made or if there is any setting error.

◆ Parameters related to PU connector communication

Pr.	Name	Initial value	Setting range	Description	
117 N020	PU communication station number	0	0 to 31	Specify the inverter station number. Enter the inverter station numbers when two or more inverters are connected to one personal computer.	
118 N021	PU communication speed	192	48, 96, 192, 384, 576, 768, 1152	Select the communication speed. The setting value × 100 equals the communication speed. For example, enter 192 to set the communication speed of 19200 bps.	
N022	PU communication data length	0	0 1	Data length 8 bits Data length 7 bits	
N023	PU communication stop bit length	1	0 1	Stop bit length 1 bit Stop bit length 2 bits	
119	PU communication stop bit length / data length	1	0	Stop bit length 1 bit	Data length 8 bits
			1	Stop bit length 2 bits	
			10	Stop bit length 1 bit	Data length 7 bits
			11	Stop bit length 2 bits	
120 N024	PU communication parity check	2	0	Without parity check	
			1	With parity check at odd numbers	
			2	With parity check at even numbers	
121 N025	PU communication retry count	1	0 to 10	Set the permissible number of retries for unsuccessful data reception. If the number of consecutive errors exceeds the permissible value, the inverter output will be stopped.	
			9999	The inverter output will not be shut off even when a communication error occurs.	
122 N026	PU communication check time interval	9999	0	PU connector communication is disabled.	
			0.1 to 999.8 s	Set the interval of the communication check (signal loss detection) time If a no-communication state persists for longer than the permissible time, the inverter output will be shut off.	
			9999	No communication check (signal loss detection)	
123 N027	PU communication waiting time setting	9999	0 to 150 ms	Set the waiting time between data transmission to the inverter and the response.	
			9999	Set with communication data. Waiting time: setting data × 10 ms	
124 N028	PU communication CR/LF selection	1	0	Without CR/LF	
			1	With CR	
			2	With CR/LF	

NOTE

- Always reset the inverter after making the initial settings of the parameters. After changing the communication-related parameters, communication cannot be made until the inverter is reset.

5.11.4 Mitsubishi inverter protocol (computer link communication)

Parameter setting and monitoring, etc. are possible by using the Mitsubishi inverter protocol (computer link communication) via the PU connector on the inverter.

◆ Communication specifications

- The communication specifications are given below.

Item	Description	Related parameter	
Communication protocol	Mitsubishi protocol (computer link)	Pr.551	
Conforming standard	EIA-485 (RS-485)	—	
Number of connectable units	1: N (maximum 32 units), the setting range of station number is 0 to 31.	Pr.117	
Communication speed	PU connector Selected among 4800/9600/19200/38400/57600/76800/115200 bps	Pr.118	
Control procedure	Asynchronous method	—	
Communication method	Half-duplex system	—	
Communication specifications	Character system	ASCII (7 bits or 8 bits can be selected.)	Pr.119
	Start bit	1 bit	—
	Stop bit length	1 bit or 2 bits can be selected.	Pr.119
	Parity check	Check (at even or odd numbers) or no check can be selected.	Pr.120
	Error check	Sum code check	—
Terminator	CR/LF (whether or not to use it can be selected)	Pr.124	
Time delay setting	Availability of the setting is selectable.	Pr.123	

◆ Communication procedure

- Data communication between the computer and inverter is made in the following procedure.
 - Request data is sent from the computer to the inverter. (The inverter will not send data unless requested.)
 - Communication waiting time
 - The inverter sends reply data to the computer in response to the computer request.
 - Inverter data processing time
 - An answer from the computer in response to reply data (c) of the inverter is transmitted. (Even if (e) is not sent, subsequent communication is made properly.)

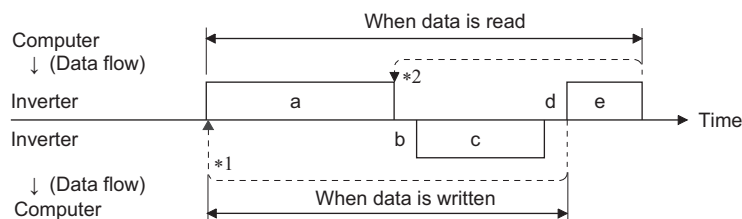

- *1 If a data error is detected and a retry must be made, perform retry operation with the user program. The inverter output is shut off if the number of consecutive retries exceeds the parameter setting.
- *2 On receipt of a data error occurrence, the inverter returns reply data (c) to the computer again. The inverter output is shut off if the number of consecutive data errors reaches or exceeds the parameter setting.

◆ Communication operation presence/absence and data format types

- Data communication between the computer and inverter is made in ASCII code (hexadecimal code).

- Communication operation presence/absence and data format types are as follows.

Symbol	Operation	Operation command	Operation frequency	Multi command	Parameter write	Inverter reset	Monitor	Parameter read	
a	Communication request is sent to the inverter in accordance with the user program in the computer.	A, A1	A	A2	A	A	B	B	
b	Inverter data processing time	With	With	With	With	Without	With	With	
c	Reply data from the inverter (Data (a) is checked for an error.)	No error ^{*1} (Request accepted)	C	C	C1 ^{*3}	C	C ^{*2}	E, E1, E2, E3	E
		With error (Request rejected)	D	D	D	D	D ^{*2}	D	D
d	Computer processing delay time	10 ms or more							
e	Reply from computer in response to reply data c (Data c is checked for error.)	No error ^{*1} (No inverter processing)	Without	Without	Without (C)	Without	Without	Without (C)	Without (C)
		With error (Inverter outputs c again.)	Without	Without	F	Without	Without	F	F

*1 In the communication request data from the computer to the inverter, 10 ms or more is also required after "no data error (ACK)". (Refer to page 174.)

*2 Reply from the inverter to the inverter reset request can be selected. (Refer to page 179.)

*3 At mode error and data range error, C1 data contains an error code. Except for those errors, the error is returned with data format D.

- Data writing format

a. Communication request data from the computer to the inverter

Format	Number of characters																		
	1	2	3	4	5	6	7	8	9	10	11	12	13	14	15	16	17	18	19
A	ENQ ^{*1}	Inverter station number ^{*2}	Instruction code			^{*3}	Data				Sum check		^{*4}						
A1	ENQ ^{*1}	Inverter station number ^{*2}	Instruction code			^{*3}	Data		Sum check		^{*4}								
A2	ENQ ^{*1}	Inverter station number ^{*2}	Instruction code			^{*3}	Send data type	Receive data type	Data 1			Data 2			Sum check		^{*4}		

c. Reply data from the inverter to the computer (No data error detected)

Format	Number of characters																		
	1	2	3	4	5	6	7	8	9	10	11	12	13	14	15	16	17	18	19
C	ACK ^{*1}	Inverter station number ^{*2}		^{*4}															
C1	STX ^{*1}	Inverter station number ^{*2}	Send data type	Receive data type	Error code 1	Error code 2	Data 1				Data 2			ETX ^{*1}	Sum check		^{*4}		

c. Reply data from the inverter to the computer (Data error detected)

Format	Number of characters				
	1	2	3	4	5
D	NAK ^{*1}	Inverter station number ^{*2}		Error code	^{*4}

*1 Indicates a control code.

*2 Specifies the inverter station numbers in the range of H00 to H1F (stations 0 to 31) in hexadecimal.

*3 When Pr.123 (time delay setting) ≠ 9999, create a communication request data without time delay in the data format. (The number of characters decreases by 1.)

*4 CR/LF code: When data is transmitted from the computer to the inverter, codes CR (carriage return) and LF (line feed) are automatically set at the end of a data group on some computers. In this case, setting must be also made on the inverter according to the computer. Whether the CR and LF codes will be present or absent can be selected using Pr.124 or Pr.341 (CR/LF selection).

- Data reading format

a. Communication request data from the computer to the inverter

Format	Number of characters								
	1	2	3	4	5	6	7	8	9
B	ENQ ^{*1}	Inverter station number ^{*2}		Instruction code ^{*3}		Sum check		*4	

c. Reply data from the inverter to the computer (No data error detected)

Format	Number of characters													
	1	2	3	4	5	6	7	8	9	10	11	12	13	
E	STX ^{*1}	Inverter station number ^{*2}		Read data				ETX ^{*1}	Sum check		*4			
E1	STX ^{*1}	Inverter station number ^{*2}		Read data		ETX ^{*1}	Sum check		*4					
E2	STX ^{*1}	Inverter station number ^{*2}		Read data						ETX ^{*1}	Sum check		*4	

Format	Number of characters														
	1	2	3	4 to 23							24	25	26	27	
E3	STX ^{*1}	Inverter station number ^{*2}		Read data (Inverter model information)							ETX ^{*1}	Sum check		*4	

c. Reply data from the inverter to the computer (Data error detected)

Format	Number of characters				
	1	2	3	4	5
D	NAK ^{*1}	Inverter station number ^{*2}		Error code	*4

e. Transmission data from the computer to the inverter when reading data

Format	Number of characters			
	1	2	3	4
C (No data error detected)	ACK ^{*1}	Inverter station number ^{*2}		*4
F (Data error detected)	NAK ^{*1}	Inverter station number ^{*2}		*4

*1 Indicates a control code.

*2 Specifies the inverter station numbers in the range of H00 to H1F (stations 0 to 31) in hexadecimal.

*3 Set the delay time. When Pr.123 (time delay setting) ≠ 9999, create a communication request data without time delay in the data format. (The number of characters decreases by 1.)

*4 CR/LF code: When data is transmitted from the computer to the inverter, codes CR (carriage return) and LF (line feed) are automatically set at the end of a data group on some computers. In this case, setting must be also made on the inverter according to the computer. Whether the CR and LF codes will be present or absent can be selected using **Pr.124** or **Pr.341** (CR/LF selection).

◆ Data definitions

- Control code

Signal name	ASCII code	Description
STX	H02	Start Of Text (Start of data)
ETX	H03	End Of Text (End of data)
ENQ	H05	Enquiry (Communication request)
ACK	H06	Acknowledge (No data error detected)
LF	H0A	Line Feed
CR	H0D	Carriage Return
NAK	H15	Negative Acknowledge (Data error detected)

- Inverter station number

Specify the station number of the inverter which communicates with the computer.

- Instruction code

Specify the processing request, for example, operation or monitoring, given by the computer to the inverter. Hence, the inverter can be run and monitored in various ways by specifying the instruction code appropriately. (Refer to [page 179](#).)

• Data

Indicates the data such as frequency and parameters transferred to and from the inverter. The definitions and ranges of set data are determined in accordance with the instruction codes. (Refer to page 179.)

• Waiting time

Specify the waiting time between the receipt of data at the inverter from the computer and the transmission of reply data. Set the waiting time in accordance with the response time of the computer in the range of 0 to 150 ms in 10 ms increments. (For example; 1 = 10 ms, 2 = 20 ms)

When Pr.123 (time delay setting) ≠ 9999, create a communication request data without time delay in the data format. (The number of characters decreases by 1.)

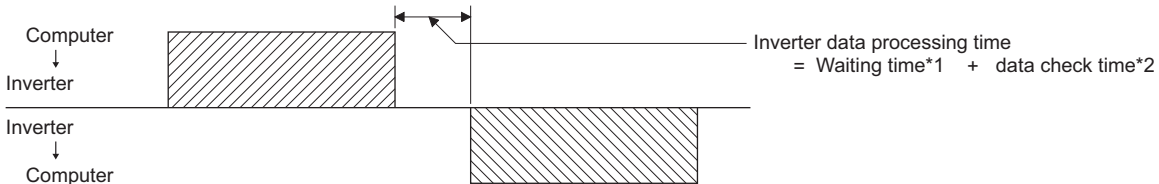

- *1 When Pr.123 = "9999", the time delay (in milliseconds) is the data setting value multiplied by 10. When Pr.123 ≠ "9999", the time delay is the value set in Pr.123.
- *2 The time is about 10 to 30 ms. It varies depending on the instruction code.

NOTE

- The data check time varies depending on the instruction code. (Refer to page 174.)

• Sum check code

The sum check code is a 2-digit ASCII (hexadecimal) representing the lower 1 byte (8 bits) of the sum derived from the checked ASCII data.

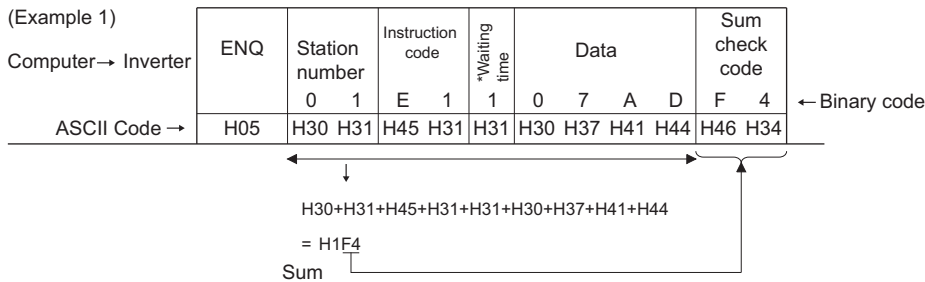

*When the Pr.123 or Pr.337 (Waiting time setting) ≠ 9999, create the communication request data without "waiting time" in the data format. (The number of characters decreases by 1.)

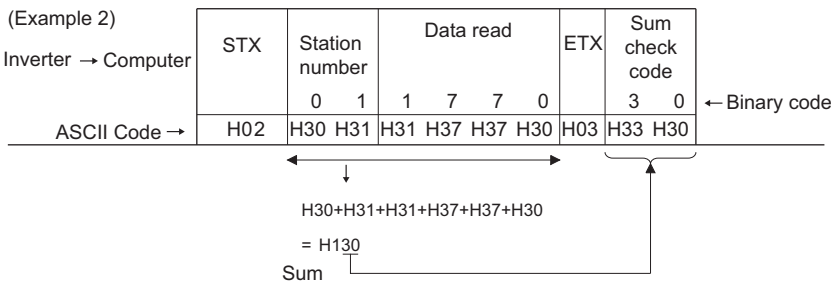

• Error code

If any error is found in the data received by the inverter, its error definition is sent back to the computer together with the

NAK code.

Error code	Error item	Error description	Inverter operation
H0	Computer NAK error	The number of errors consecutively detected in communication request data from the computer is greater than the permissible number of retries.	If errors occur consecutively and exceed the number of the permissible number of retries, the inverter output will be shut off (E.PUE). The LF signal is output.
H1	Parity error	The parity check result does not match the specified parity.	
H2	Sum check error	The sum check code in the computer does not match that of the data received by the inverter.	
H3	Protocol error	The data received by the inverter has a grammatical mistake. Or, data receive is not completed within the predetermined time. CR or LF is not as set in the parameter.	
H4	Framing error	The stop bit length differs from the initial setting.	
H5	Overrun error	New data has been sent by the computer before the inverter completes receiving the preceding data.	
H6	—	—	—
H7	Character error	The character received is invalid (other than 0 to 9, A to F, control code).	The inverter does not accept the received data. However, the inverter output is not shut off.
H8	—	—	—
H9	—	—	—
HA	Mode error	Parameter write was attempted in other than the computer link operation mode, when operation command source is not selected or during Inverter operation.	The inverter does not accept the received data. However, the inverter output is not shut off.
HB	Instruction code error	The specified instruction code does not exist.	
HC	Data range error	Invalid data has been specified for parameter writing, running frequency setting, etc.	
HD	—	—	—
HE	—	—	—
HF	Normal (no error)	—	—

◆ Response time

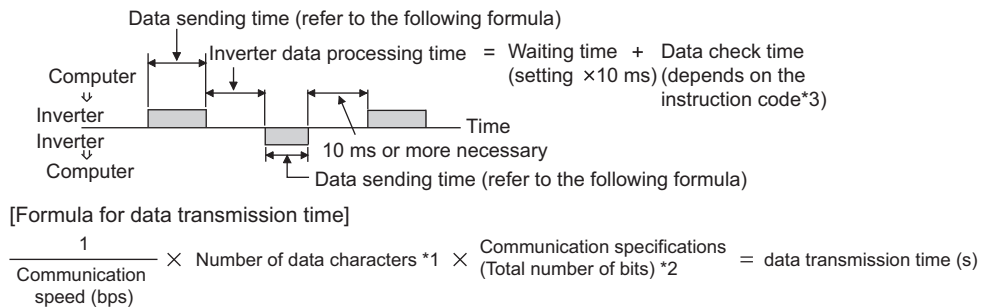

*1 Refer to [page 170](#).

*2 Communication specifications

Name	Number of bits
Stop bit length	1 bit
	2 bits
Data length	7 bits
	8 bits
Parity check	With 1 bit
	Without 0

In addition to the above, 1 start bit is necessary.

Minimum number of total bits: 9 bits

Maximum number of total bits: 12 bits

*3 Data check time

Item	Check time
Monitoring, operation command, frequency setting (RAM)	Less than 12 ms
Parameter read/write, frequency setting (EEPROM)	Less than 30 ms
Parameter clear / All parameter clear	Less than 5 s
Reset command	No reply

◆ Retry count setting (Pr.121, Pr.335)

- Set the permissible number of retries at data receive error occurrence. (Refer to [page 173](#) for data receive error for retry.)
- When the data receive errors occur consecutively and the number of retries exceeds the permissible number setting, a communication fault (PU connector communication: E.PUE) occurs and the inverter output is shut off.
- When a data transmission error occurs while "9999" is set, the inverter does not shut off power output and outputs the Alarm (LF) signal. To use the LF signal, set "98 (positive logic) or 198 (negative logic)" in **Pr.195 (Output terminal function selection)** to assign the function to an output terminal.

Example: PU connector communication, Pr. 121 = "1" (initial value)

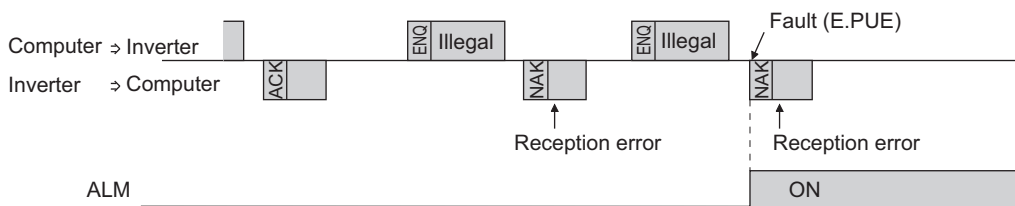

Example: PU connector communication, Pr. 121 = "9999"

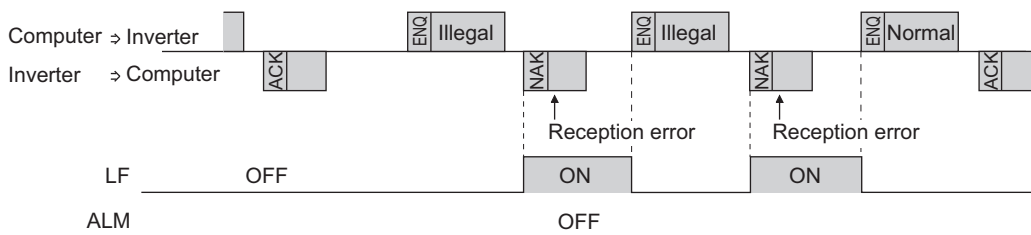

◆ Signal loss detection (Pr.122)

- If a signal loss (communication stop) is detected between the inverter and computer as a result of a signal loss detection, a communication error (E.PUE) occurs and the inverter output will be shut off.
- The LF signal is not output when a signal loss is detected.
- When the setting is "9999", communication check (signal loss detection) is not made.
- When the setting is "0", communication through the PU connector is not possible.
- A signal loss detection is made when the setting is any of "0.1 s to 999.8 s". To make a signal loss detection, it is necessary to send data (for details on control codes, refer to [page 172](#)) from the computer within the communication check time interval. (The inverter makes a communication check (clearing of communication check counter) regardless of the station number setting of the data sent from the master).
- For communication via the PU connector, communication check is started at the first communication in the PU operation mode.

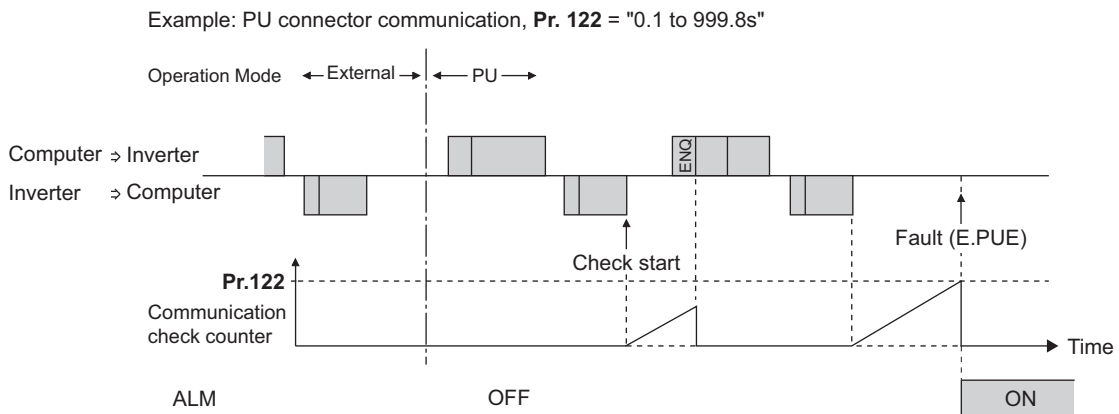

◆ Programming instructions

- When data from the computer has any error, the inverter does not accept that data. Hence, in the user program, always insert a retry program for data error.
- All data communication, for example, run command or monitoring, are started when the computer gives a communication request. The inverter does not return any data without the computer's request. Hence, design the program so that the computer gives a data read request for monitoring, etc. as required.
- Program example: To switch to the Network operation mode

```

#include <stdio.h>
#include <windows.h>

void main(void){
    HANDLE          hCom;          // Communication handle
    DCB             hDcb;         // Structure for setting communication settings
    COMMTIMEOUTS   hTim;         // Structure for setting timeouts

    char           szTx[0x10];    // Send buffer
    char           szRx[0x10];    // Receive buffer
    char           szCommand[0x10]; // Command
    int            nTx,nRx;       // For storing buffer size
    int            nSum;          // For calculating sum code
    BOOL           bRet;
    int            nRet;
    int            i;

    // **** Open COM1 port ****
    hCom = CreateFile("COM1", (GENERIC_READ | GENERIC_WRITE), 0, NULL, OPEN_EXISTING, FILE_ATTRIBUTE_NORMAL, NULL);
    if(hCom != NULL) {
        // **** Set COM1 port communication ****
        GetCommState(hCom,&hDcb); // Get current communication information
        hDcb.DCBLength = sizeof(DCB); // Structure size setting
        hDcb.BaudRate = 19200; // Communication speed = 19200 bps
        hDcb.ByteSize = 8; // Data length = 8 bits
        hDcb.Parity = 2; // Parity check at even numbers
        hDcb.StopBits = 2; // Stop bit = 2 bits
        bRet = SetCommState(hCom,&hDcb); // Setting of changed communication information
        if(bRet == TRUE) {
            // **** Set COM1 port timeout ****
            GetCommTimeouts(hCom,&hTim); // Get current timeout values
            hTim.WriteTotalTimeoutConstant = 1000; // Write timeout 1 second
            hTim.ReadTotalTimeoutConstant = 1000; // Read timeout 1 second
            hTim.ReadTotalTimeoutConstantSetCommTimeouts(hCom,&hTim); // Setting of changed timeout values
            // **** Setting of command for switching the station number 1 inverter to the Network operation mode ****
            sprintf(szCommand,"01FB10000"); // Send data (NET operation write)
            nTx = strlen(szCommand); // Send data size
            // **** Generate sum code ****
            nSum = 0; // Initialize sum data
            for(i = 0; i < nTx; i++) {
                nSum += szCommand[i]; // Calculate sum code
                nSum &= (0xff); // Mask data
            }

            // **** Generate send data ****
            memset(szTx,0,sizeof(szTx)); // Initialize send buffer
            memset(szRx,0,sizeof(szRx)); // Initialize receive buffer
            sprintf(szTx,"%5s%02X",szCommand,nSum); // ENQ code + send data + sum code
            nTx = 1 + nTx + 2; // ENQ code + number of send data + number of sum codes

            nRet = WriteFile(hCom,szTx,nTx,&nTx,NULL);
            // **** Send ****
            if(nRet != 0) {
                nRet = ReadFile(hCom,szRx,sizeof(szRx),&nRx,NULL);
                // **** Receive ****
                if(nRet != 0) {
                    // **** Display receive data ****
                    for(i = 0; i < nRx; i++) {
                        printf("%02X ",(BYTE)szRx[i]); // Output received data to console
                        // Display ASCII code in Hexadecimal! In case of 0, "30" is displayed.
                    }
                    printf("\n\r");
                }
            }
        }
        CloseHandle(hCom); // Close communication port
    }
}

```

General flowchart

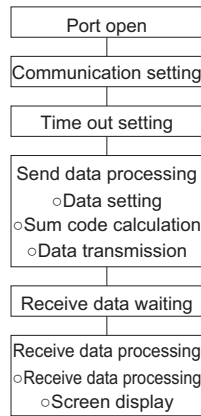

CAUTION

- Always set the communication check time interval before starting operation to prevent hazardous conditions.
- Data communication is not started automatically but is made only once when the computer provides a communication request. If communication is disabled during operation due to signal cable breakage etc., the inverter cannot be stopped. When the communication check time interval has elapsed, the inverter output will be shut off (E.PUE). Turn the RES signal of the inverter ON or shut off the power supply to coast the motor to a stop.
- If communication is broken due to signal cable breakage, computer fault etc., the inverter does not detect such a fault. This should be fully noted.

◆ Setting items and set data

- After completion of parameter settings, set the instruction codes and data, then start communication from the computer to allow various types of operation control and monitoring.

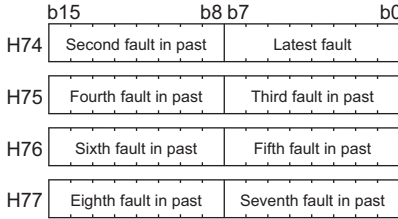
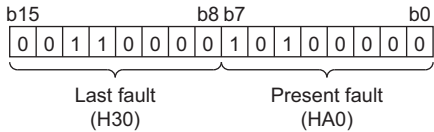
Item	Read/write	Instruction code	Data description	Number of data digits (format)*1					
Operation mode	Read	H7B	H0000: Network operation H0001: External operation, External operation (JOG operation) H0002: PU operation, External/PU combined operation, PUJOG operation	4 digits (B.E/D)					
	Write	HFB	H0000: Network operation H0001: External operation H0002: PU operation	4 digits (A,C/D)					
Monitor	Output frequency /	Read	H6F	H0000 to HFFFF: Output frequency in 0.01 Hz increments	4 digits (B.E/D)				
	Output current	Read	H70	H0000 to HFFFF: Output current (hexadecimal) Increments 0.01 A	4 digits (B.E/D)				
	Output voltage	Read	H71	H0000 to HFFFF: Output voltage (hexadecimal) in 0.1 V increments	4 digits (B.E/D)				
	Special monitor	Read	H72	H0000 to HFFFF: Monitor data selected in the instruction code HF3	4 digits (B.E/D)				
	Special monitor selection No.	Read	H73	Monitor selection data (Refer to page 124 for details on selection No.)	2 digits (B.E1/D)				
		Write	HF3		2 digits (A1, C/D)				
	Fault record	Read	H74 to H77	<p>H0000 to HFFFF: Two latest fault records</p>  <p>Fault record display example (instruction code H74)</p> <p>With the read data H30A0 (Last fault : THT) (Present fault : OPT)</p>  <p>(Refer to page 210 for details on fault record read data.)</p>	4 digits (B.E/D)				
					Operation command (extended)	Write	HF9	Control input commands such as the Forward rotation command (STF) signal and the Reverse rotation command (STR) signal can be set. (For the details, refer to page 181 .)	4 digits (A,C/D)
					Operation command	Write	HFA		2 digits (A1, C/D)
					Inverter status monitor (extended)	Read	H79	The states of the output signals such as the Forward rotation output, Reverse rotation output, and Inverter running (RUN) signals can be monitored. (For the details, refer to page 181 .)	4 digits (B.E/D)
Inverter status monitor					Read	H7A	2 digits (B.E1/D)		
Set frequency (RAM)	Read	H6D	Read the set frequency from the RAM or EEPROM. H0000 to HFFFF: Set frequency in 0.01 Hz increments	4 digits (B.E/D)					
Set frequency (EEPROM)		H6E							
Set frequency (RAM)	Write	HED	Write the set frequency into the RAM or EEPROM. H0000 to H9C40 (0 to 400.00 Hz): frequency in 0.01 Hz increments To change the set frequency consecutively, write data to the inverter RAM. (Instruction code: HED)	4 digits (A,C/D)					
Set frequency (RAM, EEPROM)		HEE							

Item	Read/write	Instruction code	Data description	Number of data digits (format) ^{*1}
Inverter reset	Write	HFD	H9696: Inverter reset As the inverter is reset at the start of communication by the computer, the inverter cannot send reply data back to the computer.	4 digits (A,C/D)
			H9966: Inverter reset When data is sent normally, ACK is returned to the computer, and then the inverter is reset.	4 digits (A, D)
Batch clearing of fault records	Write	HF4	H9696: Batch clearing of fault records	4 digits (A,C/D)
Parameter clear All parameter clear	Write	HFC	All parameters return to initial values. Whether to clear communication parameters or not can be selected according to the data. <ul style="list-style-type: none"> Parameter clear H9696: Communication parameters are cleared. H5A5A: Communication parameters are not cleared.^{*2} All parameter clear H9966: Communication parameters are cleared. H55AA: Communication parameters are not cleared.^{*2} For the details of whether or not to clear parameters, refer to page 386 . When a clear is performed with H9696 or H9966, communication related parameter settings also return to the initial values. When resuming the operation, set the parameters again. Performing a clear will clear the instruction code HEC, HF3, and HFF settings. Only H9966 and H55AA (all parameter clear) are valid during the password lock (refer to page 90).	4 digits (A,C/D)
Parameter	Read	H00 to H63	Refer to the instruction code list (on page 386) to read/write parameter settings as required. When setting Pr.100 and later, the link parameter extended setting must be set.	4 digits (B,E/D)
	Write	H80 to HE3		4 digits (A,C/D)
Link parameter extended setting	Read	H7F	Parameter settings are switched according to the H00 to H09 settings.	2 digits (B,E1/D)
	Write	HFF	For details of the settings, refer to the instruction code list (on page 386).	2 digits (A1, C/D)
Second parameter changing (instruction code HFF = 1, 9)	Read	H6C	When setting the calibration parameters ^{*3}	2 digits (B,E1/D)
	Write	HEC	H00: Frequency ^{*4} H01: Parameter-set analog value H02: Analog value input from terminal	2 digits (A1, C/D)

*1 Refer to [page 170](#) for the data format (A, A1, A2, B, C, C1, D, E, E1, E2, E3, or F).

*2 Turning OFF the power supply while clearing parameters with H5A5A or H55AA returns the communication parameter settings to the initial settings.

*3 Refer to the following list of calibration parameters for details.

*4 The gain frequency can be also written using **Pr.125** (instruction code: H99) or **Pr.126** (instruction code: H9A).

NOTE

- Set 65520 (HFFF0) as a parameter value "8888" and 65535 (HFFFF) as "9999".
- For the instruction codes HFF, HEC, and HF3, their values once written are held, but cleared to zero when an inverter reset or all clear is performed.

Example) When reading the **C3 (Pr.902)** and **C6 (Pr.904)** settings from the inverter of station No. 0.

	Computer send data	Inverter send data	Description
a	ENQ 00 FF 0 01 7D	ACK 00	"H01" is set in the extended link parameter.
b	ENQ 00 EC 0 01 79	ACK 00	"H01" is set in the second parameter changing.
c	ENQ 00 5E 0 0A	STX 00 0000 ETX 20	C3 (Pr.902) is read. "0%" is read.
d	ENQ 00 60 0 F6	STX 00 0000 ETX 20	C6 (Pr.904) is read. "0%" is read.

To read/write **C3 (Pr.902)** or **C6 (Pr.904)** after inverter reset or parameter clear, execute from (a) again.

◆ List of calibration parameters

Pr.	Name	Instruction code		
		Read	Write	Extended
C2 (902)	Terminal 2 frequency setting bias frequency	5E	DE	1
C3 (902)	Terminal 2 frequency setting bias	5E	DE	1
125 (903)	Terminal 2 frequency setting gain frequency	5F	DF	1
C4 (903)	Terminal 2 frequency setting gain	5F	DF	1
C5 (904)	Terminal 4 frequency setting bias frequency	60	E0	1
C6 (904)	Terminal 4 frequency setting bias	60	E0	1
126 (905)	Terminal 4 frequency setting gain frequency	61	E1	1
C7 (905)	Terminal 4 frequency setting gain	61	E1	1

◆ Operation command

Item	Instruction code	Bit length	Description ^{*1}	Example
Operation command	HFA	8 bits	b0: AU (Terminal 4 input selection) b1: Forward rotation command b2: Reverse rotation command b3: RL (Low-speed operation command) b4: RM (Middle-speed operation command) b5: RH (High-speed operation command) b6: Second function selection b7: Output stop	[Example 1] H02 Forward rotation b7 b0 0 0 0 0 0 0 1 0 [Example 2] H00 Stop b7 b0 0 0 0 0 0 0 0 0
Operation command (extended)	HF9	16 bits	b0: AU (Terminal 4 input selection) b1: Forward rotation command b2: Reverse rotation command b3: RL (Low-speed operation command) b4: RM (Middle-speed operation command) b5: RH (High-speed operation command) b6: Second function selection b7: Output stop b8 to b15: –	[Example 1] H0002 Forward rotation b15 b0 0 0 0 0 0 0 0 0 0 0 0 0 0 0 0 1 0 [Example 2] H0804 Low-speed reverse operation (When Pr. 182 RH terminal function selection is set to "0") b15 b0 0 0 0 0 1 0 0 0 0 0 0 0 0 0 0 1 0 0

*1 A function described in parentheses () is initially assigned to the terminal. The function changes depending on the setting of Pr.180 to Pr.182 (Input terminal function selection) (page 142).

*2 During RS-485 communication through the PU connector, only the Forward rotation command and Reverse rotation command signals can be used.

◆ Inverter status monitor

Item	Instruction code	Bit length	Description ^{*1}	Example
Inverter status monitor	H7A	8 bits	b0: NET Y0 to Y4 b1: NET Y0 to Y4 b2: NET Y0 to Y4 b3: NET Y0 to Y4 b4: NET Y0 to Y4 b5: – b6: FU (Output frequency detection) b7: ABC (Fault)	[Example 1] H02 During forward rotation b7 b0 0 0 0 0 0 0 1 0 [Example 2] H00 Stop at fault occurrence b7 b0 0 0 0 0 0 0 0 0
Inverter status monitor (extended)	H79	16 bits	b0: NET Y0 to Y4 b1: NET Y0 to Y4 b2: NET Y0 to Y4 b3: NET Y0 to Y4 b4: NET Y0 to Y4 b5: – b6: Output frequency detection b7: ABC (Fault) b8 to b14: – b15: Fault occurrence	[Example 1] H0002 During forward rotation b15 b0 0 0 0 0 0 0 0 0 0 0 0 0 0 0 0 1 0 [Example 2] H8080 Stop at fault occurrence b15 b0 1 0 0 0 0 0 0 0 0 1 0 0 0 0 0 0 0

*1 A function described in parentheses () is initially assigned to the terminal. The function changes depending on the setting of Pr.190 to Pr.195 (Output terminal function selection).

5.11.5 MODBUS RTU communication specification

Through communication using the MODBUS RTU communication protocol via the PU connector on the inverter, inverter operation and parameter setting are available.

Pr.	Name	Initial value	Setting range	Description	
117 N020	PU communication station number	0	0 to 31	Specify the inverter station number. Enter the inverter station numbers when two or more inverters are connected to one personal computer.	
118 N021	PU communication speed	192	48, 96, 192, 384, 576, 768, 1152	Select the communication speed. The setting value × 100 equals the communication speed. For example, enter 192 to set the communication speed of 19200 bps.	
119	PU communication stop bit length / data length	1	0	Stop bit length 1 bit	Data length 8 bits
			1	Stop bit length 2 bits	
			10	Stop bit length 1 bit	Data length 7 bits
			11	Stop bit length 2 bits	
120 N024	PU communication parity check	2	0	Without parity check	
			1	With parity check at odd numbers	
			2	With parity check at even numbers	
122 N026	PU communication check time interval	9999	0	PU connector communication is disabled.	
			0.1 to 999.8 s	Set the interval of the communication check (signal loss detection) time If a no-communication state persists for longer than the permissible time, the inverter output will be shut off.	
			9999	No communication check (signal loss detection)	
343 N080	Communication error count	0	—	Displays the communication error count during MODBUS RTU communication. Read-only.	
549 N000	Protocol selection	0	0	Mitsubishi inverter protocol (computer link)	
			1	MODBUS RTU protocol	

NOTE

- To use the MODBUS RTU protocol, set "1" in **Pr.549 Protocol selection**.
- If MODBUS RTU communication is performed from the master to the address 0 (station number 0), the data is broadcasted, and the inverter does not send any reply to the master.
- Some functions are disabled in broadcast communication. (Refer to [page 184.](#))

◆ Communication specifications

- The communication specifications are given below.

Item	Description	Related parameter	
Communication protocol	MODBUS RTU protocol	Pr.549	
Conforming standard	EIA-485 (RS-485)	—	
Number of connectable units	1: N (maximum 32 units), setting is 0 to 247 stations	Pr.117	
Communication speed	Selected among 300/600/1200/2400/4800/9600/19200/38400/57600/76800/115200 bps	Pr.118	
Control procedure	Asynchronous method	—	
Communication method	Half-duplex system	—	
Communication specifications	Character system	Binary (fixed at 8 bits)	—
	Start bit	1 bit	—
	Stop bit length	Select from the following three types: No parity check, stop bit length 2 bits	Pr.120
	Parity check	Odd parity check, stop bit length 1 bit Even parity check, stop bit length 1 bit	
	Error check	CRC code check	
Terminator	Not available	—	
Time delay setting	Not available	—	

◆ Outline

- The MODBUS communication protocol was developed by Modicon for programmable controllers.
- The MODBUS protocol uses exclusive message frames to perform serial communication between a master and slaves. These exclusive message frames are provided with a feature called "functions" that allows data to be read or written. These functions can be used to read or write parameters from the inverter, write input commands to the inverter or check the inverter's operating status, for example. This product classifies the data of each inverter into holding register area (register address 40001 to 49999). The master can communicate with inverters (slaves) by accessing pre-assigned holding register addresses.

NOTE

- There are two serial transmission modes, the ASCII (American Standard Code for Information Interchange) mode and the RTU (Remote Terminal Unit) mode. However, this product supports only the RTU mode, which transfers 1 byte data (8 bits) as it is. Also, only communication protocol is defined by the MODBUS protocol. Physical layers are not stipulated.

◆ Message format

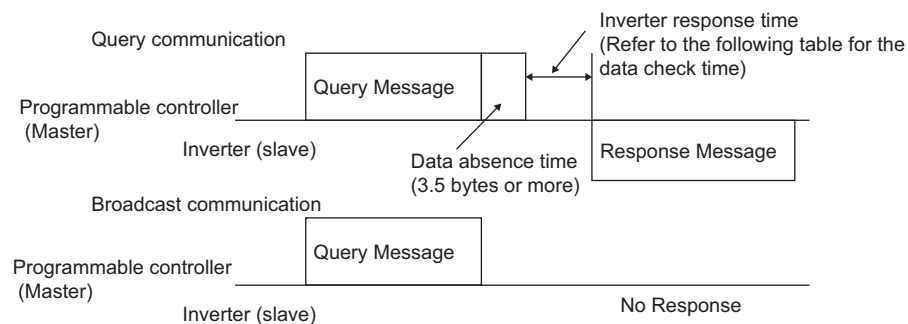

- Data check time

Item	Check time
Monitoring, operation command, frequency setting (RAM)	< 12 ms
Parameter read/write, frequency setting (EEPROM)	< 30 ms
Parameter clear / All parameter clear	< 5 s
Reset command	No reply

- Query
A message is sent to the slave (the inverter) having the address specified by the master.
- Normal response
After the query from the master is received, the slave executes the request function, and returns the corresponding normal response to the master.
- Error Response
When an invalid function code, address or data is received by the slave, the error response is returned to the master. This response is appended with an error code that indicates the reason why the request from the master could not be executed. This response cannot be returned for errors, detected by the hardware, frame error and CRC check error.
- Broadcast
The master can broadcast messages to all slaves by specifying address 0. All slaves that receive a message from the master execute the requested function. With this type of communication, slaves do not return a response to the master.

NOTE

- During broadcast communication, functions are executed regardless of the set inverter station number (Pr.117).

◆ Message frame (protocol)

- Communication method

Basically, the master sends a query message (inquiry), and slaves return a response message (response). At normal communication, the device address and function code are copied as they are, and at erroneous communication (illegal function code or data code), bit 7 (= H80) of the function code is turned ON, and the error code is set at data bytes.

Query message from Master

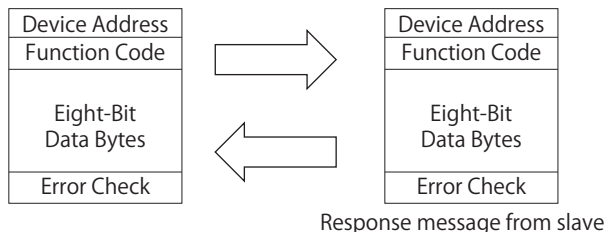

Message frames comprise the four message fields shown in the figures above.

A slave recognizes message data as one message when a 3.5 character long no-data time (T1: start/end) is added before and after the data.

- Details of protocol

The following table explains the four message fields.

Start Start	Address ADDRESS	Function FUNCTION	Data DATA	CRC check CRC CHECK		End End
T1	8 bits	8 bits	n × 8 bits	L 8 bits	H 8 bits	T1

Message field	Description
Address field	"0 to 247" can be set in the single-byte (8-bit) length field. Set "0" when sending broadcast messages (instructions to all addresses), and "1 to 247" to send messages to individual slaves. The response from the slave also contains the address set by the master. The value set in Pr.117 PU communication station number is the slave address.
Function field	"1 to 255" can be set as the function code in the single-byte (8-bit) length field. The master sets the function to be sent to the slave as the request, and the slave performs the requested operation. Refer to the function code list for details of the supported function codes. An error response is generated when a function code other than those in the function code list is set. The normal response from the slave contains the function code set by the master. The error response contains H80 and the function code.
Data field	The format changes according to the function code. (Refer to page 185 .) The data, for example, includes the byte count, number of bytes, and accessing content of holding registers.
CRC check field	Errors in the received message frame are detected. Errors are detected in the CRC check, and the 2 bytes length data is appended to the message. When the CRC is appended to the message, the lower bytes of the CRC are appended first, followed by the upper bytes. The CRC value is calculated by the sender that appends the CRC to the message. The receiver recalculates the CRC while the message is being received, and compares the calculation result against the actual value that was received in the error check field. If the two values do not match, the result is treated as an error.

◆ Function code list

Function name	Read/write	Code	Outline	Broadcast communication	Message format reference page
Read holding register	Read	H03	The data of the holding registers is read. The various data of the inverter can be read from MODBUS registers. System environmental variable (Refer to page 190.) Real time monitor (Refer to page 124.) Faults history (Refer to page 191.) Model information monitor (Refer to page 191.) Inverter parameters (Refer to page 191.)	Not available	page 185
Preset single register	Write	H06	Data is written to a holding register. Data can be written to MODBUS registers to output instructions to the inverter or set parameters. System environmental variable (Refer to page 190.) Inverter parameters (Refer to page 191.)	Available	page 186
Diagnostics	Read	H08	Functions are diagnosed. (Communication check only) A communication check can be made since the query message is sent and the query message is returned as it is as the return message (subfunction code H00 function). Subfunction code H00 (Return query data)	Not available	page 186
Preset multiple registers	Write	H10	Data is written to multiple consecutive holding registers. Data can be written to consecutive multiple MODBUS registers to output instructions to the inverter or set parameters. System environmental variable (Refer to page 190.) Inverter parameters (Refer to page 191.)	Available	page 187
Read holding register access log	Read	H46	The number of registers that were successfully accessed by the previous communication is read. Queries by function codes H03 and H10 are supported. The number and start address of holding registers successfully accessed by the previous communication are returned. "0" is returned for both the number and start address for queries other than function code H03 and H10.	Not available	page 188

◆ Read Holding Register (reading data of holding registers) (H03 or 03)

- Query message

a. Slave address	b. Function	c. Starting address		d. No. of points		CRC check	
(8 bits)	H03 (8 bits)	H (8 bits)	L (8 bits)	H (8 bits)	L (8 bits)	L (8 bits)	H (8 bits)

- Normal response (Response message)

a. Slave address	b. Function	e. Byte count	f. Data			CRC check	
(8 bits)	H03 (8 bits)	(8 bits)	H (8 bits)	L (8 bits)	... (n × 16 bits)	L (8 bits)	H (8 bits)

- Query message setting

Message		Description
a	Slave address	Set the address to send messages to. Broadcast communication is not possible. (Invalid when "0" is set.)
b	Function	Set H03.
c	Starting address	Set the holding register address from which to start reading the data. Starting address = start register address (decimal) - 40001 For example, when starting register address 0001 is set, the data of holding register address 40002 is read.
d	No. of points	Set the number of holding registers for reading data. Data can be read from up to 125 registers.

- Content of normal response

Message		Description
e	Byte count	The setting range is H02 to HFA (2 to 250). Twice the number of reads specified by (d) is set.
f	Data	The amount of data specified by (d) is set. Read data is output Hi bytes first followed by Lo bytes, and is arranged as follows: data of start address, data of start address+1, data of start address+2, and so forth.

■ **Example) Read the register values of 41004 (Pr.4) to 41006 (Pr.6) from slave address 17 (H11).**

Query message

Slave address	Function	Starting address		No. of points		CRC check	
H11 (8 bits)	H03 (8 bits)	H03 (8 bits)	HEB (8 bits)	H00 (8 bits)	H03 (8 bits)	H77 (8 bits)	H2B (8 bits)

Normal response (Response message)

Slave address	Function	Byte count	Data						CRC check	
H11 (8 bits)	H03 (8 bits)	H06 (8 bits)	H17 (8 bits)	H70 (8 bits)	H0B (8 bits)	HB8 (8 bits)	H03 (8 bits)	HE8 (8 bits)	H2C (8 bits)	HE6 (8 bits)

Read value

Register 41004 (Pr.4): H1770 (60.00 Hz)

Register 41005 (Pr.5): H0BB8 (30.00 Hz)

Register 41006 (Pr.6): H03E8 (10.00 Hz)

◆ **Preset Single Register (writing data to holding registers) (H06 or 06)**

- The content of the system environmental variables and inverter parameters (refer to [page 189](#)) assigned to the holding register area can be written.
- Query message

a. Slave address	b. Function	c. Register address		d. Preset data		CRC check	
(8 bits)	H06 (8 bits)	H (8 bits)	L (8 bits)	H (8 bits)	L (8 bits)	L (8 bits)	H (8 bits)

- Normal response (Response message)

a. Slave address	b. Function	c. Register address		d. Preset data		CRC check	
(8 bits)	H06 (8 bits)	H (8 bits)	L (8 bits)	H (8 bits)	L (8 bits)	L (8 bits)	H (8 bits)

- Query message setting

Message		Description
a	Slave address	Set the address to send messages to. Setting "0" enables broadcast communication.
b	Function	Set H06.
c	Register address	Set the holding register address to write data to. Register address = holding register address (decimal) - 40001 For example, when register address 0001 is set, data is written to holding register address 40002.
d	Preset Data	Set the data to write to the holding register. Write data is fixed at 2 bytes.

- Content of normal response

With a normal response, the contents in the response (a to d, including the CRC check) are the same as those in the query messages.

In the case of broadcast communication, no response is returned.

■ **Example) Write 60 Hz (H1770) to 40014 (running frequency RAM) of slave address 5 (H05).**

Query message

Slave address	Function	Register address		Preset data		CRC check	
H05 (8 bits)	H06 (8 bits)	H00 (8 bits)	H0D (8 bits)	H17 (8 bits)	H70 (8 bits)	H17 (8 bits)	H99 (8 bits)

Normal response (Response message)

The same data as those in the query message

NOTE

- With broadcast communication, no response is generated even if a query is executed, so when the next query is made, it must be made after waiting for the inverter data processing time after the previous query is executed.

◆ **Diagnostics (diagnosis of functions) (H08 or 08)**

- A communication check can be made since the query message is sent and the query message is returned as it is as the return message (subfunction code H00 function). Subfunction code H00 (Return query data)

- Query message

a. Slave address	b. Function	c. Subfunction		d. Data		CRC check	
(8 bits)	H08 (8 bits)	H00 (8 bits)	H00 (8 bits)	H (8 bits)	L (8 bits)	L (8 bits)	H (8 bits)

- Normal response (Response message)

a. Slave address	b. Function	c. Subfunction		d. Data		CRC check	
(8 bits)	H08 (8 bits)	H00 (8 bits)	H00 (8 bits)	H (8 bits)	L (8 bits)	L (8 bits)	H (8 bits)

- Query message setting

Message		Description
a	Slave address	Set the address to send messages to. Broadcast communication is not possible. (Invalid when "0" is set.)
b	Function	Set H08.
c	Subfunction	Set H0000.
d	Data	Any 2-byte long data can be set. The setting range is H0000 to HFFFF.

- Content of normal response

With a normal response, the contents in the response (a to d, including the CRC check) are the same as those in the query messages.

NOTE

- With broadcast communication, no response is generated even if a query is executed, so when the next query is made, it must be made after waiting for the inverter data processing time after the previous query is executed.

◆ Preset Multiple Registers (writing data to multiple holding registers) (H10 or 16)

- Data can be written to multiple holding registers.
- Query message

a. Slave address	b. Function	c. Starting address		d. No. of registers		e. Byte count	f. Data			CRC check	
(8 bits)	H10 (8 bits)	H (8 bits)	L (8 bits)	H (8 bits)	L (8 bits)	(8 bits)	H (8 bits)	L (8 bits)	... (n × 2 × 8 bits)	L (8 bits)	H (8 bits)

- Normal response (Response message)

a. Slave address	b. Function	c. Starting address		d. No. of registers		CRC check	
(8 bits)	H10 (8 bits)	H (8 bits)	L (8 bits)	H (8 bits)	L (8 bits)	L (8 bits)	H (8 bits)

- Query message setting

Message		Description
a	Slave address	Set the address to send messages to. Setting "0" enables broadcast communication.
b	Function	Set H10.
c	Starting address	Set the holding register address from which to start writing the data. Starting address = start register address (decimal) - 40001 For example, when starting register address 0001 is set, the data of holding register address 40002 is read.
d	No. of registers	Set the number of holding registers for writing data. Data can be written to up to 125 registers.
e	Byte count	The setting range is H02 to HFA (2 to 250). Set twice the value specified by d.
f	Data	Set the amount of data specified by d. Write data is output Hi bytes first followed by Lo bytes, and is arranged as follows: data of start address, data of start address+1, data of start address+2, and so forth.

- Content of normal response

With a normal response, the contents in the response (a to d, including the CRC check) are the same as those in the query messages.

Query message

Slave address	Function	Starting address		No. of registers		Byte count	Data				CRC check	
H19 (8 bits)	H10 (8 bits)	H03 (8 bits)	HEE (8 bits)	H00 (8 bits)	H02 (8 bits)	H04 (8 bits)	H00 (8 bits)	H05 (8 bits)	H00 (8 bits)	H0A (8 bits)	H86 (8 bits)	H3D (8 bits)

Normal response (Response message)

Slave address	Function	Starting address		No. of registers		CRC check	
H19 (8 bits)	H10 (8 bits)	H03 (8 bits)	HEE (8 bits)	H00 (8 bits)	H02 (8 bits)	H22 (8 bits)	H61 (8 bits)

◆ Read holding register access log (H46 or 70)

- Queries by function codes H03 and H10 are supported. The number and start address of holding registers successfully accessed by the previous communication are returned. "0" is returned for both the number and start address for queries other than the function codes above.
- Query message

a. Slave address	b. Function	CRC check	
(8 bits)	H46 (8 bits)	L (8 bits)	H (8 bits)

- Normal response (Response message)

a. Slave address	b. Function	c. Starting address		d. No. of points		CRC check	
(8 bits)	H46 (8 bits)	H (8 bits)	L (8 bits)	H (8 bits)	L (8 bits)	L (8 bits)	H (8 bits)

- Query message setting

Message		Description
a	Slave address	Set the address to send messages to. Broadcast communication is not possible. (Invalid when "0" is set.)
b	Function	Set H46.

- Content of normal response

Message		Description
c	Starting address	The start address of the holding register that was successfully accessed is returned. Starting address = start register address (decimal) - 40001 For example, when starting address 0001 is returned, the holding register address that was successfully accessed is 40002.
d	No. of points	The number of holding registers that were successfully accessed is returned.

■ Example) Read the successful register start address and number of successful accesses from slave address 25 (H19).

Query message

Slave address	Function	CRC check	
H19 (8 bits)	H46 (8 bits)	H8B (8 bits)	HD2 (8 bits)

Normal response (Response message)

Slave address	Function	Starting address		No. of points		CRC check	
H19 (8 bits)	H10 (8 bits)	H03 (8 bits)	HEE (8 bits)	H00 (8 bits)	H02 (8 bits)	H22 (8 bits)	H61 (8 bits)

The number of holding registers that were successfully accessed was returned as two with the start address 41007 (Pr.7).

◆ Error response

- An error response is returned if the query message received from the master contains an illegal function, address or data. No response is returned for parity, CRC, overrun, framing, and busy errors.

NOTE

- No response is also returned in the case of broadcast communication.

- Error response (Response message)

a. Slave address	b. Function	c. Exception code	CRC check	
(8 bits)	H80 + Function (8 bits)	(8 bits)	L (8 bits)	H (8 bits)

	Message	Description
a	Slave address	Set the address received from the master.
b	Function	The function code requested by the master and H80 is set.
c	Exception code	The codes in the following table are set.

- Error code list

Code	Error item	Error description
01	ILLEGAL FUNCTION	The query message from the master has a function code that cannot be handled by the slave.
02	ILLEGAL DATA ADDRESS *1	The query message from the master has a register address that cannot be handled by the slave. (No parameter, parameter cannot be read, parameter cannot be written)
03	ILLEGAL DATA VALUE	The query message from the master has data that cannot be handled by the slave. (Out of parameter write range, a mode is specified, or other error)

*1 An error response is not returned in the following cases:

- (a) Function code H03 (reading data of holding registers)

When the number of registers is specified as one or more and there are one or more holding registers from which data can be read

- (b) Function code H10 (writing data to multiple holding registers)

When the number of registers is specified as one or more and there are one or more holding registers to which data can be written.

In other words, when function code H03 or H10 is used and multiple holding registers are accessed, an error response is not returned even if a nonexistent holding register or holding register that cannot be read or written from/to is accessed.

NOTE

- An error response is returned if none of the accessed holding registers exist. When an accessed holding register does not exist, the read value is 0 and the written data is invalid.

- Error detection of message data

The following errors are detected in message data from the master. The inverter output is not shut off even if an error is detected.

Error check items

Error item	Error description	Inverter operation
Parity error	The data received by the inverter is different from the specified parity (Pr.120 setting).	When this error occurs, Pr.343 is incremented by one. When this error occurs, the LF signal is output.
Framing error	The data received by the inverter is different from the stop bit length (Pr.120) setting.	
Overrun error	The next data has been sent by the master before the inverter completes receiving the preceding data.	
Message frame error	The data length of the message frame is checked, and an error is generated if the received data length is less than 4 bytes.	
CRC check error	An error is generated if the data in the message frame does not match the calculation result.	

NOTE

- The LF signal can be assigned to an output terminal by setting any of **Pr.190 to Pr.195 (Output terminal function selection)**. Changing the terminal assignment may affect other functions. Set parameters after confirming the function of each terminal.

◆ MODBUS register

- The following shows the MODBUS registers for system environment variables (read/write), real time monitor items (read), parameters (read/write), faults history data (read/write), and model information monitor items (read).

- System environment variable

Register	Definition	Read/write	Remarks
40002	Inverter reset	Write	Any value
40003	Parameter clear	Write	Set H965A.
40004	All parameter clear	Write	Set H99AA.
40006	Parameter clear ^{*1}	Write	Set H5A96.
40007	All parameter clear ^{*1}	Write	Set HAA99.
40009	Inverter status / control input command ^{*2}	Read/Write	—
40010	Operation mode / inverter setting ^{*3}	Read/Write	—
40014	Running frequency (RAM value)	Read/write	—
40015	Running frequency (EEPROM value)	Write	—

*1 Settings in the communication parameters are not cleared.

*2 The data is written as a control input command for writing.
The data is read as the inverter status for reading.

*3 The data is written as an operation mode setting for writing.
The data is read as the operation mode status for reading.

- Inverter status / control input command

Bit	Definition	
	Control input command	Inverter status
0	Stop command	RUN (Inverter running) ^{*5}
1	Forward rotation command	Forward running
2	Reverse rotation command	Reverse running
3	RH (High-speed operation command) ^{*4}	SU (Up to frequency) ^{*5}
4	RM (Middle-speed operation command) ^{*4}	OL (Overload warning) ^{*5}
5	RL (Low-speed operation command) ^{*4}	No function
6	0	FU (Output frequency detection) ^{*5}
7	RT (Second function selection) ^{*4}	ABC (Fault) ^{*5}
8	AU (Terminal 4 input selection) ^{*4}	0
9	0	0
10	MRS (Output stop) ^{*4}	0
11	0	0
12	0	0
13	0	0
14	0	0
15	0	Fault occurrence

*4 A function described in parentheses () is initially assigned to the signal. The function changes depending on the setting of **Pr.180 to Pr.182 (Input terminal function selection)** (page 142).

The signals assigned to the input terminals may be valid or invalid in the NET operation mode. (Refer to page 107.)

*5 A function described in parentheses () is initially assigned to the signal. The function changes depending on the setting of **Pr.195 (Output terminal function selection)** (page 126).

- Operation mode / inverter setting

Mode	Read value	Write value
EXT	H0000	H0010 ^{*6}
PU	H0001	H0011 ^{*6}
EXT JOG	H0002	—
PU JOG	H0003	—
NET	H0004	H0014
PU + EXT	H0005	—

*6 Writing is available depending on the **Pr.79** and **Pr.340** settings. For the details, refer to page 104.
Restrictions in each operation mode conform with the computer link specification.

- Real time monitor

Refer to page 124 for the register numbers and monitor items of the real time monitor.

- Parameters

Pr.	Register	Name	Read/write	Remarks
0 to 999	41000 to 41999	Refer to the parameter list (page page 72) for parameter names.	Read/Write	The parameter number + +41000 is the register number.
C2 (902)	41902	Terminal 2 frequency setting bias (frequency)	Read/write	
C3 (902)	42092	Terminal 2 frequency setting bias (analog value)	Read/write	Analog value (%) set in C3 (902)
	43902	Terminal 2 frequency setting bias (terminal analog value)	Read	Analog value (%) of the voltage (current) applied to terminal 2
125 (903)	41903	Terminal 2 frequency setting gain (frequency)	Read/write	
C4 (903)	42093	Terminal 2 frequency setting gain (analog value)	Read/write	Analog value (%) set in C4 (903)
	43903	Terminal 2 frequency setting gain (terminal analog value)	Read	Analog value (%) of the voltage (current) applied to terminal 2
C5 (904)	41904	Terminal 4 frequency setting bias (frequency)	Read/write	
C6 (904)	42094	Terminal 4 frequency setting bias (analog value)	Read/write	Analog value (%) set in C6 (904)
	43904	Terminal 4 frequency setting bias (terminal analog value)	Read	Analog value (%) of the current (voltage) applied to terminal 4
126 (905)	41905	Terminal 4 frequency setting gain (frequency)	Read/write	
C7 (905)	42095	Terminal 4 frequency setting gain (analog value)	Read/write	Analog value (%) set in C7 (905)
	43905	Terminal 4 frequency setting gain (terminal analog value)	Read	Analog value (%) of the current (voltage) applied to terminal 4

- Fault history

Register	Definition	Read/write	Remarks
40501	Fault record 1	Read/Write	Being 2 bytes in length, the data is stored as H00○○. Refer to the lowest 1 byte for the error code. (For details on error codes, refer to page 210 .) Performing write using the register 40501 batch-clears the faults history. Set any value as data.
40502	Fault record 2	Read	
40503	Fault record 3	Read	
40504	Fault record 4	Read	
40505	Fault record 5	Read	
40506	Fault record 6	Read	
40507	Fault record 7	Read	
40508	Fault record 8	Read	

- Product profile

Register	Definition	Read/write	Remarks
44001	Model (1st and 2nd characters)	Read	The inverter model can be read in ASCII code. "H20" (blank code) is set for blank area. Example) FR-CS84: H46,H52,H2D,H43,H53,H38,H34
44002	Model (3rd and 4th characters)	Read	
44003	Model (5th and 6th characters)	Read	
44004	Model (7th and 8th characters)	Read	
44005	Model (9th and 10th characters)	Read	
44006	Model (11th and 12th characters)	Read	
44007	Model (13th and 14th characters)	Read	
44008	Model (15th and 16th characters)	Read	
44009	Model (17th and 18th characters)	Read	
44010	Model (19th and 20th characters)	Read	
44011	Capacity (1st and 2nd characters)	Read	The capacity in the inverter model can be read in ASCII code. Data is read in increments of 0.1 kW, and rounds down to 0.01 kW increments. "H20" (blank code) is set for blank area. Example) 0.75K: " 7" (H20, H20, H20, H20, H20, H37)
44012	Capacity (3rd and 4th characters)	Read	
44013	Capacity (5th and 6th characters)	Read	

NOTE

- When a 32-bit parameter setting or monitor item is read and the value to be read exceeds HFFFF, HFFFF is returned.

◆ Pr.343 Communication error count

- The communication error occurrence count can be checked.

Parameter	Setting range	Minimum setting range	Initial value
343	(Read-only)	1	0

NOTE

- The communication error count is temporarily stored in the RAM memory. The value is not stored in EEPROM, and so is cleared to 0 when power is reset and the inverter is reset.

◆ Alarm (LF) signal output (communication error warning)

- During a communication error, the Alarm (LF) signal is output by open collector output. Use Pr.195 (Output terminal function selection) to assign the function.

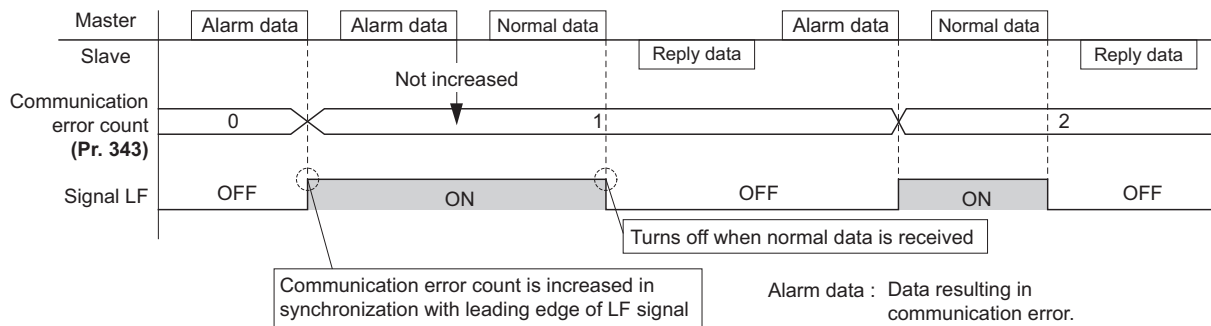

NOTE

- The LF signal can be assigned to an output terminal by setting Pr.195. Changing the terminal assignment may affect other functions. Set parameters after confirming the function of each terminal.

5.12 (G) Control parameters

Purpose	Parameter to set			Refer to page
To set the starting torque manually	Manual torque boost	P.G000	Pr.0	193
To set the motor constant	Base frequency, base frequency voltage	P.G001, P.G002	Pr.3, Pr.19	194
To perform energy saving operation	Energy saving operation	P.G030	Pr.60	195
To use a special motor	Adjustable 3 points V/F	P.C100, P.G040 to P.G045	Pr.71, Pr.100 to Pr.105	195
To adjust the motor braking torque	DC injection brake	P.G100 to P.G103	Pr.10 to Pr.12	197
To coast the motor to a stop	Selection of motor stop method	P.G106	Pr.250	198
To avoid overvoltage fault due to regenerative driving by automatic adjustment of output frequency	Regeneration avoidance function	P.G120, P.G121, P.G123, P.G124, P.G125	Pr.882, Pr.883, Pr.885, Pr.886, Pr.665	199
To decrease the deceleration time of the motor	Increased magnetic excitation deceleration	P.G130 to P.G132	Pr.660 to Pr.662	200
To secure the low-speed torque by compensating the slip of the motor	Slip compensation	P.G203 to P.G205	Pr.245 to Pr.247	202

5.12.1 Manual torque boost



Voltage drop in the low-frequency range can be compensated, improving reduction of the motor torque in the low-speed range.

- Motor torque in the low-frequency range can be adjusted according to the load, increasing the motor torque at the start up.

Pr.	Name	Initial value	Setting range	Description
0 G000	Torque boost	6% ^{*1}	0 to 30%	Set the output voltage at 0 Hz in %.
		4% ^{*2}		
		3% ^{*3}		
		2% ^{*4}		

*1 The Initial value for the FR-CS84-022 or lower and FR-CS82S-042 or lower.

*2 The Initial value for the FR-CS84-036 to FR-CS84-080, FR-CS82S-070, FR-CS82S-100.

*3 The Initial value for the FR-CS84-120 and the FR-CS84-160.

*4 The Initial value for the FR-CS84-230 and the FR-CS84-295.

◆ Starting torque adjustment

- Assuming Pr.19 Base frequency voltage is 100%, set the output voltage at 0 Hz to Pr.0 in percentage.
- Perform the adjustment of the parameter little by little (approximately 0.5%), and confirm the status of the motor each time. The motor may overheat when the value is set too high. Do not use more than 10% as a guideline.

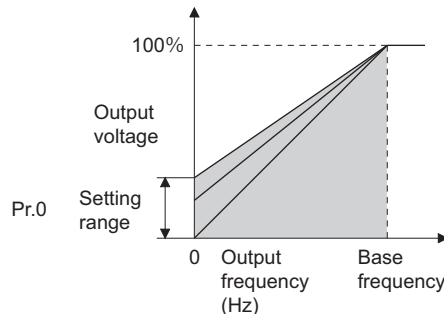

NOTE

- Set a larger value when the distance between the inverter and the motor is long or when there is not enough motor torque in the low-speed range. It may cause overcurrent trip when it is set too large.
- Setting for **Pr.0** is enabled only when the V/F control is selected.
- When the SF-PR motor is used, the output current tends to increase compared with the case where the SF-JR or SF-HR motor is used. When the protective function such as the electronic thermal O/L relay (E.THT, E.THM) or stall prevention (OLC, E.OLT) is activated, adjust the **Pr.0** according to the load.

«Parameters referred to»

Pr.3 Base frequency, Pr.19 Base frequency voltage [page 194](#)
 Pr.71 Applied motor [page 147](#)

5.12.2 Base frequency voltage



Use this function to adjust the inverter outputs (voltage, frequency) to match with the motor rating.

Pr.	Name	Initial value	Setting range	Description
3 G001	Base frequency	50 Hz	10 to 400 Hz	Set the frequency at the rated motor torque. (50/60 Hz)
19 G002	Base frequency voltage	8888	0 to 1000 V	Set the base voltage.
			8888	95% of the power supply voltage.
			9999	Same as the power supply voltage.

◆ Setting of base frequency (Pr.3)

- When operating a standard motor, generally set the rated frequency of the motor in **Pr.3 Base frequency**. When the motor operation require switching to the commercial power supply, set the power supply frequency in **Pr.3**.
- When the frequency described on the motor rating plate is "50 Hz" only, make sure to set to 50 Hz. When it is set to 60 Hz, the voltage will drop too much, causing insufficient torque. As a result, the inverter output may be shut off due to overload.
- When using the Mitsubishi Electric constant torque motor, set **Pr.3** to 60 Hz.

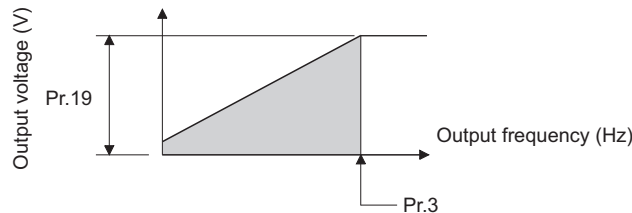

NOTE

- Set "3" in any of **Pr.178 to Pr.182 (Input terminal function selection)** to assign the RT signal to another terminal.

◆ Setting of base frequency voltage (Pr.19)

- Use **Pr.19 Base frequency voltage** to set the base voltage (for example, rated motor voltage).
- When a value equal to or lower than the power supply voltage is set, maximum output voltage of the inverter is the voltage set in **Pr.19**.
- **Pr.19** can be used in the following cases:
 - (a) When regenerative driving (continuous regeneration, etc.) is performed frequently
 Output voltage will get higher than the specification during the regenerative driving, which may cause overcurrent trip (E.OC[]) by the increase in motor current.
 - (b) When the fluctuation of power supply voltage is high
 When the power supply voltage exceeds the rated voltage of the motor, fluctuation of rotation speed or overheating of motor may occur due to excessive torque or increase in motor current.

NOTE

- When "2" (adjustable 3 points V/F) is set in Pr.71 Applied motor, "8888" or "9999" cannot be set in **Pr.19**.

Parameters referred to

Pr.29 Acceleration/deceleration pattern selection [page 95](#)
 Pr.71 Applied motor [page 147](#)

5.12.3 Energy saving control

The inverter will automatically perform energy saving operation without setting detailed parameters. This control method is suitable for applications such as fans and pumps.

Pr.	Name	Initial value	Setting range	Description
60 G030	Energy saving control selection	0	0	Normal operation.
			9	Optimum excitation control.

◆ Optimum excitation control (Pr.60 = "9").

- Set "9" in Pr.60 to select the Optimum excitation control mode.
- The Optimum excitation control is a control method to decide the output voltage by controlling the excitation current so the efficiency of the motor is maximized.

NOTE

- In the Optimum excitation control mode, an energy saving effect cannot be expected when the motor capacity is extremely small compared with the inverter capacity or when multiple motors are connected to a single inverter.
- When the Optimum excitation control mode is selected, the deceleration time may become longer than the setting value. Also, it may cause overvoltage more often compared to constant-torque load characteristics, so set the deceleration time longer.
- When the motor is unstable during acceleration, set the acceleration time longer.

5.12.4 Adjustable 3 points V/F



By setting a desired V/F characteristic from the start up to the base frequency or base voltage with the V/F control (frequency voltage/frequency), a dedicated V/F pattern can be generated.

The optimal V/F pattern matching the torque characteristics of the facility can be set.

Pr.	Name	Initial value	Setting range	Description
71 C100	Applied motor	0	2	Standard motor (such as SF-JR) Adjustable 3 points V/F.
			Others	Refer to page 147 .
100 G040	V/F1 (first frequency)	9999	0 to 400 Hz, 9999	Set each point of the V/F pattern (frequency, voltage). 9999: Do not set V/F.
101 G041	V/F1 (first frequency voltage)	0 V	0 to 1000 V	
102 G042	V/F2 (second frequency)	9999	0 to 400 Hz, 9999	
103 G043	V/F2 (second frequency voltage)	0 V	0 to 1000 V	
104 G044	V/F3 (third frequency)	9999	0 to 400 Hz, 9999	
105 G045	V/F3 (third frequency voltage)	0 V	0 to 1000 V	

- By setting the V/F1 (first frequency voltage / first frequency) to V/F3 parameters in advance, a desired V/F characteristic can be obtained.
- For an example, with the equipment with large static friction factor and small dynamic friction factor, large torque is required only at the start up, so a V/F pattern that will raise the voltage only at the low-speed range is set.
- Setting procedure

1. Set the rated motor voltage in **Pr.19 Base frequency voltage**.
(No function at the setting of "9999" or "8888".)
2. Set **Pr.71 Applied motor** = "2" (adjustable 3 points V/F).
3. Set frequency and voltage to be set in **Pr.100 to Pr.105**.

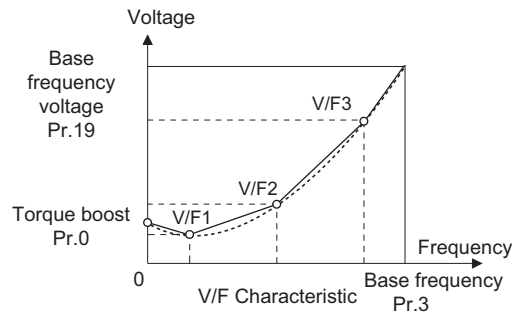

⚠ CAUTION

- Make sure to set the parameters correctly according to the motor used. Incorrect setting may cause the motor to overheat and burn.

📌 NOTE

- The adjustable 3 points V/F is enabled under V/F control.
- When **Pr.19 Base frequency voltage** = "8888 or 9999", setting of **Pr.71** = "2" is not available. To set "2" in **Pr.71**, set the rated motor voltage in **Pr.19**.
- A write disable error "Er 1" is displayed when the same frequency value is used for multiple points.
- Set frequency or voltage for each point in **Pr.100 to Pr.105** within the range of **Pr.3 Base frequency** or **Pr.19 Base frequency voltage**.
- When **Pr.71** = "2", the inverter calculates the characteristic of the electronic thermal O/L relay for a standard motor.
- By simultaneously using **Pr.60 Energy saving control selection** and the adjustable 3 points V/F, further energy saving effect is expected.

« Parameters referred to »

Pr.0 Torque boost [page 193](#)

Pr.3 Base frequency, Pr.19 Base frequency voltage [page 194](#)

Pr.12 DC injection brake operation voltage [page 197](#)

Pr.60 Energy saving control selection [page 195](#)

Pr.71 Applied motor [page 147](#)

5.12.5 DC injection brake

- Adjust the braking torque and timing to stop the motor using the DC injection brake.

By the DC injection brake operation, DC voltage is applied to the motor to prevent rotation of the motor shaft. When a motor shaft is rotated by external force, the motor shaft does not go back to the original position.

Pr.	Name	Initial value	Setting range	Description
10 G100	DC injection brake operation frequency	3 Hz	0 to 120 Hz	Set the operation frequency for the DC injection brake.
11 G101	DC injection brake operation time	0.5 s	0	Without DC injection brake.
			0.1 to 10 s	Set the operation time for the DC injection brake.
12 G110	DC injection brake operation voltage	4%	0 to 30%	Set the DC injection brake voltage (torque). When set to "0", the DC injection brake is not applied.

◆ Setting of operating frequency (Pr.10)

- Set the operation frequency for the DC injection brake in Pr.10 DC injection brake operation frequency to operate the DC injection brake when the output frequency decelerates to the set frequency.
- The DC injection brake operation frequency depends on the stopping method.

Stopping method	Parameter setting	DC injection brake operation frequency
Press the STOP key on the PU. Turn OFF the STF/STR signal.	0.5 Hz or higher in Pr.10 .	Pr.10 setting.
	Lower than 0.5 Hz in Pr.10 , and 0.5 Hz or higher in Pr.13 .	0.5 Hz.
	Lower than 0.5 Hz in both Pr.10 and Pr.13 .	Pr.10 or Pr.13 setting, whichever is higher.
Set frequency to 0 Hz	—	Pr.13 setting or 0.5 Hz, whichever is lower.

◆ Operation time setting (Pr.11)

- Set the operation time for the DC injection brake to **Pr.11 DC injection brake operation time**.
- When the motor does not stop due to large load moment (J), increase the setting to ensure the effect.
- The DC injection brake operation is not available when "0" is set in **Pr.11**. (The motor will coast to stop.)

◆ Setting of operation voltage (torque) (Pr.12)

- Set the percentage against the power supply voltage in **Pr.12 DC injection brake operation voltage**.
- The DC injection brake operation is not available when "0" is set in **Pr.12**. (The motor will coast to stop.)

NOTE

- Even if a larger value is set in **Pr.12**, braking torque is limited so the output current will be within the rated current of the inverter.

⚠ CAUTION

- Install a mechanical brake to make an emergency stop or to stay stopped for a long time.

Parameters referred to

Pr.13 Starting frequency  page 99

Pr.71 Applied motor  page 147

Pr.80 Motor capacity  page 147

5.12.6 Stop selection

Select the stopping method (deceleration stop or coasting) at turn-OFF of the start signal.

Coasting can be selected for the cases such that the motor is stopped with a mechanical brake at turn-OFF of the start signal.

The operation of the start signal (STF/STR) can be selected. (For the start signal selection, refer to [page 145](#).)

Pr.	Name	Initial value	Setting range	Description	
				Start signal (STF/STR) ^{*1}	Stop operation
250 G106	Stop selection	9999	0 to 100 s	STF signal: Forward rotation start STR signal: Reverse rotation start	The motor coasts to a stop after a lapse of the setting time when the start signal is turned OFF.
			1000 to 1100 s	STF signal: Start signal STR signal: Forward/reverse rotation signal	The motor coasts to a stop after a lapse of the (Pr.250 - 1000) seconds when the start signal is turned OFF.
			9999	STF signal: Forward rotation start STR signal: Reverse rotation start	The motor is decelerated to a stop when the start signal is turned OFF.

*1 For the start signal selection, refer to [page 145](#).

◆ To decelerate the motor to a stop

- Set Pr.250 = "9999 (initial value)".
- The motor is decelerated to a stop when the start signal (STF/STR) is turned OFF.

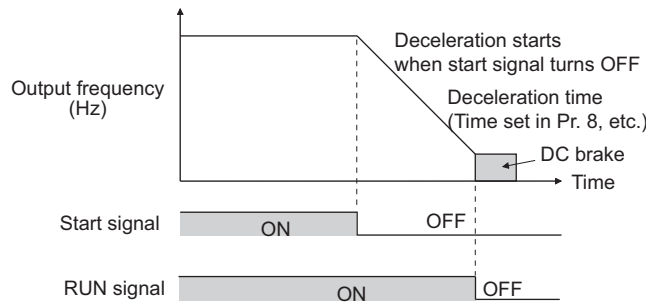

◆ To coast the motor to a stop

- Set the time required to shut off the output after the start signal is turned OFF in Pr.250. When "1000 to 1100" is set, output is shut off after a lapse of (Pr.250 - 1000) seconds.
- The output is shut off after a lapse of the setting time of Pr.250 when the start signal is turned OFF. Motor coasts to a stop.
- The RUN signal is turned OFF when the output is stopped.

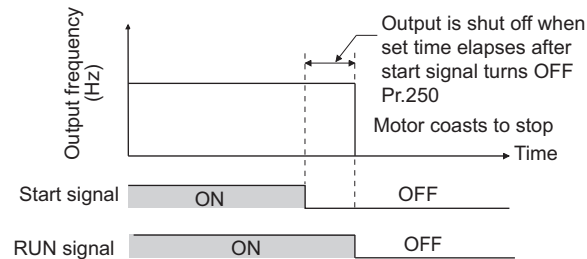

NOTE

- The stop selection setting is disabled when the following functions are operating.
 - Power failure stop function (Pr.261)
 - PU stop (Pr.75)
 - Deceleration stop due to a communication error (Pr.502)
- When Pr.250 ≠ "9999", acceleration/deceleration is performed in accordance to the frequency command until the output is shut off by turning OFF the start signal.
- When the restart signal is turned ON during the motor coasting, the operation is resumed from Pr.13 Starting frequency.

Parameters referred to

Pr.7 Acceleration time, Pr.8 Deceleration time [page 93](#)
 Pr.13 Starting frequency [page 99](#)
 Pr.75 Reset selection/disconnected PU detection/PU stop selection [page 85](#)
 Pr.261 Power failure stop selection [page 160](#)
 Pr.502 Stop mode selection at communication error [page 165](#)

5.12.7 Regeneration avoidance function

The regenerative status can be detected and avoided by raising the frequency.

- The operation frequency is automatically increased to prevent the regenerative operations. This function is useful when a load is forcibly rotated by another fan in the duct.

Pr.	Name	Initial value		Setting range	Description
882 G120	Regeneration avoidance operation selection	0		0	The regeneration avoidance function is disabled.
				1	The regeneration avoidance function is always enabled.
				2	The regeneration avoidance function is enabled only during constant-speed operation.
883 G121	Regeneration avoidance operation level	200 V class	400 VDC	300 to 800 V	Set the bus voltage level to operate the regeneration avoidance operation. When the bus voltage level is set low, it will be harder to generate overvoltage error, but actual deceleration time will be longer. Set the setting value higher than the $(\text{power supply voltage} \times \sqrt{2})$ value.
		400 V class	780 VDC		
885 G123	Regeneration avoidance compensation frequency limit value	6 Hz		0 to 10 Hz	Set the limit value for frequency to rise when the regeneration avoidance function is activated.
				9999	The frequency limit is disabled.
886 G124	Regeneration avoidance voltage gain	100%		0 to 200%	Adjust the response during the regeneration avoidance operation. Increasing the setting improves the response to change in the bus voltage. However, the output frequency may become unstable. If setting a smaller value in Pr.886 does not suppress the vibration, set a smaller value in Pr.665 .
665 G125	Regeneration avoidance frequency gain	100%		0 to 200%	

5

◆ Regeneration avoidance operation (Pr.882, Pr.883)

- When the regenerative voltage increases, the DC bus voltage will rise, which may cause an overvoltage fault (E.OV[]). The regenerative status can be avoided by detecting this rise of bus voltage, and raising the frequency when the bus voltage level exceeds **Pr.883 Regeneration avoidance operation level**.
- The regeneration avoidance operation can be selected to operate constantly or operate only during constant speed.
- The regeneration avoidance function is enabled by setting "1 or 2" in **Pr.882 Regeneration avoidance operation selection**.

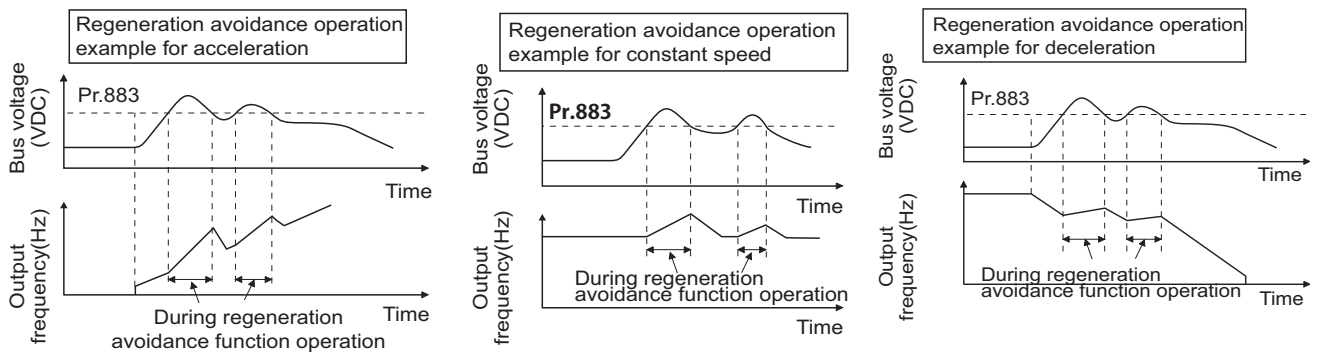

NOTE

- The slope of frequency rising or lowering by the regeneration avoidance operation will change depending on the regenerative status.
- The DC bus voltage of the inverter will be approximately $\sqrt{2}$ times of the normal input voltage.
 The bus voltage is about 311 VDC (622 VDC) when the input voltage is 220 VAC (440 VAC). However, it may vary depending on the input power supply waveform.

- Make sure that the setting value of Pr.883 is not below the DC bus voltage level. The frequency will rise with operation of the regeneration avoidance function even during operation other than the regenerative operation.
- The stall prevention (overvoltage) (OLV) is activated only during deceleration to prevent a decrease in output frequency. The regeneration avoidance function constantly operates (Pr.882 = "1") or operates only at constant speed (Pr.882 = "2"), and raise the frequency in accordance with the amount of regeneration.
- When the motor becomes unstable due to operation of the stall prevention (overcurrent) (OLC) during the regeneration avoidance operation, increase the deceleration time or lower the setting of Pr.883.

◆ Limiting the regeneration avoidance operation frequency (Pr.885)

- It is possible to assign a limit to the output frequency corrected (rise) by the regeneration avoidance operation.
- Limit of the frequency is output frequency (frequency before regeneration avoidance operation) + Pr.885 Regeneration avoidance compensation frequency limit value for during acceleration and constant speed. During deceleration, when the frequency increases due to the regeneration avoidance operation and exceeds the limit value, the limit value will be retained until the output frequency is reduced to be half the Pr.885 setting.
- When the frequency that have increased by the regeneration avoidance operation exceeds Pr.1 Maximum frequency, it will be limited to the maximum frequency.
- When Pr.885 = "9999", the regeneration avoidance compensation frequency limit is disabled.
- Set the frequency around the motor rated slip frequency. Increase the setting value if the overvoltage protection function (E.OV[]) is activated at the start of deceleration.

$$\text{Rated motor slip frequency} = \frac{\text{Synchronized speed at the time of base frequency} - \text{rated rotation speed}}{\text{Synchronized speed at the time of base frequency}} \times \text{Rated motor frequency}$$

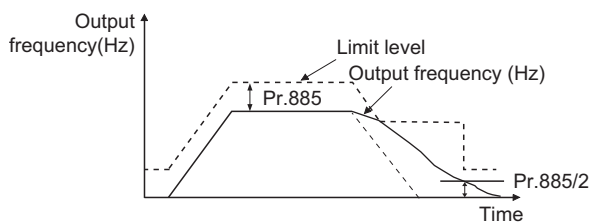

◆ Adjusting the regeneration avoidance operation (Pr.665, Pr.886)

- If the frequency becomes unstable during regeneration avoidance operation, decrease the setting of Pr.886 Regeneration avoidance voltage gain. On the other hand, if an overvoltage fault occurs due to a sudden regeneration, increase the setting.
- If setting a smaller value in Pr.886 does not suppress the vibration, set a smaller value in Pr.665 Regeneration avoidance frequency gain.

NOTE

- During the regeneration avoidance operation, the stall prevention (overvoltage) "OLV" is displayed and the Overload warning (OL) signal is output. Set the operation pattern at an OL signal output using Pr.156 Stall prevention operation level. Set the output timing of the OL signal using Pr.157 OL signal output timer.
- The stall prevention is enabled even during regeneration avoidance operation.
- The regeneration avoidance function cannot decrease the actual deceleration time for the motor to stop. Since the actual deceleration time is determined by the regenerative power consumption performance, consider using a regeneration unit (FR-BU2, FR-CV, FR-HC2) to decrease the deceleration time.
- When using a regeneration unit (FR-BU2, FR-CV, FR-HC2) to consume the regenerative power, set Pr.882 = "0 (initial value)" to disable the regeneration avoidance function. When using a regeneration unit to consume the regenerative power at deceleration, set Pr.882 = "2" to enable regeneration avoidance function only at the constant speed.

Parameters referred to

Pr.1 Maximum frequency [page 117](#)

Pr.8 Deceleration time [page 93](#)

Pr.22 Stall prevention operation level [page 119](#)

5.12.8 Increased magnetic excitation deceleration

Increase the loss in the motor by increasing the magnetic flux during deceleration. The deceleration time can be reduced by suppressing the stall prevention (overvoltage) (OLV).

Pr.	Name	Initial value	Setting range	Description
660 G130	Increased magnetic excitation deceleration operation selection	0	0	Without the increased magnetic excitation deceleration function
			1	With the increased magnetic excitation deceleration function
661 G131	Magnetic excitation increase rate	9999	0 to 40%	Set the increase of excitation.
			9999	The magnetic excitation increase rate is 10%.
662 G132	Increased magnetic excitation current level	100%	0 to 300%	The increased magnetic excitation rate is automatically lowered when the output current exceeds the setting value during increased magnetic excitation deceleration.

◆ Setting of increased magnetic excitation rate (Pr.660, Pr.661)

- To enable the increased magnetic excitation deceleration, set "1" in **Pr.660 Increased magnetic excitation deceleration operation selection**.
- Set the amount of excitation increase in **Pr.661 Magnetic excitation increase rate**. Increased magnetic excitation deceleration is disabled when **Pr.661** = "0".
- When the DC bus voltage exceeds the increased magnetic excitation deceleration operation level during the deceleration, excitation is increased in accordance with the setting value in **Pr.661**.

Inverter	Increased magnetic excitation deceleration operation level
400 V class	680 V

- When the stall prevention (overvoltage) occurs during the increased magnetic excitation deceleration operation, increase the deceleration time or raise the setting value of **Pr.661**. When the stall prevention (overcurrent) occurs, increase the deceleration time or lower the setting value of **Pr.661**.

NOTE

- Increased magnetic excitation deceleration is disabled in the following conditions:
Power failure stop, operation with the FR-HC2/FR-CV, and Optimum excitation control.





◆ Overcurrent prevention function (Pr.662)

- The increased magnetic excitation rate is lowered automatically when the output current exceeds the level set in **Pr.662** during increased magnetic excitation deceleration.
- When the inverter protective function (E.OC[], E.THT) is activated due to increased magnetic excitation deceleration, adjust the level set in **Pr.662**.
- The overcurrent preventive function is disabled when **Pr.662** = "0".

NOTE

- When the level set in **Pr.662** is more than the one set in **Pr.22 Stall prevention operation level**, the overcurrent preventive function is activated at the level set in **Pr.22**. (The level set in **Pr.662** is applied when **Pr.22** = "0".)

Parameters referred to

- Pr.22 Stall prevention operation level  page 119
Pr.30 Regenerative function selection  page 159
Pr.60 Energy saving control selection  page 195
Pr.261 Power failure stop selection  page 160

5.12.9 Slip compensation

The slip of the motor is estimated from the inverter output current to maintain the rotation of the motor constant.

Pr.	Name	Initial value	Setting range	Description
245 G203	Rated slip	9999	0.01 to 50%	Set the rated motor slip.
			0, 9999	No slip compensation
246 G204	Slip compensation time constant	0.5 s	0.01 to 10 s	Set the response time of the slip compensation. Reducing the value improves the response, but the regenerative overvoltage (E.OV[]) error is more likely to occur with a larger load inertia.
247 G205	Constant-output range slip compensation selection	9999	0	No slip compensation in the constant output range (frequency range higher than the frequency set in Pr.3).
			9999	Slip compensation is performed in the constant power range.

- Calculate the rated motor slip and set the value in **Pr.245** to enable slip compensation.

Slip compensation is not performed when **Pr.245** = "0 or 9999".

$$\text{Rated slip} = \frac{\text{Synchronized speed at the time of base frequency} - \text{rated rotation speed}}{\text{Synchronized speed at the time of base frequency}} \times 100 [\%]$$

NOTE

- When the slip compensation is performed, the output frequency may become larger than the set frequency. Set **Pr.1 Maximum frequency** higher than the set frequency.
- Slip compensation will be disabled in the following conditions:
Stall prevention (OLC, OLV) operation, regeneration avoidance operation, auto tuning

Parameters referred to

Pr.1 Maximum frequency  [page 117](#)

Pr.3 Base frequency  [page 194](#)

5.13 Parameter clear / All parameter clear

NOTE

- Set "1" to **Pr.CL Parameter clear** or **ALLC All parameter clear** to initialize parameters. (Parameters cannot be cleared when **Pr.77 Parameter write selection** = "1".)
- Pr.CL does not clear calibration parameters or the terminal function selection parameters.
- Refer to the parameter list on [page 386](#) for parameters to be cleared with this operation.

Operating procedure

1. Turning ON the power of the inverter
The operation panel is in the monitor mode.
2. Selecting the parameter setting mode
Press to choose the parameter setting mode.
3. Selecting the parameter
Press or to display "Pr.CL" for Parameter clear or "ALLC" for All parameter clear, and press . "0" (initial value) appears.
4. Parameter clear
Press or to change the set value to "1". Press to set. "1" and "Pr.CL" ("ALLC") are displayed alternately after parameters are cleared.
 - Press or to read another parameter.
 - Press to show the setting again.
 - Press twice to show the next parameter.

Setting	Description	
	Pr.CL Parameter clear	ALLC All parameter clear
0	Initial display (Parameters are not cleared.)	
1	The settings of parameters except for calibration parameters and terminal function selection parameters are initialized.	The settings of all the parameters, including calibration parameters and terminal function selection parameters, are initialized.









NOTE

- Stop the inverter first. Writing error occurs if parameter clear is attempted while the inverter is running. To clear parameters, the inverter must be in the PU operation mode even if "2" is set to **Pr.77**.
- For availability of the Parameter clear or All parameter clear operation for each parameter, refer to the parameter list on [page 386](#).

5.14 Checking parameters changed from their initial values (initial value change list)

Parameters changed from their initial values can be displayed.

Operating procedure

1. Turning ON the power of the inverter
The operation panel is in the monitor mode.
2. Selecting the parameter setting mode
Press  to choose the parameter setting mode. (The parameter number read previously appears.)
3. Selecting the parameter
Press  or  to display "Pr.[H]" (initial value change list), and press .
"Pr. - - -" appears.
4. Checking the initial value change list
Press  or  to display the parameter numbers that have been changed from their initial value in order.
 - When  is pressed with a changed parameter displayed, the setting change process of the parameter starts. (Parameter numbers are no longer displayed in the list when they are returned to their initial values.)Other changed parameters appear by pressing  or .
 - The indication returns to "Pr. - - -" after the last changed parameter is displayed.

NOTE

- Calibration parameters (C0 (Pr.900) to C7 (Pr.905)) are not displayed even when these are changed from the initial settings.
 - Parameter setting using the initial value change list is also possible.
-

CHAPTER 6 PROTECTIVE FUNCTIONS

- 6.1 Inverter fault and indication.....206
- 6.2 Reset method for the protective functions207
- 6.3 Check and clear of the fault history208
- 6.4 List of fault indications210
- 6.5 Causes and corrective actions.....211
- 6.6 Check first when you have a trouble.....219

6 PROTECTIVE FUNCTIONS

This chapter explains the "PROTECTIVE FUNCTIONS" that operate in this product.

Always read the instructions before use.

6.1 Inverter fault and indication

- When the inverter detects a fault, depending on the nature of the fault, the PU displays an error message or warning, or a protective function is activated to shut off the inverter output.
- When any fault occurs, take an appropriate corrective action, then reset the inverter, and resume the operation. Restarting the operation without a reset may break or damage the inverter.
- When a protective function is activated, note the following points.

Item	Description
Fault signal	Opening the magnetic contactor (MC) provided on the input side of the inverter at a fault occurrence shuts off the control power to the inverter, therefore, the fault output will not be retained.
Fault indication	When a protective function is activated, the PU displays a fault indication.
Operation restart method	While a protective function is activated, the inverter output is kept shutoff. Reset the inverter to restart the operation.

- Inverter fault or alarm indications are categorized as follows:

Displayed item	Description
Error message	A message regarding operational fault and setting fault by PU is displayed. The inverter output is not shut off.
Warning	The inverter output is not shut off even when a warning is displayed. However, failure to take appropriate measures will lead to a fault.
Alarm	The inverter output is not shut off. The Alarm (LF) signal can also be output with a parameter setting.
Fault	A protective function is activated, the inverter output is shut off, and the Fault (ALM) signal is output.

NOTE

- The past eight faults can be displayed on the PU (fault history). (For the operation, refer to [page 208](#).)

6.2 Reset method for the protective functions

Reset the inverter by performing any of the following operations. Note that the accumulated heat value of the electronic thermal relay function and the number of retries are cleared (erased) by resetting the inverter.

The inverter recovers about 1 second after the reset is released.

- Press  on the operation panel to reset the inverter. (This operation is valid only when a protective function for a fault is activated. (Refer to [page 214](#) of the Instruction Manual for faults.))

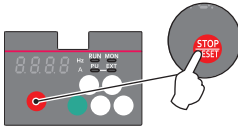

- Switch the power OFF once, then switch it ON again.

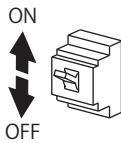

- Turn ON the Reset (RES) signal for 0.1 s or more. (If the RES signal is kept ON, "Err" appears (blinks) to indicate that the inverter is in a reset status.)

NOTE

- OFF status of the start signal must be confirmed before resetting the inverter fault. Resetting an inverter fault with the start signal ON restarts the motor suddenly.

6.3 Check and clear of the fault history

The PU stores the past eight fault records which appears when a protective function is activated (fault history).

◆ Checking the fault history

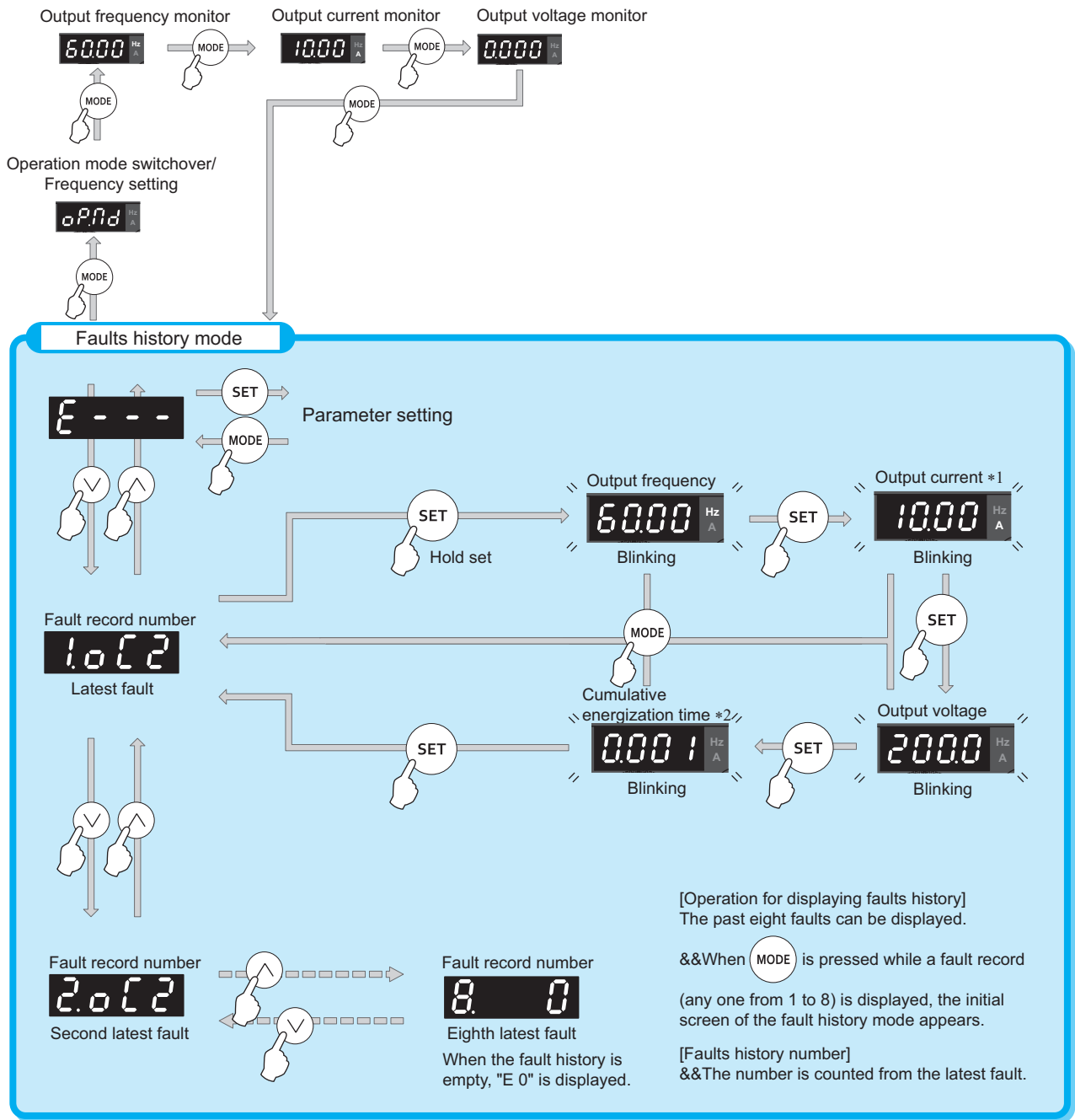

*1 When an overcurrent trip occurs by an instantaneous overcurrent, the monitored current value saved in the fault history may be lower than the actual current that has flowed.

*2 The cumulative energization time and actual operation time are accumulated from 0 to 65535 hours, then cleared, and accumulated again from 0.

◆ Clearing the fault history

Point

- Set Er.CL Fault history clear = "1" to clear the fault history.

Operating procedure



1. Turning ON the power of the inverter

The operation panel is in the monitor mode.



2. Selecting the parameter setting mode

Press  to choose the parameter setting mode. (The parameter number read previously appears.)





3. Selecting the parameter number

Turn  or  until "Er.CL" (Fault history clear) appears. Press  to read the present set value. "0" (initial value)" appears.

4. Fault history clear

Press  or  to change the set value to "1". Press  to start clearing.

"1" and "Er.CL" are displayed alternately after the parameters are cleared.

- Press  or  to read another parameter.
- Press  to show the setting again.
- Press  twice to show the next parameter.

6.4 List of fault indications

If the displayed message does not correspond to any of the following or if you have any other problem, contact your sales representative.

◆ Error message

- A message regarding operational fault and setting fault by PU is displayed. The inverter output is not shut off.

Operation panel indication	Name	Refer to page
HoLd	Operation panel lock	211
LoCd	Password locked	211
Er 1 to Er 4	Parameter write error	211
Err.	Error	212

◆ Warning

- The inverter output is not shut off even when a warning is displayed. However, failure to take appropriate measures will lead to a fault.

Operation panel indication	Name	Refer to page
oLl	Stall prevention (overcurrent)	212
oLv	Stall prevention (overvoltage)	213
rH	Electronic thermal O/L relay pre-alarm	213
PS	PU stop	213
Uu	Undervoltage	213
rH	Inrush current limit resistor overheat	213

◆ Fault

- A protective function is activated, the inverter output is shut off, and the fault (ALM) signal is output.

Operation panel indication	Name	Data Code	Refer to page
EoC1	Overcurrent trip during acceleration	16 (H10)	214
EoC2	Overcurrent trip during constant speed	17 (H11)	214
EoC3	Overcurrent trip during deceleration or stop	18 (H12)	214
Eou1	Regenerative overvoltage trip during acceleration	32 (H20)	215
Eou2	Regenerative overvoltage trip during constant speed	33 (H21)	215
Eou3	Regenerative overvoltage trip during deceleration or	34 (H22)	215



Operation panel indication	Name	Data Code	Refer to page
ErHr	Inverter overload trip (electronic thermal O/L)	48 (H30)	215
ErHn	Motor overload trip (electronic thermal O/L)	49 (H31)	216
ErFn	Heatsink overheat	64 (H40)	216
EUuF	Undervoltage	81 (H51)	216
E.LF	Input phase loss	82 (H52)	
EoLF	Stall prevention stop	96 (H60)	217
EdF	Output side earth (ground) fault overcurrent	128 (H80)	217
ELF	Output phase loss	129 (H81)	217
EoHr	External thermal relay operation	144 (H90)	217
EPE	Parameter storage device fault	176 (HB0)	217
EPE2		179 (HB3)	
EPUE	PU disconnection	177 (HB1)	218
ErEr	Retry count excess	178 (HB2)	218
ECPU	CPU fault	192 (HC0)	218
E.E5		245 (HF5)	
ELdo	Abnormal output current detection	196 (HC4)	218
E.oH	Inrush current limit circuit fault	197 (HC5)	218
ELC1	4 mA input fault	228 (HE4)	219
EE10	Inverter output fault	250 (HFA)	219

If faults other than the above appear, contact your sales representative.

6.5 Causes and corrective actions

◆ Error message

A message regarding operational troubles is displayed. Output is not shut off.

Operation panel indication	HOLD	Hold
Name	Operation panel lock	
Description	Operation lock is set. Operation other than  is invalid. (Refer to page 88.)	
Check point	-----	
Corrective action	Press  for 2 seconds to release the lock.	

Operation panel indication	LOCD	LoCd
Name	Parameter locked	
Description	Password function is active. Display and setting of parameters are restricted.	
Check point	-----	
Corrective action	Enter the password in Pr.297 Password lock/unlock to unlock the password function before the operation. (Refer to page 90.)	

Operation panel indication	Er1	Er 1
Name	Write disable error	
Description	<ul style="list-style-type: none"> Parameter setting was attempted while Pr.77 Parameter write selection is set to disable parameter write. Overlapping range has been set for the frequency jump. Overlapping range has been set for the adjustable 3 points V/F. The PU and the inverter cannot make normal communication. 	
Check point	<ul style="list-style-type: none"> Check the Pr.77 setting. (Refer to page 89.) Check the settings of Pr.31 to Pr.36 (frequency jump). (Refer to page 118.) Check the settings of Pr.100 to Pr.105 (adjustable 3 points V/F). (Refer to page 195.) Check the connection of the PU and the inverter. 	

Operation panel indication	Er2	Er 2
Name	Write error during operation	
Description	Parameter write was attempted while Pr.77 Parameter write selection = "0".	
Check point	<ul style="list-style-type: none"> Check that the inverter is stopped. 	
Corrective action	<ul style="list-style-type: none"> After stopping the operation, make parameter setting. When setting Pr.77 = "2", parameter write is enabled during operation. (Refer to page 89.) 	

Operation panel indication	Er3	Er 3
Name	Calibration error	
Description	Analog input bias and gain calibration values are set too close.	
Check point	Check the settings of the calibration parameters C3, C4, C6, and C7 (calibration functions). (Refer to page 134.)	

Operation panel indication	Er4	Er4
Name	Mode designation error	
Description	<ul style="list-style-type: none"> Parameter setting is attempted in the External or NET operation mode when Pr.77 Parameter write selection = "1". Parameter write is attempted when the command source is not at the operation panel. 	
Check point	<ul style="list-style-type: none"> Check that operation mode is PU operation mode. Check that the Pr.551 PU mode operation command source selection setting is correct. 	
Corrective action	<ul style="list-style-type: none"> After setting the operation mode to the "PU operation mode", set the parameter. (Refer to page 100.) When Pr.77 = "2", parameter write is enabled regardless of the operation mode. (Refer to page 89.) Set Pr.551 = "2". (Refer to page 105.) 	

Operation panel indication	Err.	Err.
Description	<ul style="list-style-type: none"> The RES signal is turned ON. This error may occur when the voltage at the input side of the inverter drops. 	
Corrective action	<ul style="list-style-type: none"> Turn OFF the RES signal. Check the voltage on the input side of the inverter. 	



◆ Warning

Output is not shut off when a protective function is activated.

Operation panel indication	OLC	oLC	FR-LU08 indication	OL
Name	Stall prevention (overcurrent)			
Description	<ul style="list-style-type: none"> When the output current of the inverter increases, the stall prevention (overcurrent) function is activated. The following section explains the stall prevention (overcurrent) function. 			
	During acceleration	When the inverter output current exceeds the stall prevention level (Pr.22 Stall prevention operation level , etc.), this function stops the increase in frequency until the overload current decreases to prevent the inverter from resulting in overcurrent trip. When the overload current is reduced below stall prevention operation level, this function increases the frequency again.		
	During constant-speed operation	When the inverter output current exceeds the stall prevention level (Pr.22 Stall prevention operation level , etc.), this function decreases frequency until the overload current decreases to prevent the inverter from resulting in overcurrent trip. When the overload current is reduced below stall prevention operation level, this function increases the frequency up to the set value.		
	During deceleration	When the inverter output current exceeds the stall prevention level (Pr.22 Stall prevention operation level , etc.), this function stops the decrease in frequency until the overload current decreases to prevent the inverter from resulting in overcurrent trip. When the overload current is reduced below stall prevention operation level, this function decreases the frequency again.		
Check point	<ul style="list-style-type: none"> Check that the Pr.0 Torque boost setting is not too large. The Pr.7 Acceleration time and Pr.8 Deceleration time settings may be too short. Check that the load is not too heavy. Check for any failures in peripheral devices. Check that Pr.13 Starting frequency is not too large. Check that Pr.22 Stall prevention operation level is appropriate. 			
Corrective action	<ul style="list-style-type: none"> Gradually increase or decrease the Pr.0 setting by 1% at a time and check the motor status. (Refer to page 193.) Set a larger value in Pr.7 and Pr.8. (Refer to page 93.) Reduce the load. Try General-purpose magnetic flux vector control. The stall prevention operation current can be set in Pr.22 Stall prevention operation level. (Initial value is 150%.) Acceleration/deceleration time may change. Increase the stall prevention operation level with Pr.22 Stall prevention operation level, or disable stall prevention with Pr.156 Stall prevention operation selection. (Use Pr.156 to set either operation continued or not at OL operation.) 			

Operation panel indication	OLV	<i>oLv</i>	FR-LU08 indication	oL
Name	Stall prevention (overvoltage)			
Description	<ul style="list-style-type: none"> When the output voltage of the inverter increases, the stall prevention (overvoltage) function is activated. The regeneration avoidance function is activated due to excessive regenerative power of the motor. (Refer to page 199.) The following section explains the stall prevention (overvoltage) function. 			
	During deceleration	If the regenerative power of the motor exceeds the regenerative power consumption capability, this function stops decreasing the frequency to prevent overvoltage trip. As soon as the regenerative power has reduced, deceleration resumes.		
Check point	<ul style="list-style-type: none"> Check for sudden speed reduction. Check if the regeneration avoidance function (Pr.882, Pr.883, Pr.885, Pr.886) is enabled. (Refer to page 199.) 			
Corrective action	The deceleration time may change. Increase the deceleration time using Pr.8 Deceleration time .			

Operation panel indication	TH	<i>TH</i>	FR-LU08 indication	TH
Name	Electronic thermal O/L relay pre-alarm			
Description	Appears if the cumulative value of the electronic thermal O/L relay reaches or exceeds 85% of the preset level of Pr.9 Electronic thermal O/L relay . If the value reaches 100% of Pr.9 setting, motor overload trip (electronic thermal O/L relay) (E.THM) occurs.			
Check point	<ul style="list-style-type: none"> Check for large load or sudden acceleration. Check that the Pr.9 setting is appropriate. (Refer to page 112.) 			
Corrective action	<ul style="list-style-type: none"> Reduce the load and frequency of operation. Set an appropriate value in Pr.9. (Refer to page 112.) 			

Operation panel indication	PS	<i>PS</i>	FR-LU08 indication	PS
Name	PU stop			
Description	<ul style="list-style-type: none"> The motor is stopped using  under the mode other than the PU operation mode. (To enable  under the mode other than the PU operation mode, set Pr.75 Reset selection/disconnected PU detection/PU stop selection. Refer to page 85 for details.) The motor is stopped by the emergency stop function. 			
Check point	<ul style="list-style-type: none"> Check if the motor is stopped by pressing  on the operation panel. 			
Corrective action	<ul style="list-style-type: none"> Turn OFF the start signal and switch the operation mode to the PU operation mode. 			

Operation panel indication	UV	<i>Uu</i>	FR-LU08 indication	—
Name	Undervoltage			
Description	If the power supply voltage of the inverter decreases, the control circuit will not perform normal functions. In addition, the motor torque will be insufficient and/or heat generation will increase. To prevent this, if the power supply voltage decreases to about 115 VAC (230 VAC for the 400 V class) or below, this function shuts off the inverter output.			
Check point	<ul style="list-style-type: none"> Check that the power supply voltage is appropriate. Check if a high-capacity motor is driven. 			
Corrective action	Investigate the devices on the power supply line such as the power supply itself.			

Operation panel indication	IH	<i>I H</i>	FR-LU08 indication	—
Name	Inrush current limit resistor overheat			
Description	The inrush current limit resistor is a PTC thermistor. Resistance of the PTC thermistor is increased when power ON/OFF is repeated. When the resistance is increased, a huge gap between the peak voltage and the bus voltage is generated and the gap may cause a large inrush current flow. The surge voltage causes overvoltage error and the inverter displays a warning indication.			
Check point	<ul style="list-style-type: none"> Check that power ON/OFF is not repeated frequently. Check that the inrush current limit circuit is not damaged. 			
Corrective action	Configure a circuit where frequent power ON/OFF is not repeated. If the problem still persists after taking the above measure, contact your sales representative.			

◆ Fault

When a protective function is activated, the inverter output is shut off and a fault signal is output.

Operation panel indication	E.OC1		FR-LU08 indication	Overcurrent trip during acceleration
Name	Overcurrent trip during acceleration			
Description	When the inverter output current reaches or exceeds approximately 200% of the rated current during acceleration, the protection circuit is activated and the inverter output is shut off.			
Check point	<ul style="list-style-type: none"> • Check for sudden speed acceleration. • Check if the downward acceleration time is too long in a lift application. • Check for output short-circuit. • Check that the Pr.3 Base frequency setting is not 60 Hz when the motor rated frequency is 50 Hz. • Check if the stall prevention operation level is set too high. Check if the fast-response current limit operation is disabled. • Check that the regenerative driving is not performed frequently. (Check if the output voltage becomes larger than the V/F reference voltage at regenerative driving and overcurrent occurs due to increase in the motor current.) 			
Corrective action	<ul style="list-style-type: none"> • Set the acceleration time longer. (Shorten the downward acceleration time of the lift.) • If "E.OC1" always appears at start, disconnect the motor once and restart the inverter. If "E.OC1" still appears, contact your sales representative. • Check the wiring to make sure that output short circuit does not occur. • Set 50 Hz in Pr.3 Base frequency. (Refer to page 194.) • Lower the stall prevention operation level. Activate the fast-response current limit operation. (Refer to page 119.) • Set the base voltage (rated motor voltage, etc.) in Pr.19 Base frequency voltage. (Refer to page 194.) 			

Operation panel indication	E.OC2		FR-LU08 indication	Overcurrent trip during constant speed
Name	Overcurrent trip during constant speed			
Description	When the inverter output current reaches or exceeds approximately 200% of the rated current during constant-speed operation, the protection circuit is activated and the inverter output is shut off.			
Check point	<ul style="list-style-type: none"> • Check for sudden load change. • Check for output short-circuit. • Check if the stall prevention operation level is set too high. Check if the fast-response current limit operation is disabled. 			
Corrective action	<ul style="list-style-type: none"> • Keep the load stable. • Check the wiring to make sure that output short circuit does not occur. • Lower the stall prevention operation level. Activate the fast-response current limit operation. (Refer to page 119.) 			

Operation panel indication	E.OC3		FR-LU08 indication	OC During Dec
Name	Overcurrent trip during deceleration or stop			
Description	When the inverter output current reaches or exceeds approximately 200% of the rated current during deceleration (other than acceleration or constant speed), the protection circuit is activated and the inverter output is shut off.			
Check point	<ul style="list-style-type: none"> • Check for sudden speed reduction. • Check for output short-circuit. • Check for too fast operation of the motor's mechanical brake. • Check if the stall prevention operation level is set too high. Check if the fast-response current limit operation is disabled. 			
Corrective action	<ul style="list-style-type: none"> • Set the deceleration time longer. • Check the wiring to make sure that output short circuit does not occur. • Check the mechanical brake operation. • Lower the stall prevention operation level. Activate the fast-response current limit operation. (Refer to page 119.) 			

Operation panel indication	E.OV1	<i>E.OV1</i>	FR-LU08 indication	OV During Acc
Name	Regenerative overvoltage trip during acceleration			
Description	If regenerative power causes the inverter's internal main circuit DC voltage to reach or exceed the specified value, the protection circuit is activated to stop the inverter output. The circuit may also be activated by a surge voltage produced in the power supply system.			
Check point	<ul style="list-style-type: none"> • Check for too slow acceleration. (e.g. during downward acceleration in vertical lift load) • Check that the Pr.22 Stall prevention operation level is not set to the no load current or lower. • Check if the stall prevention operation is frequently activated in an application with a large load inertia. 			
Corrective action	<ul style="list-style-type: none"> • Set the acceleration time shorter. • Use the regeneration avoidance function (Pr.882, Pr.883, Pr.885, Pr.886). (Refer to page 199.) • Set a value larger than the no load current in Pr.22. 			

Operation panel indication	E.OV2	<i>E.OV2</i>	FR-LU08 indication	Steady spd OV
Name	Regenerative overvoltage trip during constant speed			
Description	If regenerative power causes the inverter's internal main circuit DC voltage to reach or exceed the specified value, the protection circuit is activated to stop the inverter output. The circuit may also be activated by a surge voltage produced in the power supply system.			
Check point	<ul style="list-style-type: none"> • Check for sudden load change. • Check that the Pr.22 Stall prevention operation level is not set to the no load current or lower. • Check if the stall prevention operation is frequently activated in an application with a large load inertia. • Check that acceleration/deceleration time is not too short. 			
Corrective action	<ul style="list-style-type: none"> • Keep the load stable. • Use the regeneration avoidance function (Pr.882, Pr.883, Pr.885, Pr.886). (Refer to page 199.) • Use a brake unit or the power regeneration common converter (FR-CV) as required. • Set a value larger than the no load current in Pr.22. • Set the acceleration/deceleration time longer. (Under General-purpose magnetic flux vector, the output torque can be increased. However, sudden acceleration may cause an overshoot in speed, resulting in an occurrence of overvoltage.) 			

Operation panel indication	E.OV3	<i>E.OV3</i>	FR-LU08 indication	OV During Acc
Name	Regenerative overvoltage trip during deceleration or stop			
Description	If regenerative power causes the inverter's internal main circuit DC voltage to reach or exceed the specified value, the protection circuit is activated to stop the inverter output. The circuit may also be activated by a surge voltage produced in the power supply system.			
Check point	<ul style="list-style-type: none"> • Check for sudden speed reduction. • Check if the stall prevention operation is frequently activated in an application with a large load inertia. 			
Corrective action	<ul style="list-style-type: none"> • Set the deceleration time longer. (Set the deceleration time which matches the moment of inertia of the load.) • Make the brake cycle longer. • Use the regeneration avoidance function (Pr.882, Pr.883, Pr.885, Pr.886). (Refer to page 199.) • Use the brake unit or power regeneration common converter (FR-CV) as required. • Enable the increased magnetic excitation deceleration. 			

Operation panel indication	E.THT	<i>E.THT</i>	FR-LU08 indication	Inv. Overload
Name	Inverter overload trip (electronic thermal O/L relay function) ^{*1}			
Description	If the temperature of the output transistor elements exceeds the protection level with a rated output current or higher flowing without the overcurrent trip (E.OC[]), the inverter output is stopped. (Overload capacity 150% 60 s)			
Check point	<ul style="list-style-type: none"> • Check that acceleration/deceleration time is not too short. • Check that torque boost setting is not too large (small). • Check that load pattern selection setting is appropriate for the load pattern of the machine. • Check that the motor is not used under overload. 			
Corrective action	<ul style="list-style-type: none"> • Set the acceleration/deceleration time longer. • Adjust the torque boost setting. • Set the load pattern selection setting according to the load pattern of the using machine. • Reduce the load. 			

*1 Resetting the inverter initializes the internal cumulative heat value of the electronic thermal relay function.

Operation panel indication	E.THM	<i>E.THM</i>	FR-LU08 indication	Motor Ovrload
Name	Motor overload trip (electronic thermal O/L relay function) ^{*2}			
Description	The electronic thermal relay function in the inverter detects motor overheat, which is caused by overload or reduced cooling capability, during low-speed operation. When the cumulative heat value reaches 85% of the Pr.9 Electronic thermal O/L relay setting, pre-alarm (TH) is output. When the integrated value reaches the specified value, the protection circuit is activated to stop the inverter output. When the inverter is used to drive a dedicated motor such as a multiple-pole motor, or several motors, the motors cannot be protected by the electronic thermal O/L relay. In such cases, install an external thermal relay on the inverter output side.			
Check point	<ul style="list-style-type: none"> • Check if the motor is not used under overload. • Check that the setting of Pr.71 Applied motor for motor selection is correct. (Refer to page 147.) • Check that the stall prevention operation setting is correct. 			
Corrective action	<ul style="list-style-type: none"> • Reduce the load. • For a constant-torque motor, set the constant-torque motor in Pr.71 Applied motor. • Set the stall prevention operation level accordingly. (Refer to page 119.) 			

*2 Resetting the inverter initializes the internal cumulative heat value of the electronic thermal relay function.

Operation panel indication	E.FIN	<i>E.FIN</i>	FR-LU08 indication	H/Sink O/Temp
Name	Heatsink overheat			
Description	When the heatsink overheats, the temperature sensor is activated, and the inverter output is stopped. The FIN signal can be output when the temperature becomes approximately 85% of the heatsink overheat protection operation temperature. For the terminal used for the FIN signal output, assign the function by setting "26 (positive logic) or 126 (negative logic)" in Pr.195 (output terminal function selection) . (Refer to page 126.)			
Check point	<ul style="list-style-type: none"> • Check for too high surrounding air temperature. • Check for heatsink clogging. • Check that the cooling system is not stopped. 			
Corrective action	<ul style="list-style-type: none"> • Set the surrounding air temperature to within the specifications. • Clean the heatsink. • If the problem still persists after taking the above measure, contact your sales representative. 			

Operation panel indication	E.UVT	<i>E.UVT</i>	FR-LU08 indication	Under Voltage
Name	Undervoltage			
Description	If the power supply voltage of the inverter decreases, the control circuit will not perform normal functions. In addition, the motor torque will be insufficient and/or heat generation will increase. To prevent this, if the power supply voltage decreases to about 150 VAC (300 VAC for the 400 V class) or below, this function shuts off the inverter output. (Refer to page 159.)			
Check point	<ul style="list-style-type: none"> • Check if a high-capacity motor is driven. 			
Corrective action	<ul style="list-style-type: none"> • Check the devices on the power supply line such as the power supply itself. • If the problem still persists after taking the above measure, contact your sales representative. 			

Operation panel indication	E.ILF	<i>E.ILF</i>	FR-LU08 indication	Input phase loss
Name	Input phase loss ^{*3}			
Description	When Pr.872 Input phase loss protection selection is enabled ("1") and one of the three-phase power input is lost, the inverter output is shut off. Whether the protective function is used or not is set with Pr.872 . It may function if phase-to-phase voltage of the three-phase power input becomes largely unbalanced.			
Check point	<ul style="list-style-type: none"> • Check if a high-capacity motor is driven. • Check that phase-to-phase voltage of the three-phase power input is not largely unbalanced. 			
Corrective action	<ul style="list-style-type: none"> • Wire the cables properly. • Check the Pr.872 setting. 			

*3 Available only for three-phase power input specification model.

Operation panel indication	E.OLT	<i>E.OLT</i>	FR-LU08 indication	Stall Prev STP
Name	Stall prevention stop			
Description	If the output frequency has fallen to 1 Hz by stall prevention operation and remains for 3 seconds, a fault (E.OLT) appears and the inverter is shut off. OLC appears while stall prevention is being activated.			
Check point	<ul style="list-style-type: none"> • Check if the motor is not used under overload. 			
Corrective action	<ul style="list-style-type: none"> • Reduce the load. • Change the Pr.22 setting. • Also check that the stall prevention (overcurrent) warning (OLC) or the stall prevention (overvoltage) warning (OLV) countermeasure is taken. 			

Operation panel indication	E.GF	<i>EGF</i>	FR-LU08 indication	Ground Fault
Name	Output side earth (ground) fault overcurrent			
Description	The inverter output is shut off if an earth (ground) fault overcurrent flows due to an earth (ground) fault that occurred on the inverter's output side (load side). Whether the protective function is used or not is set with Pr.249 Earth (ground) fault detection at start .			
Check point	Check for a ground fault in the motor and connection cable.			
Corrective action	<ul style="list-style-type: none"> • Remedy the earth (ground) fault portion. • Check the Pr.249 setting. 			

Operation panel indication	E.LF	<i>ELF</i>	FR-LU08 indication	Output phase loss
Name	Output phase loss			
Description	The inverter output is shut off if one of the three phases (U, V, W) on the inverter's output side (load side) is lost. Whether the protective function is used or not is set with Pr.251 Output phase loss protection selection .			
Check point	<ul style="list-style-type: none"> • Check the wiring. (Check that the motor is operating normally.) • Check that the capacity of the motor used is not smaller than that of the inverter. 			
Corrective action	<ul style="list-style-type: none"> • Wire the cables properly. • Check the Pr.251 setting. 			

Operation panel indication	E.OHT	<i>E.OHT</i>	FR-LU08 indication	Ext TH relay oper
Name	External thermal relay operation			
Description	The inverter output is shut off if the external thermal relay provided for motor overheat protection or the internally mounted thermal relay in the motor, etc. switches ON (contacts open). This function is available when "7" (OH signal) is set in any of Pr.178 to Pr.182 (input terminal function selection) . This protective function is not available in the initial status. (OH signal is not assigned.)			
Check point	<ul style="list-style-type: none"> • Check for motor overheating. • Check that the value "7" (OH signal) is set correctly to any of Pr.178 to Pr.182 (input terminal function selection). 			
Corrective action	<ul style="list-style-type: none"> • Reduce the load and operation duty. • Even if the relay contacts are reset automatically, the inverter will not restart unless it is reset. 			

Operation panel indication	E.PE	<i>EPE</i>	FR-LU08 indication	Corrupt Memory
	E.PE2	<i>EPE2</i>		PR storage alarm
Name	Parameter storage device fault			
Description	The inverter output is shut off if a fault occurs in the stored parameters. (EEPROM failure)			
Check point	Check for too many number of parameter write times.			
Corrective action	Contact your sales representative. When performing parameter writing frequently for communication purposes, set "1" in Pr.342 Communication EEPROM write selection to enable RAM write. Note that writing to RAM goes back to the initial status at power OFF.			

Operation panel indication	E.PUE	<i>E.PUE</i>	FR-LU08 indication	PU disconnection
Name	PU disconnection			
Description	<ul style="list-style-type: none"> The inverter output is shut off if communication between the inverter and PU is suspended, e.g. the PU is disconnected, when the disconnected PU detection function is activated using Pr.75 Reset selection/disconnected PU detection/PU stop selection. The inverter output is shut off if communication errors occurred consecutively for more than permissible number of retries when Pr.121 PU communication retry count ≠ "9999" during the RS-485 communication via the PU connector. The inverter output is shut off if communication is broken within the period of time set in Pr.122 PU communication check time interval during the RS-485 communication via the PU connector. 			
Check point	<ul style="list-style-type: none"> Check that the PU is connected properly. Check the Pr.75 setting. 			
Corrective action	Connect the PU securely.			

Operation panel indication	E.RET	<i>E.rEt</i>	FR-LU08 indication	Retry count excess
Name	Retry count excess			
Description	The inverter output is shut off if the operation cannot be resumed properly within the number of retries set in Pr.67 Number of retries at fault occurrence . This protective function is available when Pr.67 is set. This protective function is not available in the initial setting (Pr.67 = "0").			
Check point	Find the cause of the fault occurrence.			
Corrective action	Eliminate the cause of the fault preceding this fault indication.			

Operation panel indication	E.CPU	<i>E.CPU</i>	FR-LU08 indication	CPU fault
	E.5	<i>E.ES</i>		Error5
Name	CPU fault			
Description	The inverter output is shut off if a communication fault of the built-in CPU occurs.			
Check point	Check for devices producing excess electrical noises around the inverter.			
Corrective action	<ul style="list-style-type: none"> Take measures against noises if there are devices producing excess electrical noises around the inverter. Contact your sales representative. 			

Operation panel indication	E.CDO	<i>E.Cdo</i>	FR-LU08 indication	OC detect level
Name	Abnormal output current detection			
Description	The inverter output is shut off if the output current exceeds the Pr.150 Output current detection level setting. This function is active when Pr.167 Output current detection operation selection is set to "1." When the initial value (Pr.167 = "0") is set, this protective function is not available.			
Check point	Check the settings of Pr.150, Pr.151 Output current detection signal delay time, and Pr.167 . (Refer to page 129 .)			

Operation panel indication	E.IOH	<i>E. OH</i>	FR-LU08 indication	Inrush overheat
Name	Inrush current limit circuit fault			
Description	The inverter output is shut off when the resistor of the inrush current limit circuit is overheated. The inrush current limit circuit is faulty.			
Check point	<ul style="list-style-type: none"> Check that frequent power ON/OFF is not repeated. Check that the inrush current limit circuit is not damaged. 			
Corrective action	Configure a circuit where frequent power ON/OFF is not repeated. If the problem still persists after taking the above measure, contact your sales representative.			

Operation panel indication	E.LCI	<i>E.L.C.I.</i>	FR-LU08 indication	4 mA input fault
Name	4 mA input fault			
Description	The inverter output is shut off when the analog input current is 2 mA or less for the time set in Pr.778 4 mA input check filter . This function is available when Pr.573 4 mA input check selection = "2 or 3". (Refer to page 139 .) This protective function is not available in the initial status.			
Check point	<ul style="list-style-type: none"> • Check for a break in the wiring for the analog current input. • Check that the Pr.778 setting is not too short. 			
Corrective action	<ul style="list-style-type: none"> • Check the wiring for the analog current input. • Set the Pr.778 setting larger. 			

Operation panel indication	E.E10	<i>E.E 10</i>	FR-LU08 indication	—
Name	Inverter output fault			
Description	The inverter output is shutoff when a fault occurred on the inverter output side (load side) during operation when "1 (initial value)" is set in Pr.631 Inverter output fault detection enable/disable selection. The inverter may not be able to detect errors when the carrier frequency or running frequency is too high.			
Check point	Check for a ground fault in the motor and connection cable.			
Corrective action	<ul style="list-style-type: none"> • Remedy the earth (ground) fault portion. • Check the Pr.631 setting. 			

*4 Available for the FR-CS84-160 or lower or the FR-CS82S.

NOTE

- If protective functions with indication of "Fault" on the FR-LU08 or FR-PU07 are activated, "ERR" appears in the fault history of the FR-LU08 or FR-PU07.
- If faults other than the above appear, contact your sales representative.



6.6 Check first when you have a trouble

Point

- If the cause is still unknown after every check, it is recommended to initialize the parameters, set the required parameter values and check again.

6.6.1 Motor does not start

Check point	Possible cause	Countermeasure	Refer to page
Main circuit	An appropriate power supply voltage is not applied. (The operation panel display is not operating.)	Power on a molded case circuit breaker (MCCB), an earth leakage circuit breaker (ELB), or a magnetic contactor (MC).	—
		Check for the decreased input voltage, input phase loss, and wiring.	—
	The motor is not connected properly.	Check the wiring between the inverter and the motor. If the commercial power supply-inverter switchover function is active, check the wiring of the magnetic contactor (MC) between the inverter and the motor.	31

Check point	Possible cause	Countermeasure	Refer to page
Input signal	A start signal is not input.	Check the start command source, and input a start signal. PU operation mode:  External operation mode: STF/STR signal	103
	Both the forward and reverse rotation start signals (STF, STR) are input simultaneously.	Turn ON only one of the forward and reverse rotation start signals (STF or STR). When the STF and STR signals are turned ON simultaneously in the initial setting, a stop command is given.	35
	Frequency command is zero. (The [RUN] LED indicator on the operation panel is blinking.)	Check the frequency command source and input a frequency command.	103
	The Terminal 4 input selection (AU) signal is not ON when terminal 4 is used for frequency setting. (The [RUN] LED indicator on the operation panel is blinking.)	Turn ON the AU signal. Turning ON the AU signal activates terminal 4 input.	131
	The Output stop (MRS) signal or the Inverter reset (RES) signal is ON. (The [RUN] LED indicator on the operation panel is blinking.)	Turn the MRS or RES signal OFF. The inverter starts the operation with a given start command and a frequency command after turning OFF the MRS or RES signal. Before turning OFF, ensure the safety.	35
	The jumper connector for selecting sink logic or source logic is incorrectly installed. (The [RUN] LED indicator on the operation panel is blinking.)	Check that the control logic switchover jumper connector is correctly installed. If it is not installed correctly, the input signal is not recognized.	36
	The voltage/current input switch is not correctly set for the analog input signal (0 to 5 V, 0 to 10 V, or 4 to 20 mA). (The [RUN] LED indicator on the operation panel is blinking.)	Set Pr.267 Terminal 4 input selection , and a voltage/current input switch correctly, then input an analog signal in accordance with the setting.	131
The  key was pressed. (The operation panel indication is "PS" (PS).)	During the External operation mode, check the method of restarting from a  input stop from PU.	87, 213	

Check point	Possible cause	Countermeasure	Refer to page
Parameter setting	Pr.0 Torque boost setting is improper when V/F control is used.	Increase the Pr.0 setting by 0.5% increments while observing the rotation of a motor. If that makes no difference, decrease the setting.	193
	Pr.78 Reverse rotation prevention selection is set.	Check the Pr.78 setting. Set Pr.78 to limit the motor rotation to only one direction.	108
	Pr.79 Operation mode selection setting is incorrect.	Select the operation mode suitable for the input methods of the start command and frequency command.	100
	The bias and gain (the calibration parameter C2 to C7) settings are not appropriate.	Check the bias and gain (the calibration parameter C2 to C7) settings.	134
	The Pr.13 Starting frequency setting is greater than the running frequency.	Set the running frequency higher than the one set in Pr.13. The inverter does not start if the frequency setting signal has a value lower than that of Pr.13.	99, 93
	Zero is set in various running frequency settings (such as for multi-speed operation). Especially, Pr.1 Maximum frequency is zero.	Set the frequency command according to the application. Set Pr.1 equal to or higher than the actual frequency used.	109, 117
	Pr.15 Jog frequency is lower than Pr.13 Starting frequency during JOG operation.	The Pr.15 setting should be equal to or higher than the Pr.13 setting.	99, 108
	Operation mode and a writing device do not correspond.	Check Pr.79 Operation mode selection, Pr.338 Communication operation command source, Pr.339 Communication speed command source, and Pr.551 PU mode operation command source selection, and select an operation mode suitable for the purpose.	100, 105
	The start signal operation selection is set by Pr.250 Stop selection.	Check the Pr.250 setting and the connection of the STF and STR signals.	145
	The motor has decelerated to a stop when the power failure deceleration stop function is selected.	When power is restored, ensure the safety, and turn OFF the start signal once, then turn ON again to restart. When Pr.261 Power failure stop selection = "2", the motor automatically restarts after the power is restored.	160
	Auto tuning is being performed.	When offline auto tuning ends, press the  key of the operation panel for the PU operation. For the External operation, turn OFF the start signal (STF or STR). This operation resets the offline auto tuning, and the PU's monitor display returns to the normal indication. (Without this operation, next operation cannot be started.)	147
The automatic restart after instantaneous power failure function or power failure stop function has been activated. (Performing overload operation during input phase loss may cause voltage insufficiency, and that may result in detection of power failure.)	Disable the automatic restart after instantaneous power failure function and power failure stop function. Reduce the load. Increase the acceleration time if the function was activated during acceleration.	115, 159, 160	
Load	Load is too heavy.	Reduce the load.	—
	The shaft is locked.	Inspect the machine (motor).	—

6.6.2 Motor or machine is making abnormal acoustic noise

Check point	Possible cause	Countermeasure	Refer to page
Input signal	Disturbance due to EMI when the frequency or torque command is given through analog input terminal 2 or 4.	Take countermeasures against EMI.	48
Parameter setting		Increase the Pr.74 Input filter time constant if steady operation cannot be performed due to EMI or the like.	134
Parameter setting	No carrier frequency noises (metallic noises) are generated.	In the initial setting, Pr.240 Soft-PWM operation selection is enabled to change motor noise to an unoffending complex tone. Therefore, no carrier frequency noises (metallic noises) are generated. Set Pr.240 = "0" to disable this function.	92
	Resonance occurs. (output frequency)	Set Pr.31 to Pr.36 (Frequency jump) . When it is desired to avoid resonance attributable to the natural frequency of a mechanical system, these parameters allow resonant frequencies to be jumped.	118
	Resonance occurs. (carrier frequency)	Change the Pr.72 PWM frequency selection setting. Changing the PWM carrier frequency produces an effect on avoiding the resonance frequency of a mechanical system or a motor.	92
	Auto tuning is not performed under General-purpose magnetic flux vector control.	Perform offline auto tuning	147
	Gain adjustment during PID control is insufficient.	To stabilize the measured value, change the proportional band (Pr.129) to a larger value, the integral time (Pr.130) to a slightly longer time, and the differential time (Pr.134) to a slightly shorter time. Check the calibration of set point and measured value.	152
Others	Mechanical looseness	Adjust machine/equipment so that there is no mechanical looseness.	—
	Contact the motor manufacturer.		
Motor	Operating with output phase loss.	Check the motor wiring.	—

6.6.3 Motor generates heat abnormally

Check point	Possible cause	Countermeasure	Refer to page
Motor	The motor fan is not working. (Dust is accumulated.)	Clean the motor fan. Improve the environment.	—
	Phase to phase insulation of the motor is insufficient.	Check the insulation of the motor.	—
Main Circuit	The inverter output voltage (U, V, W) are unbalanced.	Check the output voltage of the inverter. Check the insulation of the motor.	232
Parameter setting	Pr.71 Applied motor setting is incorrect.	Check the Pr.71 Applied motor setting.	147
—	Motor current is too large	Refer to "6.6.11 Motor current is too large".	225

6.6.4 Motor rotates in the opposite direction

Check point	Possible cause	Countermeasure	Refer to page
Main Circuit	The phase sequence of output terminals U, V and W is incorrect.	Connect the output side terminals (terminals U, V, and W) correctly.	31
Input signal	The start signals (STF and STR signals) are connected improperly.	Check the connection. (STF: forward rotation, STR: reverse rotation)	35, 145
	The polarity of the frequency command is negative during the polarity reversible operation set by Pr.73 Analog input selection .	Check the polarity of the frequency command.	131

6.6.5 Speed greatly differs from the setting

Check point	Possible cause	Countermeasure	Refer to page
Input signal	The frequency setting signal is incorrect.	Measure the input signal level.	—
	The input signal lines are affected by external EMI.	Take countermeasures against EMI, such as using shielded wires for input signal lines.	50
Parameter setting	Pr.1 Maximum frequency, Pr.2 Minimum frequency, Pr.18 High speed maximum frequency, and calibration parameters C2 to C7 settings are not appropriate.	Check the settings of Pr.1, Pr.2, and Pr.18.	117
		Check the calibration parameter C2 to C7 settings.	134
	Pr.31 to Pr.36 (frequency jump) settings are not appropriate.	Narrow down the range of frequency jump.	118
Load	The stall prevention function is activated due to a heavy load.	Reduce the load weight.	—
Parameter setting		Set Pr.22 Stall prevention operation level higher according to the load. (If Pr.22 is set too high, an overcurrent trip (E.OC[]) is likely to occur.)	119
Motor		Check the capacities of the inverter and the motor.	—

6.6.6 Acceleration/deceleration is not smooth

6

Check point	Possible cause	Countermeasure	Refer to page
Parameter setting	The acceleration/deceleration time is too short.	Set the acceleration/deceleration time longer.	93
	Torque boost (Pr.0) setting is improper under the V/F control, so the stall prevention function is activated.	Increase/decrease the Pr.0 Torque boost setting value by 0.5% increments so that stall prevention does not occur.	193
	The base frequency does not match the motor characteristics.	Under V/F control, set Pr.3 Base frequency.	194
	Regeneration avoidance operation is performed.	If the frequency becomes unstable during regeneration avoidance operation, decrease the setting of Pr.886 Regeneration avoidance voltage gain.	199
Load	The stall prevention function is activated due to a heavy load.	Reduce the load.	—
Parameter setting		Set Pr.22 Stall prevention operation level higher according to the load. (If Pr.22 is set too high, an overcurrent trip (E.OC[]) is likely to occur.)	119
Motor		Check the capacities of the inverter and the motor.	—

6.6.7 Speed varies during operation

Check point	Possible cause	Countermeasure	Refer to page
Load	The load varies during an operation.	Select General-purpose magnetic flux vector control.	—
Input signal	The frequency setting signal is varying.	Check the frequency setting signal.	—
	The frequency setting signal is affected by EMI.	Set filter to the analog input terminal using Pr.74 Input filter time constant .	134
		Take countermeasures against EMI, such as using shielded wires for input signal lines.	50
	A malfunction is occurring due to the undesirable current generated when the transistor output unit is connected.	Use terminal PC (terminal SD when source logic) as a common terminal to prevent a malfunction caused by undesirable current.	37
A multi-speed command signal is chattering.	Take countermeasures to suppress chattering.	—	
Parameter setting	Fluctuation of power supply voltage is too large.	Under V/F control, change the Pr.19 Base frequency voltage setting (approximately by 3%).	194
	Wiring length exceeds 30 m when General-purpose magnetic flux vector control is performed.	Perform offline auto tuning	147
	Under V/F control, wiring is too long and a voltage drop occurs.	Adjust the Pr.0 Torque boost setting by increasing with 0.5% increments for the low-speed operation.	193
		Change to General-purpose magnetic flux vector control.	—
	Hunting occurs by the generated vibration, for example, when structural rigidity of the load is insufficient.	Disable automatic control functions, such as fast-response current limit function, regeneration avoidance function, and General-purpose magnetic flux vector control. For PID control, set smaller values to Pr.129 PID proportional band and Pr.130 PID integral time . Lower the control gain to increase the stability.	—
Change the Pr.72 PWM frequency selection setting.		92	

6.6.8 Operation mode is not changed properly

Check point	Possible cause	Countermeasure	Refer to page
Input signal	The start signal (STF or STR) is ON.	Check that the STF and STR signals are OFF. When either is ON, the operation mode cannot be changed.	35, 145
Parameter setting	The Pr.79 Operation mode selection setting is not appropriate.	When Pr.79 setting is "0 (initial value)", the inverter is placed in the External operation mode at input power ON and can be switched to the PU operation mode. At other settings (1 to 4), the operation mode is limited accordingly.	100
	Operation mode and a writing device do not correspond.	Check Pr.79 Operation mode selection, Pr.338 Communication operation command source, Pr.339 Communication speed command source, and Pr.551 PU mode operation command source selection , and select an operation mode suitable for the purpose.	100, 105

6.6.9 The motor current is too large

Check point	Possible cause	Countermeasure	Refer to page
Parameter setting	Torque boost (Pr.0) setting is improper under the V/F control, so the stall prevention function is activated.	Increase/decrease the Pr.0 Torque boost setting value by 0.5% increments so that stall prevention does not occur.	193
	The V/F pattern is not appropriate when V/F control is performed. (Pr.3, Pr.19)	Set rated frequency of the motor to Pr.3 Base frequency . Use Pr.19 Base frequency voltage to set the base voltage (e.g. rated motor voltage).	194
	The stall prevention function is activated due to a heavy load.	Set Pr.22 Stall prevention operation level higher according to the load. (If Pr.22 is set too high, an overcurrent trip (E.OC[]) is likely to occur.)	119
		Check the capacities of the inverter and the motor.	—
Auto tuning is not performed under General-purpose magnetic flux vector control.	Perform offline auto tuning	147	

6.6.10 Speed does not accelerate

Check point	Possible cause	Countermeasure	Refer to page
Input signal	The start command or frequency command is chattering.	Check if the start command and the frequency command are correct.	—
	The wiring length is too long for the analog frequency command, causing a voltage (current) drop.	Perform the bias and gain calibration for the analog input.	134
	The input signal lines are affected by external EMI.	Take countermeasures against EMI, such as using shielded wires for input signal lines.	50
Parameter setting	Pr.1 Maximum frequency, Pr.2 Minimum frequency, Pr.18 High speed maximum frequency, and calibration parameters C2 to C7 settings are not appropriate.	Check the settings of Pr.1 and Pr.2 . To operate at 120Hz or higher, set Pr.18 High speed maximum frequency .	117
		Check the calibration parameter C2 to C7 settings.	134
	The maximum voltage (current) input value is not set during the External operation. (Pr.125, Pr.126, Pr.18)	Check the Pr.125 Terminal 2 frequency setting gain frequency and Pr.126 Terminal 4 frequency setting gain frequency settings. To operate at 120 Hz or higher, set Pr.18 .	117, 134
	Torque boost (Pr.0) setting is improper under the V/F control, so the stall prevention function is activated.	Increase/decrease the Pr.0 Torque boost setting value by 0.5% increments so that stall prevention does not occur.	193
	The V/F pattern is not appropriate when V/F control is performed. (Pr.3, Pr.19)	Set rated frequency of the motor to Pr.3 Base frequency . Use Pr.19 Base frequency voltage to set the base voltage (e.g. rated motor voltage).	194
	The stall prevention function is activated due to a heavy load.	Reduce the load weight.	—
		Set Pr.22 Stall prevention operation level higher according to the load. (If Pr.22 is set too high, an overcurrent trip (E.OC[]) is likely to occur.)	119
		Check the capacities of the inverter and the motor.	—
Auto tuning is not performed under General-purpose magnetic flux vector control.	Perform offline auto tuning	147	
During PID control, the output frequency is automatically controlled so that the measured value equals the set point.		152	

6.6.11 Unable to write parameter setting

Check point	Possible cause	Countermeasure	Refer to page
Input signal	Operation is being performed (the STF or STR signal is ON).	Stop the operation. When Pr.77 Parameter write selection = "0 (initial value)", write is enabled only during a stop.	89
Parameter setting	Parameter setting was attempted in the External operation mode.	Choose the PU operation mode. Or, set Pr.77 Parameter write selection = "2" to enable parameter write regardless of the operation mode.	89, 100
	Parameter write is disabled by the Pr.77 Parameter write selection setting.	Check the Pr.77 setting.	89
	The key lock mode is enabled by the Pr.161 Frequency setting/key lock operation selection setting.	Check the Pr.161 setting.	88
	Operation mode and a writing device do not correspond.	Check Pr.79, Pr.338, Pr.339, and Pr.551 , and select an operation mode suitable for the purpose.	100, 105

CHAPTER 7 PRECAUTIONS FOR MAINTENANCE AND INSPECTION

7.1	Inspection item.....	228
7.2	Measurement of main circuit voltages, currents, and powers.....	232

7 PRECAUTIONS FOR MAINTENANCE AND INSPECTION

This chapter explains the precautions for maintenance and inspection of this product.
Always read the instructions before use.

7.1 Inspection item

The inverter is a static unit mainly consisting of semiconductor devices. Daily inspection must be performed to prevent any fault from occurring due to the adverse effects of the operating environment, such as temperature, humidity, dust, dirt and vibration, changes in the parts with time, service life, and other factors.

◆ Precautions for maintenance and inspection

When accessing the inverter for inspection, wait for at least 10 minutes after the power supply has been switched OFF. Then, make sure that the voltage across the main circuit terminals P/+ and N/- on the inverter is not more than 30 VDC using a tester, etc.

7.1.1 Daily inspection

Basically, check for the following faults during operation.

- Motor operation fault
- Improper installation environment
- Cooling system fault
- Abnormal vibration, abnormal noise
- Abnormal overheat, discoloration

7.1.2 Periodic inspection

Check the areas inaccessible during operation and requiring periodic inspection. Consult us for periodic inspection.

Check and clean the cooling system:
clean the air filter, etc.

Check the tightening and retighten: Tighten them according to the specified tightening torque. (Refer to [page 32](#).)
screws and bolts may become loose due to vibration, temperature changes, etc.

Check and tighten them.

Check the conductors and insulating materials for corrosion and damage.

Measure the insulation resistance.

Check and change the relay.

7.1.3 Daily and periodic inspection

Area of inspection	Inspection item	Description	Inspection interval		Corrective action at fault occurrence	Check by user
			Daily	Periodic ^{*3}		
General	Surrounding environment	Check the surrounding air temperature, humidity, dirt, corrosive gas, oil mist, etc.	○		Improve the environment.	
	Overall unit	Check for unusual vibration and noise.	○		Check fault location and retighten.	
		Check for dirt, oil, and other foreign material. ^{*1}	○		Clean.	
	Power supply voltage	Check that the main circuit voltage and control circuit voltage are normal. ^{*2}	○		Inspect the power supply.	

Area of inspection	Inspection item	Description	Inspection interval		Corrective action at fault occurrence	Check by user	
			Daily	Periodic ^{*3}			
Main circuit	General	<ul style="list-style-type: none"> • Check with megger (between main circuit terminals and earth (ground) terminal). • Check for loose screws and bolts. • Check for overheat traces on the parts. • Check for stains. 		○	Contact the manufacturer. Retighten. Contact the manufacturer. Clean.		
	Conductors and cables	<ul style="list-style-type: none"> • Check conductors for distortion. • Check cable sheaths for breakage and deterioration (crack, discoloration, etc.). 		○	Contact the manufacturer. Contact the manufacturer.		
	Transformer/reactor	Check for unusual odor and abnormal increase of whining sound.	○		Stop the equipment and contact the manufacturer.		
	Terminal block	Check for a damage.		○	Stop the equipment and contact the manufacturer.		
	Smoothing aluminum electrolytic capacitor	<ul style="list-style-type: none"> • Check for liquid leakage. • Check for safety valve projection and bulge. 		○	Contact the manufacturer. Contact the manufacturer.		
	Relay/contactor	Check that the operation is normal and no chattering sound is heard.		○	Contact the manufacturer.		
	Resistor	<ul style="list-style-type: none"> • Check for cracks in the resistor insulator. • Check for a break in the cable. 		○	Contact the manufacturer. Contact the manufacturer.		
Control circuit Protective circuit	Operation check	<ul style="list-style-type: none"> • Check for an output voltage imbalance between phases while operating the inverter alone. • Check that no fault is found in protective and display circuits in a sequence protective operation test. 		○	Contact the manufacturer. Contact the manufacturer.		
	Components check	Overall	<ul style="list-style-type: none"> • Check for unusual odor and discoloration. • Check for serious rust development. 		○	Stop the equipment and contact the manufacturer. Contact the manufacturer.	
		Aluminum electrolytic capacitor	• Check for liquid leakage in a capacitor and deformation trace.		○	Contact the manufacturer.	
Cooling system	Cooling fan	• Check for stains.		○	Clean.		
	Heatsink	<ul style="list-style-type: none"> • Check for clogging. • Check for stains. 		○	Clean. Clean.		
Display	Display	<ul style="list-style-type: none"> • Check that display is normal. • Check for stains. 	○		Contact the manufacturer. Clean.		
	Meter	Check that reading is normal.	○		Stop the equipment and contact the manufacturer.		
Load Motor	Operation check	Check for vibration and abnormal increase in operation noise.	○		Stop the equipment and contact the manufacturer.		

*1 Oil component of the heat dissipation grease used inside the inverter may leak out. The oil component, however, is not flammable, corrosive, nor conductive and is not harmful to humans. Wipe off such oil component.

*2 It is recommended to install a voltage monitoring device to check the voltage of the power supplied to the inverter.

*3 One to two years of periodic inspection cycle is recommended. However, it differs according to the installation environment. Consult us for periodic inspection.

NOTE

- Continuous use of a leaked, deformed, or degraded smoothing aluminum electrolytic capacitor (as shown in the table above) may lead to a burst, breakage, or fire. Replace such capacitor without delay.

7.1.4 Checking the inverter and converter modules

◆ Preparation

- Disconnect the external power supply cables (R/L1, S/L2, T/L3) and motor cables (U, V, W).
- Prepare a continuity tester. (For the resistance measurement, use the 100 Ω range.)

◆ Checking method

Change the polarity of the tester alternately at the inverter terminals R/L1, S/L2, T/L3, U, V, W, P/+, and N/- to check the electric continuity.

NOTE

- Before measurement, check that the smoothing capacitor is discharged.
- At the time of electric discontinuity, the measured value is almost ∞ . When there is an instantaneous electric continuity, due to the smoothing capacitor, the tester may not indicate ∞ . At the time of electric continuity, the measured value is several Ω to several tens of Ω . If all measured values are almost the same, although these values are not constant depending on the module type and tester type, the modules are without fault.

◆ Module device numbers and terminals to be checked

		Tester polarity		Continuity			Tester polarity		Continuity
		⊕	⊖				⊕	⊖	
Converter module	D1	R/L1	P/+	No	D4	R/L1	N/-	Yes	
		P/+	R/L1	Yes		N/-	R/L1	No	
	D2	S/L2	P/+	No	D5	S/L2	N/-	Yes	
		P/+	S/L2	Yes		N/-	S/L2	No	
	D3	T/L3	P/+	No	D6	T/L3	N/-	Yes	
		P/+	T/L3	Yes		N/-	T/L3	No	
Inverter module	TR1	U	P/+	No	TR4	U	N/-	Yes	
		P/+	U	Yes		N/-	U	No	
	TR3	V	P/+	No	TR6	V	N/-	Yes	
		P/+	V	Yes		N/-	V	No	
	TR5	W	P/+	No	TR2	W	N/-	Yes	
		P/+	W	Yes		N/-	W	No	

(Assuming that an analog tester is used.)

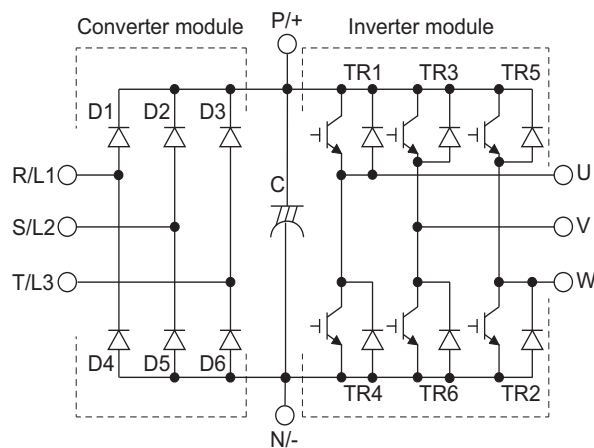

7.1.5 Cleaning

Always run the inverter in a clean state.

When cleaning the inverter, gently wipe dirty areas with a soft cloth immersed in neutral detergent or ethanol.

NOTE

- Do not use solvent, such as acetone, benzene, toluene and alcohol, as these will cause the inverter surface paint to peel off.
- As the display of the PU, etc. is vulnerable to detergent and alcohol, avoid using them for cleaning.

7.1.6 Lifespan

The inverter consists of many electronic parts such as semiconductor devices.

The following parts may deteriorate with age because of their structures or physical characteristics, leading to reduced performance or fault of the inverter.

Part name	Estimated lifespan ^{*1}
Cooling fan	5 years.
Main circuit smoothing capacitor	5 years. ^{*2}
On-board smoothing capacitor	5 years. ^{*2}
Relays	—

*1 Estimated lifespan when the yearly average surrounding air temperature is 40°C (without corrosive gas, flammable gas, oil mist, dust or dirt etc.).

*2 Output current: 80% of the inverter rating

NOTE

- For parts replacement, contact the nearest Mitsubishi Electric FA center.

◆ Smoothing capacitors

A large-capacity aluminum electrolytic capacitor is used for smoothing in the main circuit DC section, and an aluminum electrolytic capacitor is used for stabilizing the control power in the control circuit. Their characteristics are deteriorated by the adverse effects of ripple currents, etc. The replacement intervals greatly vary with the surrounding air temperature and operating conditions.

The appearance criteria for inspection are as follows.

- Case: Check the side and bottom faces for expansion.
- Sealing plate: Check for a remarkable warp and extreme crack.
- Others: Check for external crack, discoloration, and liquid leakage.

7.2 Measurement of main circuit voltages, currents, and powers

Since the voltages and currents on the inverter power supply and output sides include harmonics, measurement data depends on the instruments used and circuits measured. When instruments for commercial frequency are used for measurement, measure the following circuits with the instruments given on the next page.

NOTE

- When installing meters etc. on the inverter output side
When the inverter-to-motor wiring length is long, especially in the 400 V class, small-capacity models, the meters and CTs may generate heat due to line-to-line leakage current. Therefore, choose the equipment which has enough allowance for the current rating.

◆ Examples of measuring points and instruments

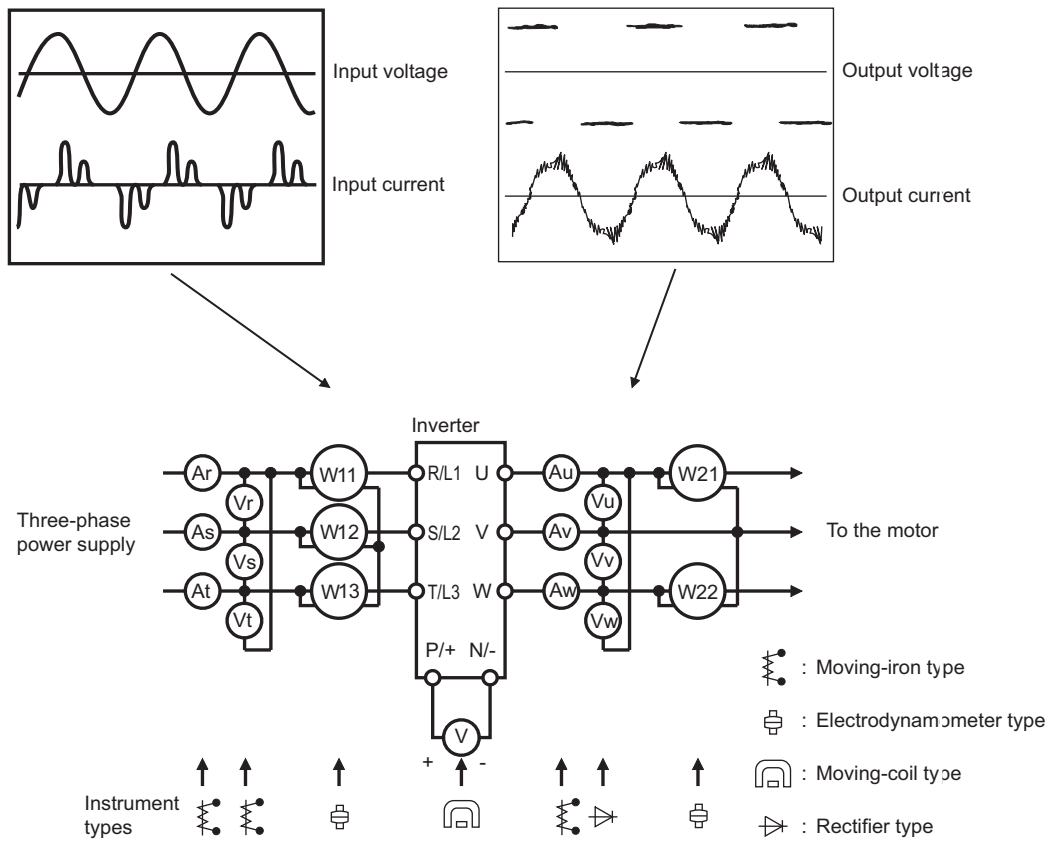

◆ Measuring points and instruments

Item	Measuring point	Measuring instrument	Remarks (reference measured value)							
Power supply voltage V1	Between R/L1 and S/L2, S/L2 and T/L3, or T/L3 and R/L1	Moving-iron type AC voltmeter ^{*4}	Commercial power supply. Within permissible AC voltage fluctuation. (Refer to page 238.)							
Input current I1	R/L1, S/L2, T/L3 line current	Moving-iron type AC ammeter ^{*4}								
Input power P1	R/L1, S/L2, T/L3, and between R/L1 and S/L2, S/L2 and T/L3, or T/L3 and R/L1	Digital power meter (designed for inverter) or electrodynamic type single-phase wattmeter	P1 = W11 + W12 + W13 (3-wattmeter method)							
Input power factor Pf1	Calculate after measuring input voltage, input current, and input power. $Pf_1 = \frac{P_1}{\sqrt{3}V_1 \times I_1} \times 100\%$									
Output voltage V2	Between U and V, V and W, or W and U	Rectifier type AC voltage meter ^{*1*4} (moving-iron type cannot measure.)	Difference between the phases is within 1% of the maximum output voltage.							
Output current I2	U, V and W line currents	Moving-iron type AC ammeter ^{*2*4}	Difference between the phases is 10% or lower of the rated inverter current.							
Output power P2	U, V, or W, and between U and V, or V and W	Digital power meter (designed for inverter) or electrodynamic type single-phase wattmeter	P2 = W21 + W22 2-wattmeter method (or 3-wattmeter method)							
Output power factor Pf2	Calculate in a similar manner to the input power factor. $Pf_2 = \frac{P_2}{\sqrt{3}V_2 \times I_2} \times 100\%$									
Converter output	Between P/+ and N/-	Moving-coil type (such as tester)	Inverter LED indication 1.35 × V1							
Frequency setting signal	2, and between 4(+) and 5	Moving-coil type (such as tester) (internal resistance 50 kΩ or more)	0 to 10 VDC, 4 to 20 mA							
Power supply for a frequency setting potentiometer	Between 10(+) and 5		5.2 VDC							
Frequency meter signal	Between AM(+) and 5		Approximately 10 VDC at maximum frequency (without frequency meter).							
Start signal Select signal Reset signal Output stop signal	Between STF, STR, RH, RM, or RL, and SD (for sink logic)		When open 20 to 30 VDC ON voltage: 1 V or less							
Fault signal	Between A and C	Moving-coil type (such as tester)	Continuity check ^{*3}							
	Between B and C		<table border="0"> <tr> <td></td> <td>[Normal]</td> <td>[Fault]</td> </tr> <tr> <td>A - C</td> <td>No</td> <td>Yes</td> </tr> <tr> <td>B - C</td> <td>Yes</td> <td>No</td> </tr> </table>		[Normal]	[Fault]	A - C	No	Yes	B - C
	[Normal]	[Fault]								
A - C	No	Yes								
B - C	Yes	No								

*1 Use an FFT to measure the output voltage accurately. A tester or general measuring instrument cannot measure accurately.

*2 When the carrier frequency exceeds 5 kHz, do not use this instrument since using it may increase eddy current losses produced in metal parts inside the instrument, leading to burnout. In this case, use an approximate-effective value type.

*3 When the setting of **Pr.195 ABC terminal function selection** is the positive logic

*4 A digital power meter (designed for inverter) can also be used to measure.

7.2.1 Measurement of powers

Use digital power meters (for inverter) both on the inverter's input and output sides. Alternatively, use electrodynamic type single-phase wattmeters both on the inverter's input and output sides in the two-wattmeter or three-wattmeter method. As the current is liable to be imbalanced especially on the input side, it is recommended to use the three-wattmeter method.

Examples of measured value differences produced by different measuring meters are shown in the following figure.

An error will be produced by difference between measuring instruments, e.g. power calculation type and two- or three-wattmeter type three-phase wattmeter. When a CT is used in the current measuring side or when the meter contains a PT on the voltage measurement side, an error will also be produced due to the frequency characteristics of the CT and PT.

[Measurement conditions]

Constant output of 60 Hz or more frequency with a constant-torque (100%). The value obtained by the 3-wattmeter method with a 4-pole 3.7 kW induction motor is assumed to be 100%.

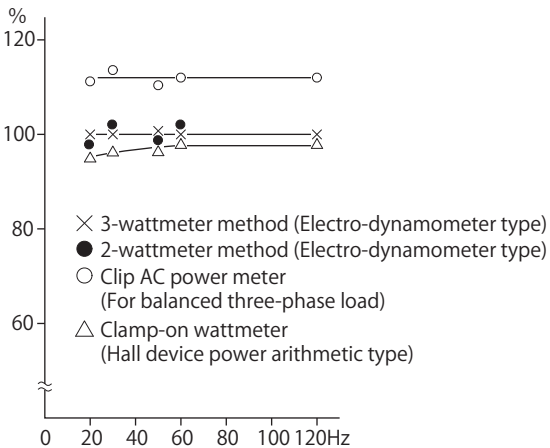

Example of measuring inverter input power

[Measurement conditions]

Constant output of 60 Hz or more frequency with a constant-torque (100%). The value obtained by the 3-wattmeter method with a 4-pole 3.7 kW induction motor is assumed to be 100%.

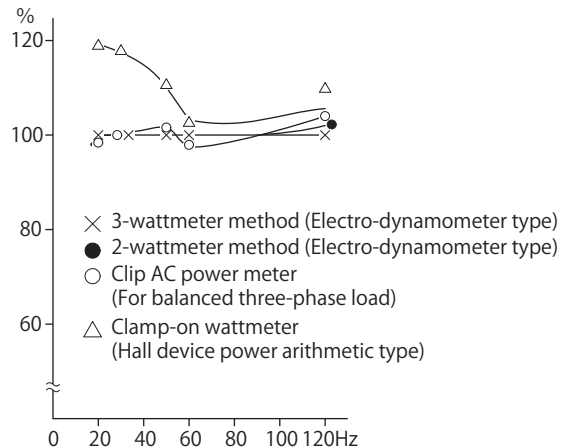

Example of measuring inverter output power

7.2.2 Measurement of voltages and use of PT

◆ Inverter input side

As the input voltage has a sine wave and it is extremely small in distortion, accurate measurement can be made with an ordinary AC meter.

◆ Inverter output side

Since the output voltage has a PWM-controlled rectangular wave, always use a rectifier type voltmeter. A needle type tester cannot be used to measure the output voltage as it indicates a value much greater than the actual value. A moving-iron type meter indicates an effective value which includes harmonics and therefore the value is larger than that of the fundamental wave. The value displayed on the operation panel is the inverter-controlled voltage itself. Hence, that value is accurate and it is recommended to monitor values using the operation panel.

◆ PT

No PT can be used on the output side of the inverter. Use a direct-reading meter. (A PT can be used on the input side of the inverter.)

7.2.3 Measurement of currents

Use moving-iron type meters both on the inverter's input and output sides. However, if the carrier frequency exceeds 5 kHz, do not use that meter since an overcurrent losses produced in the internal metal parts of the meter will increase and the meter may burn out. In this case, use an approximate-effective value type.

Since the inverter input current tends to be unbalanced, measurement of three phases is recommended. The correct value cannot be obtained by measuring only one or two phases. On the other hand, the unbalanced ratio of each phase of the output current should be within 10%.

When a clamp ammeter is used, always use an effective value detection type. A mean value detection type produces a large error and may indicate an extremely smaller value than the actual value. The value displayed on the operation panel is accurate even if the output frequency varies. Hence, it is recommended to monitor values using the operation panel.

Examples of measured value differences produced by different measuring meters are as follows:

[Measurement conditions]

The value indicated on the moving-iron type ammeter is 100%.

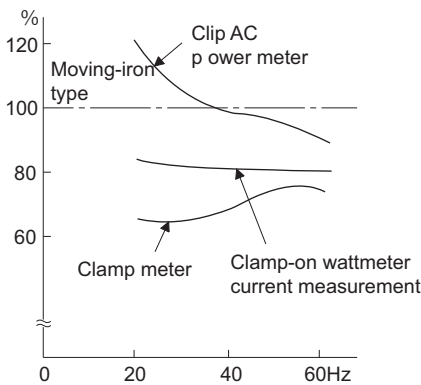

Example of measuring the inverter input current

[Measurement conditions]

The value indicated on the moving-iron type ammeter is 100%.

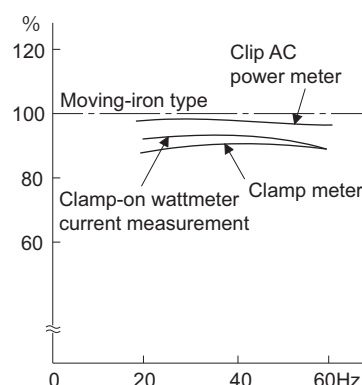

Example of measuring the inverter output current

7.2.4 Use of CT and transducer

A CT may be used both on the inverter's input and output sides. Use the one with the largest possible VA ability because an error will increase if the frequency gets lower.

When using a transducer, use the effective value calculation type which is immune to harmonics.

7.2.5 Measurement of inverter input power factor

Calculate the factor from the effective power and the apparent power. A power-factor meter cannot indicate an exact value.

$$\begin{aligned} \text{Total power factor of the inverter} &= \frac{\text{Effective power}}{\text{Apparent power}} \\ &= \frac{\text{Three-phase input power found by the 3-wattmeter method}}{\sqrt{3} \times V (\text{power supply voltage}) \times I (\text{input current effective value})} \end{aligned}$$

7.2.6 Measurement of converter output voltage (between terminals P and N)

The output voltage of the converter can be measured with a moving-coil type meter (tester) between terminals P and N. The voltage varies according to the power supply voltage. Approximately 270 to 300 V (540 to 600 V for the 400 V class) is output when no load is connected. The voltage decreases when a load is applied.

When energy is regenerated from the motor during deceleration, for example, the converter output voltage rises to nearly 400 to 450 VDC (800 to 900 VDC for the 400 V class) maximum.

7.2.7 Insulation resistance test using megger

- For the inverter, conduct the insulation resistance test on the main circuit only as follows and do not perform the test on the control circuit.

(Use a 500 VDC megger.)

NOTE

- Before performing the insulation resistance test on the external circuit, disconnect the cables from all terminals of the inverter so that the test voltage is not applied to the inverter.
- For the continuity test of the control circuit, use a tester (high resistance range) and do not use the megger or buzzer.

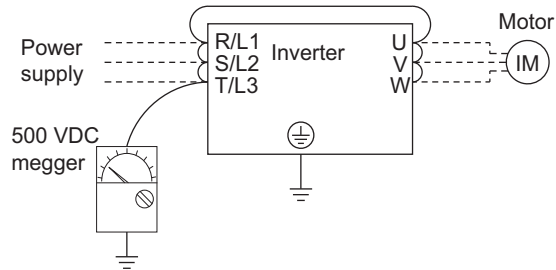

7.2.8 Pressure test

Do not conduct a pressure test. Deterioration may occur.

CHAPTER 8 SPECIFICATIONS

8.1	Inverter rating.....	238
8.2	Common specifications.....	239
8.3	Outline dimension drawings.....	241

8 SPECIFICATIONS

This chapter explains the specifications of this product.

Always read the instructions before use.

8.1 Inverter rating

◆ Three-phase 400 V class

Model FR-CS84-□	012	022	036	050	080	120	160	230	295	
Applicable motor capacity (kW) ^{*1}	0.4	0.75	1.5	2.2	3.7	5.5	7.5	11	15	
Output	Rated capacity (kVA) ^{*2}	0.9	1.7	2.7	3.8	6.1	9.1	12.2	22.5	
	Rated current (A) ^{*3}	1.2 (1.0)	2.2 (1.9)	3.6 (3.1)	5.0 (4.3)	8.0 (6.8)	12.0 (10.2)	16.0 (13.6)	23.0 (19.6)	29.5 (25.1)
	Overload current rating ^{*4}	150% 60 s, 200% 0.5 s (inverse-time characteristics).								
	Rated voltage ^{*5}	Three-phase 380 to 480 V.								
Power supply	Rated input AC voltage/frequency	Three-phase 380 to 480 V, 50/60 Hz.								
	Permissible AC voltage fluctuation	325 to 528 V, 50/60 Hz.								
	Permissible frequency fluctuation	±5%								
	Power supply capacity (kVA) ^{*6}	1.5	2.5	4.5	5.5	9.5	12.0	17.0	20.0	28.0
Protective structure (IEC 60529)	Open type (IP20).									
Cooling system	Natural.					Forced air.				
Approx. mass (kg)	0.6	0.6	0.9	0.9	1.4	1.9	1.9	3.5	3.5	

*1 The applicable motor capacity indicated is the maximum capacity applicable for use of the Mitsubishi Electric 4-pole standard motor.

*2 The rated output capacity assumes that the output voltage is 440 V.

*3 When using the inverter at the surrounding air temperature of 50°C, the rated current is decreased to the value shown in the parentheses.

*4 The percentage of the overload current rating is the ratio of the overload current to the inverter's rated output current. For repeated duty, allow time for the inverter and motor to return to or fall below the temperatures under 100% load.

*5 The maximum output voltage does not exceed the power supply voltage. The maximum output voltage can be changed within the setting range.

However, the maximum point of the voltage waveform at the inverter output side is the power supply voltage multiplied by about $\sqrt{2}$.

*6 The power supply capacity is the value at the rated output current. The input power impedances (including those of the input reactor and cables) affect the value.

◆ Single-phase 200V class

Model FR-CS82S-□	025	042	070	100	
Applicable motor capacity (kW) ^{*1}	0.4	0.75	1.5	2.2	
Output	Rated capacity (kVA) ^{*2}	1.0	1.7	2.8	4.0
	Rated current (A) ^{*3}	2.5 (2.1)	4.2 (3.6)	7.0 (6.0)	10.0 (8.5)
	Overload current rating ^{*4}	150% 60 s, 200% 0.5 s (inverse-time characteristics).			
	Rated voltage ^{*5}	Three-phase 200 to 240 V.			
Power supply	Rated input AC voltage/frequency	Single-phase 200 to 240 V, 50/60 Hz.			
	Permissible AC voltage fluctuation	170 to 264 V, 50/60 Hz.			
	Permissible frequency fluctuation	±5%			
	Power supply capacity (kVA) ^{*6}	1.5	2.3	4.0	5.2
Protective structure (IEC 60529)	Open type (IP20).				
Cooling system	Natural.			Forced air.	
Approx. mass (kg)	0.6	0.6	1.4	1.4	

*1 The applicable motor capacity indicated is the maximum capacity applicable for use of the Mitsubishi Electric 4-pole standard motor.

*2 The rated output capacity assumes that the output voltage is 230 V.

*3 When using the inverter at the surrounding air temperature of 50°C, the rated current is decreased to the value shown in the parentheses.

*4 The percentage of the overload current rating is the ratio of the overload current to the inverter's rated output current. For repeated duty, allow time for the inverter and motor to return to or below the temperatures under 100% load. If the automatic restart after instantaneous power failure function (Pr. 57) or power failure stop function (Pr. 261) is set and power supply voltage is low while load becomes bigger, the bus voltage decreases to power failure detection level and load of 100% or more may not be available.

*5 The maximum output voltage does not exceed the power supply voltage. The maximum output voltage can be changed within the setting range.

However, the maximum point of the voltage waveform at the inverter output side is the power supply voltage multiplied by about $\sqrt{2}$.

*6 The power supply capacity is the value at the rated output current. The input power impedances (including those of the input reactor and cables) affect the value.

8.2 Common specifications

Control	Control method		Soft-PWM control, high carrier frequency PWM control (selectable among V/F control, General-purpose magnetic flux vector control, Optimum excitation control).
	Output frequency range		0.2 to 400 Hz.
	Frequency setting and resolution	Analog input	0.06/60 Hz at 0 to 10 V / 10 bits (terminals 2 and 4). 0.12/60 Hz at 0 to 5 V / 9 bits (terminals 2 and 4). 0.06/60 Hz at 0 to 20 mA / 10 bits (terminal 4).
		Digital input	0.01 Hz.
	Frequency accuracy	Analog input	Within $\pm 1\%$ of the maximum output frequency at 25°C ($\pm 10^\circ\text{C}$).
		Digital input	0.01% or less of the set output frequency.
	Voltage/frequency characteristics		Base frequency can be set from 0 to 400 Hz. Constant-torque or adjustable 3 points V/F can be selected.
	Starting torque		150% or more at 1 Hz, with General-purpose magnetic flux vector control and slip compensation.
	Torque boost		Manual torque boost.
	Acceleration/deceleration time setting		0.1 to 3600 s (acceleration and deceleration can be set individually), linear or S-pattern acceleration/ deceleration modes are available.
	DC injection brake		Operation frequency (0 to 120 Hz), operation time (0 to 10 s), operation voltage (0 to 30%) variable.
Stall prevention operation level		Operation current: 0 to 200% variable, with selectable availability of the function.	
Operation	Frequency setting signal	Analog input (2)	Terminal 2: 0 to 10 V / 0 to 5 V. Terminal 4: 0 to 10 V / 0 to 5 V / 4 to 20 mA.
		Digital input	Input from the PU, with selectable frequency setting increments.
	Start signal		Forward and reverse rotation or start signal automatic self-holding input (3-wire input) can be selected.
	Input signal (5)		Using Pr.178 to Pr.182 (input terminal function selection) , the signal can be selected from the following: Multi-speed selection, Remote setting, Second acceleration/deceleration function selection, Terminal 4 input selection, JOG operation selection, PID control valid terminal, External thermal relay input, Output stop, Start self-holding selection, Forward rotation command, Reverse rotation command, Inverter reset, Traverse function selection.
	Operational function		Maximum frequency, minimum frequency, frequency jump operation, external thermal relay input selection, automatic restart after instantaneous power failure operation, forward/reverse rotation prevention, remote setting, second acceleration/deceleration function, multi-speed operation, regeneration avoidance, slip compensation, operation mode selection, offline auto tuning, PID control, computer link operation (RS-485 communication), Optimum excitation control, power failure stop, MODBUS RTU, increased magnetic excitation deceleration.
	Output signal relay output (1)		Using Pr.195 output terminal function selection , the signal can be selected from the following: Inverter running, Up to frequency, Overload warning, Output frequency detection, Electronic thermal O/L relay pre-alarm, Inverter operation ready, Output current detection, PID lower limit, PID upper limit, PID forward/reverse rotation output, Heatsink overheat pre-alarm, During deceleration at occurrence of power failure, During PID control activated, PID output interruption, During retry, Alarm output, Fault output, Fault output 3.
	Indication	Operation panel	Status monitoring
Fault record			Fault record is displayed when a protective function is activated. Past 8 fault records are stored. (output voltage, output current, frequency, and cumulative energization time right before the protective function is activated.)
Parameter unit (FR-PU07)		Interactive guidance	Help function for operation guide ^{*1} .

Protective function		Fault	Overvoltage during acceleration, Overvoltage during constant speed, Overvoltage during deceleration, Inverter overload trip (electronic thermal relay function), Motor overload trip (electronic thermal relay function), Heatsink overheat, Input phase loss ^{*3} , Output side earth (ground) fault overcurrent as start, Output short circuit, Output phase loss, External thermal relay operation ^{*2} , Parameter error, PU disconnection ^{*2} , Retry count excess ^{*2} , CPU fault, Inrush current limit circuit fault, 4 mA input fault ^{*2} , Stall prevention stop, Output current detection value exceeded ^{*2} , Inverter output fault ^{*5} , Undervoltage.
		Alarm, Warning, Error message	Overcurrent stall prevention, Overvoltage stall prevention, PU stop, Parameter write error, Electronic thermal O/L relay pre-alarm, Undervoltage, Inrush current limit resistor heating, Operation panel lock, Password locked, Inverter reset.
Environment	Surrounding air temperature	-10 to +40°C (non-freezing) ^{*4} , 40 to +50°C (non-freezing) at the rated current reduced by 15%.	
	Surrounding air humidity	95% RH or less (non-condensing) for models with circuit board coating.	
	Storage temperature^{*6}	-20 to +65°C	
	Ambience	Indoors (free from corrosive gas, flammable gas, oil mist, dust or dirt).	
	Altitude/vibration	2500 m or less (For the installation at an altitude above 1000 m, consider a 3% reduction in the rated current per 500 m increase in altitude.), 5.9 m/s ² or less at 10 to 55 Hz (directions of X, Y, Z axes)	

*1 Available for the option parameter unit (FR-PU07) only.

*2 This protective function is not available in the initial status.

*3 Available for the three-phase power input models.

*4 When using the inverters at the surrounding air temperature of 40°C or less, the inverters can be installed closely attached (0 cm clearance).

*5 Available for the FR-CS84-160 or lower or the FR-CS82S.

*6 Applicable to conditions for a short time, for example, in transit.

8.3 Outline dimension drawings

8.3.1 Inverter outline dimension drawings

FR-CS84-012, FR-CS84-022

FR-CS82S-025, 042

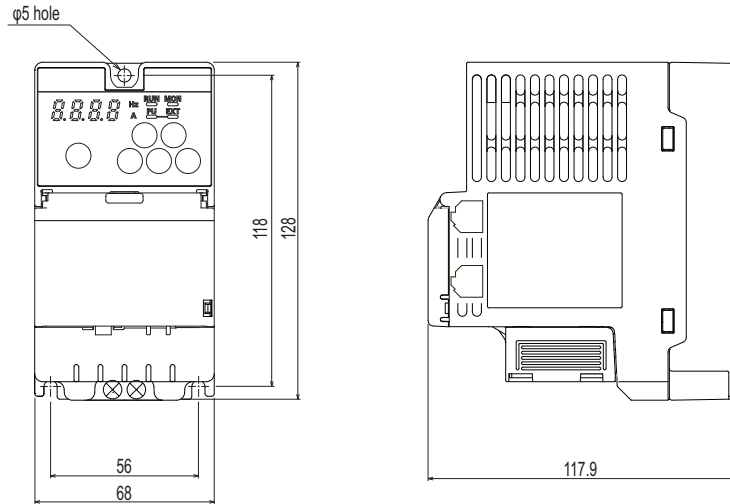

(Unit: mm)

FR-CS84-036, 050, 080-60

FR-CS82S-070, 100

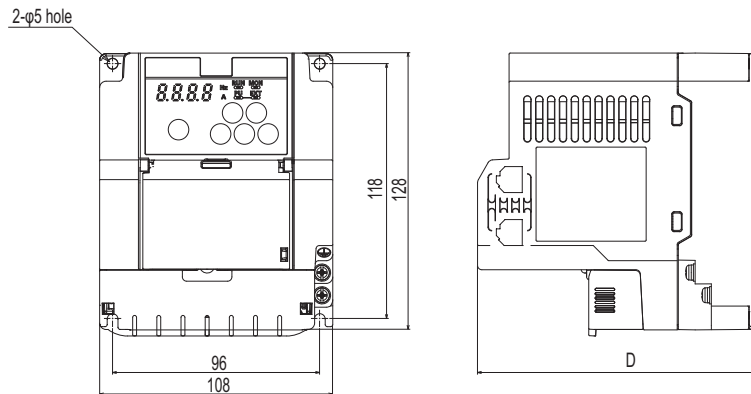

Model	D
FR-CS84-036, 050	130
FR-CS84-080 FR-CS82S-070, 100	160

(Unit: mm)

FR-CS84-120, 160

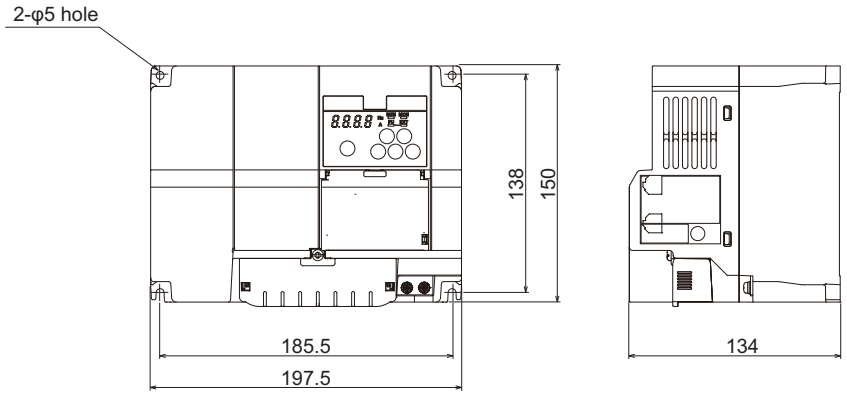

(Unit: mm)

FR-CS84-230, 295

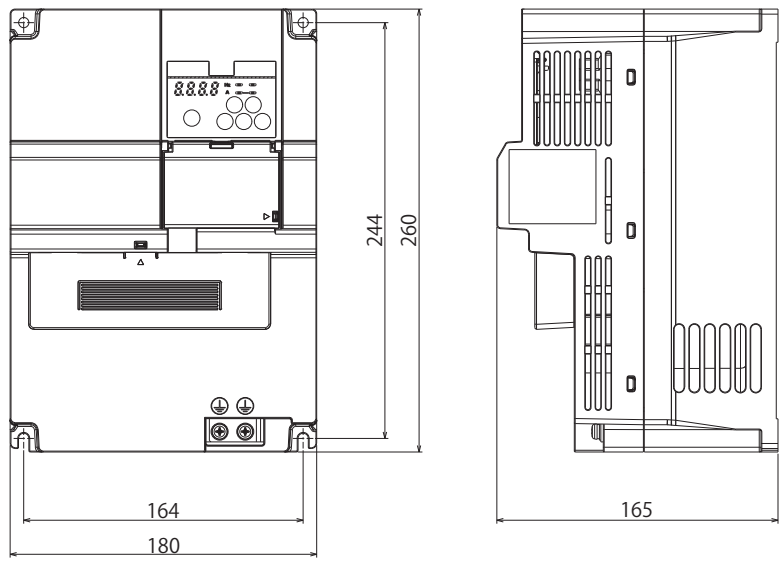

(Unit: mm)

MEMO

mitsubishi electric corporation
HEAD OFFICE: TOKYO BUILDING 2-7-3, MARUNOUCHI, CHIYODA-KU, TOKYO 100-8310, JAPAN