

Machine Automation Controller NJ-series

# DeviceNet™ Connection Guide

## OMRON Corporation

3G3MX2-series Inverter

Network  
Connection  
Guide

### **About Intellectual Property Right and Trademarks**

---

Windows is a registered trademark of Microsoft Corporation in the USA and other countries.

DeviceNet™ is a trademark of ODVA.

EtherCAT® is registered trademark and patented technology, licensed by Beckhoff Automation GmbH, Germany.

Company names and product names in this document are the trademarks or registered trademarks of their respective companies.

---

## Table of Contents

<b>1. Related Manuals</b> .....	<b>1</b>
<b>2. Terms and Definition</b> .....	<b>1</b>
<b>3. Remarks</b> .....	<b>2</b>
<b>4. Overview</b> .....	<b>4</b>
<b>5. Applicable Devices and Support Software</b> .....	<b>4</b>
5.1. Applicable Devices.....	4
5.2. Device Configuration.....	6
<b>6. DeviceNet Settings</b> .....	<b>8</b>
6.1. DeviceNet Communications Settings.....	8
6.2. Allocation of Remote I/O Communications.....	8
<b>7. Connection Procedure</b> .....	<b>11</b>
7.1. Overview of Setting Up Remote I/O Communications.....	11
7.2. Work Flow.....	12
7.3. Setting Up the Inverter.....	13
7.4. Setting Up the Controller.....	21
7.5. Setting Up the Network.....	28
7.6. Connection Status Check.....	33
<b>8. Initialization Method</b> .....	<b>38</b>
8.1. Controller.....	38
8.2. Inverter.....	39
<b>9. Appendix 1 Details of Remote I/O Communication Settings</b> .....	<b>40</b>
9.1. Global Variable Table .....	40
<b>10. Appendix 2 Setting Procedure without the Configuration Files</b> .....	<b>41</b>
10.1. Overview of Setting Procedure without the Configuration Files .....	41
10.2. Work Flow of the "Procedure for Setting the Parameters from the Beginning" ..	42
10.3. Setting up the Controller without the Configuration Files .....	44
10.4. Setting up the Network by CX-Integrator.....	54
<b>11. Revision History</b> .....	<b>62</b>

## 1. Related Manuals

The table below lists the manuals related to this document.

To ensure system safety, make sure to always read and heed the information provided in all Safety Precautions, Precautions for Safe Use, and Precaution for Correct Use of manuals for each device which is used in the system.

Cat.No.	Model	Manual name
W500	NJ501-□□□□	NJ-series CPU Unit Hardware User's Manual
W501	NJ501-□□□□	NJ-series CPU Unit Software User's Manual
W497	CJ1W-DRM21	CJ-series DeviceNet™ Units Operation Manual for NJ-series CPU Unit
W267	-	DeviceNet™ Operation Manual
W504	SYSMAC-SE2□□□□	Sysmac Studio Version 1 Operation Manual
W464	-	CX-Integrator CS/CJ/CP/NSJ-series Network Configuration Tool Operation Manual
I570	3G3MX2-A□□□□□	SYSDRIVE MX2 Series Multi-function Compact Inverter User's Manual
I581	3G3AX-MX2-DRT-E	MX2/RS Series DeviceNet™ Communications Unit User's Manual

## 2. Terms and Definition

Terms	Explanation and Definition
Master/slave	<p>A master is a unit that manages the DeviceNet communications.</p> <p>A master sends output data to multiple slaves and receives input data from the slaves.</p> <p>Slaves receive output data that are sent from the master, and send input data to the master.</p> <p>At least one master is required for DeviceNet communications.</p>
EDS file	A file that contains each DeviceNet slave's I/O points and parameters that can be set via DeviceNet.
Node address (MAC ID)	<p>An address that identifies a unit connected to a DeviceNet network.</p> <p>With DeviceNet, a MAC (Media Access Control) ID is used as a node address. Thus, a node address is a MAC ID.</p>
Scan list	A scan list is used to register slaves with which a master communicates in DeviceNet remote I/O communications. A master communicates with the slaves based on the scan list settings.

### 3. Remarks

- (1) Understand the specifications of devices which are used in the system. Allow some margin for ratings and performance. Provide safety measures, such as installing safety circuit in order to ensure safety and minimize risks for abnormal occurrence.
- (2) To ensure system safety, always read and heed the information provided in all Safety Precautions, Precautions for Safe Use, and Precaution for Correct Use of manuals for each device used in the system.
- (3) The users are encouraged to confirm the standards and regulations that the system must conform to.
- (4) It is prohibited to copy, to reproduce, and to distribute a part of or whole part of this document without the permission of OMRON Corporation.
- (5) This document provides the latest information as of February 2012. The information contained in this document is subject to change for improvement without notice.

The following notation is used in this document.



### WARNING

Indicates a potentially hazardous situation which, if not avoided, could result in death or serious injury. Additionally, there may be severe property damage.



### Caution

Indicates a potentially hazardous situation which, if not avoided, may result in minor or moderate injury, or property damage.



### Precautions for Safe Use

Indicates precautions on what to do and what not to do to ensure using the product safely.



### Precautions for Correct Use

Indicates precautions on what to do and what not to do to ensure proper operation and performance.



### Additional Information

Provides useful information.

Additional information to increase understanding or make operation easier.

## Symbols



The circle and slash symbol indicates operations that you must not do. The specific operation is shown in the circle and explained in text. This example indicates prohibiting disassembly.



The triangle symbol indicates precautions (including warnings). The specific operation is shown in the triangle and explained in text. This example indicates a precaution for electric shock.



The triangle symbol indicates precautions (including warnings). The specific operation is shown in the triangle and explained in text. This example indicates a general precaution.



The filled circle symbol indicates operations that you must do. The specific operation is shown in the circle and explained in text. This example shows a general precaution for something that you must do.

## 4. Overview

This document describes the procedure for connecting the OMRON Inverter (3G3MX2 series) to the OMRON Machine Automation NJ-series Controller (hereinafter referred to as Controller) on the DeviceNet and provides the procedure for checking their connection.

This document describes the procedure for establishing a DeviceNet connection using DeviceNet settings of the project files prepared in advance (hereinafter referred to as the "procedures for using configuration files").

Sections 9 A-1 and 10 A-2 describe the procedures for setting parameters without the prepared configuration files (hereinafter referred to as the "procedures for setting parameters from beginning").

To follow the "procedures for using configuration files", obtain the latest "Sysmac Studio project file" and "CX-Integrator project file" (they are referred to as "configuration files") from OMRON in advance.

Name	File name	Version
Sysmac Studio project file (extension: SMC)	OMRON_3G3MX2_DN_EV100.SMC	Ver.1.00
CX-Integrator project file (extension: cin)	OMRON_3G3MX2_DN_EV100.cin	Ver.1.00

## 5. Applicable Devices and Support Software

### 5.1. Applicable Devices

The following devices can be connected.

Manufacturer	Name	Model	Version
OMRON	NJ-series CPU Unit	NJ501-□□□□	Versions listed in Section 5.2 and higher versions
OMRON	DeviceNet Unit (Master Unit)	CJ1W-DRM21	
OMRON	Inverter	3G3MX2-A□□□□	
OMRON	DeviceNet Communications Unit	3G3AX-MX2-DRT-E	



#### Additional Information

As applicable devices above, the devices listed in Section 5.2. are actually used in this document to check the connection. When using devices not listed in Section 5.2, check the connection by referring to the procedure in this document.



### **Additional Information**

---

This document describes the procedure to establish the network connection. It does not provide information about operation, installation nor wiring method of each device.

For details on above products (other than communication connection procedures), refer to the manuals for the corresponding products or contact your OMRON representative.

---



### **Additional Information**

---

You can connect devices with the versions listed in Section 5.2 or higher versions.

For devices whose versions are not listed in Section 5.2, versions are not managed or there is no version restriction.

To connect a device whose model number is not listed in Section 5.2, use the same version of the device that is listed.

---



## 5.2. Device Configuration

The hardware components to reproduce the connection procedure of this document are as follows.

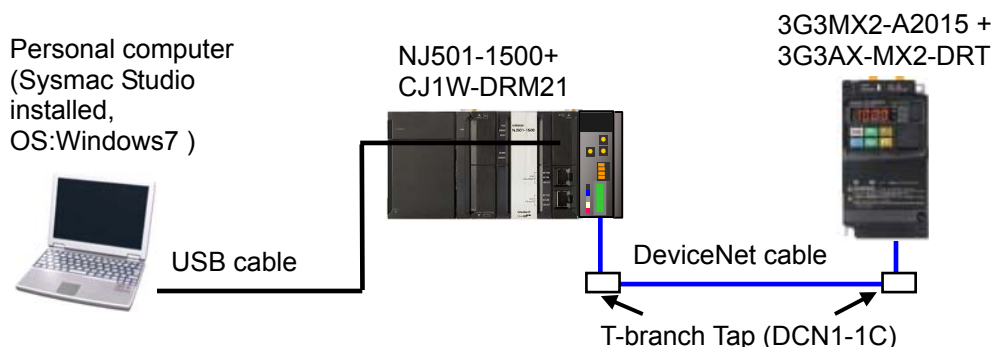

Manufacturer	Name	Model	Version
OMRON	DeviceNet Unit (Master Unit)	CJ1W-DRM21	Ver.1.3
OMRON	CPU Unit	NJ501-1500	
OMRON	Power Supply Unit	NJ-PA3001	
OMRON	DeviceNet cable	DCA1-5C10	
OMRON	T-branch Tap	DCN1-1C	
OMRON	Sysmac Studio	SYSMAC-SE2[ ] [ ] [ ] [ ]	Ver.1.00
OMRON	CX-Integrator	(Bundled in the Sysmac Studio.)	Ver.2.51
OMRON	Sysmac Studio project file	OMRON_3G3MX2_DN_EV100.S MC	Ver.1.00
OMRON	CX-Integrator project file	OMRON_3G3MX2_DN_EV100.cin	Ver.1.00
-	Personal computer (OS: Windows 7)	-	
-	USB cable (USB 2.0 type B connector)	-	
OMRON	Inverter	3G3MX2-A2015	Ver.1.1
OMRON	DeviceNet Communications Unit	3G3AX-MX2-DRT-E	



### Precautions for Correct Use

To use configuration files, prepare the latest "Sysmac Studio project file" and "CX-Integrator project file" in advance.

(To obtain the files, contact your OMRON representative.)



### Additional Information

For information on the DeviceNet cable and network wiring, refer to *Section 2 Network Configuration and Wiring* in the *DeviceNet Operation Manual* (Cat.No. W267).

Connect a terminating resistance to each end of the trunk line of the DeviceNet.



### **Additional Information**

---

In this document, a USB is used to connect with the Controller. For information on how to install a USB driver, refer to *A-1 Driver Installation for Direct USB Cable Connection* of the *Sysmac Studio Version 1 Operation Manual* (Cat.No. W504).

---

## 6. DeviceNet Settings

This section provides specifications such as communications parameters and variable names that are defined in this document.

Hereinafter, the Inverter is referred to as "destination device" in some descriptions.

### 6.1. DeviceNet Communications Settings

The following are the settings for DeviceNet.

	CJ1W-DRM21	Inverter
Unit number	0	-
Node address (MAC ID)	63	0
Baud rate (bps)	500 kbps	(Automatically sets the same setting as for the Master Unit)

### 6.2. Allocation of Remote I/O Communications

The remote I/O communication data of the destination device are allocated to Controller's global variables. An allocation of the remote I/O communication data is called a scan list. The relationship between the device data and the global variables is shown below. The following global variables are defined in "Configuration file".

#### ■ Output area (Controller → Inverter)

Offset	Destination device data	Memory used for CJ-series Unit	Global variable name	Data type
+0	Command	%3200	DN00_CMD_OUT	BOOL [16]
+1	Rotation Speed Reference	%3201	DN00_DATA_OUT	WORD

#### ■ Input area (Controller ← Inverter)

Offset	Destination device data	Memory used for CJ-series Unit	Global variable name	Data type
+0	Status information	%3300	DN00_STA_IN	BOOL[16]
+1	Rotation Speed Monitor	%3301	DN00_DATA_IN	WORD



### Additional Information

When a DeviceNet Unit is used with a Controller, slave data are allocated to the memory used for CJ-series Units. With programs, specify variable names for the memory used for CJ-series Units.

With Sysmac Studio, add the prefix "%" to each address to indicate the memory used for CJ-series Units.

#### ■Details on output area

Global variable	Name		Description
DN00_CMD_OUT[0]	FW	Forward/Stop	0: Stop 1: Forward
DN00_CMD_OUT[1]	RV	Reverse/Stop	0: Stop 1: Reverse
DN00_CMD_OUT[2]	RS	Reset	0: - 1: Fault reset
DN00_CMD_OUT[5]	CTR	Net Ctrl.	0: Follow the setting of parameter A002. 1: Follow the reference from network control.
DN00_CMD_OUT[6]	REF	Net Ref.	0: Follow the setting of parameter A001. 1: Follow the reference from network control.
DN00_DATA_OUT	Rotation Speed Reference		If parameter P049 (Number of Poles for Rotation Speed Setting) is set appropriately, the rotational speed unit is [ $\text{min}^{-1}$ ]. If parameter P049 (Number of Poles for Rotation Speed Setting) is set to 0, the frequency unit is [0.01 Hz].

## ■Details on input area

Global variable	Name		Description			
DN00_STA_IN[0]	AL	Alarm output	0:Normal 1: Fault/Trip			
DN00_STA_IN[1]	WR	Warning	0:Normal 1:Warning			
DN00_STA_IN[2]	FWR	During forward operation	0:During reverse run/Stopping 1: During forward run			
DN00_STA_IN[3]	RVR	During reverse operation	0:During forward run/Stopping 1:During reverse run			
DN00_STA_IN[4]	IRDY	Operation ready	0:Not ready 1:Ready			
DN00_STA_IN[5]	CFN	Ctrl. from Net	0:Follow the setting of parameter A002. 1:DeviceNet reference			
DN00_STA_IN[6]	RFN	Ref. from Net	0:Follow the setting of parameter A001. 1:DeviceNet reference			
DN00_STA_IN[7]	FA1	Constant speed reached	0:Accelerating or decelerating/Stopping 1:Frequency agree			
DN00_STA_IN[8] to DN00_STA_IN[15]	Drive Status	DN00_STA_IN [15] to [11]	[10]	[9]	[8]	
		1: Startup	0	0	0	1
		2: Not ready	0	0	1	0
		3: Ready	0	0	1	1
		4: Operation in progress	0	1	0	0
		5: Stopping	0	1	0	1
		6: Fault/Trip stop	0	1	1	0
7: Fault/Trip	0	1	1	1		
DN00_DATA_IN	Rotation Speed Monitor	If parameter P049 (Number of Poles for Rotation Speed Setting) is set appropriately, the rotational speed unit is [min <sup>-1</sup> ]. If parameter P049 (Number of Poles for Rotation Speed Setting) is set to 0, the frequency is monitored in units of [0.01 Hz].				

## 7. Connection Procedure

This section describes how to connect the Controller on the DeviceNet network using the "procedures for using configuration files".

This document explains the procedures for setting up the Controller and Inverter from the factory default setting. For the initialization, refer to *Section 8 Initialization Method*.

### 7.1. Overview of Setting Up Remote I/O Communications

The following shows the relationship of processes to operate DeviceNet remote I/O communications using the "procedures for using configuration files".

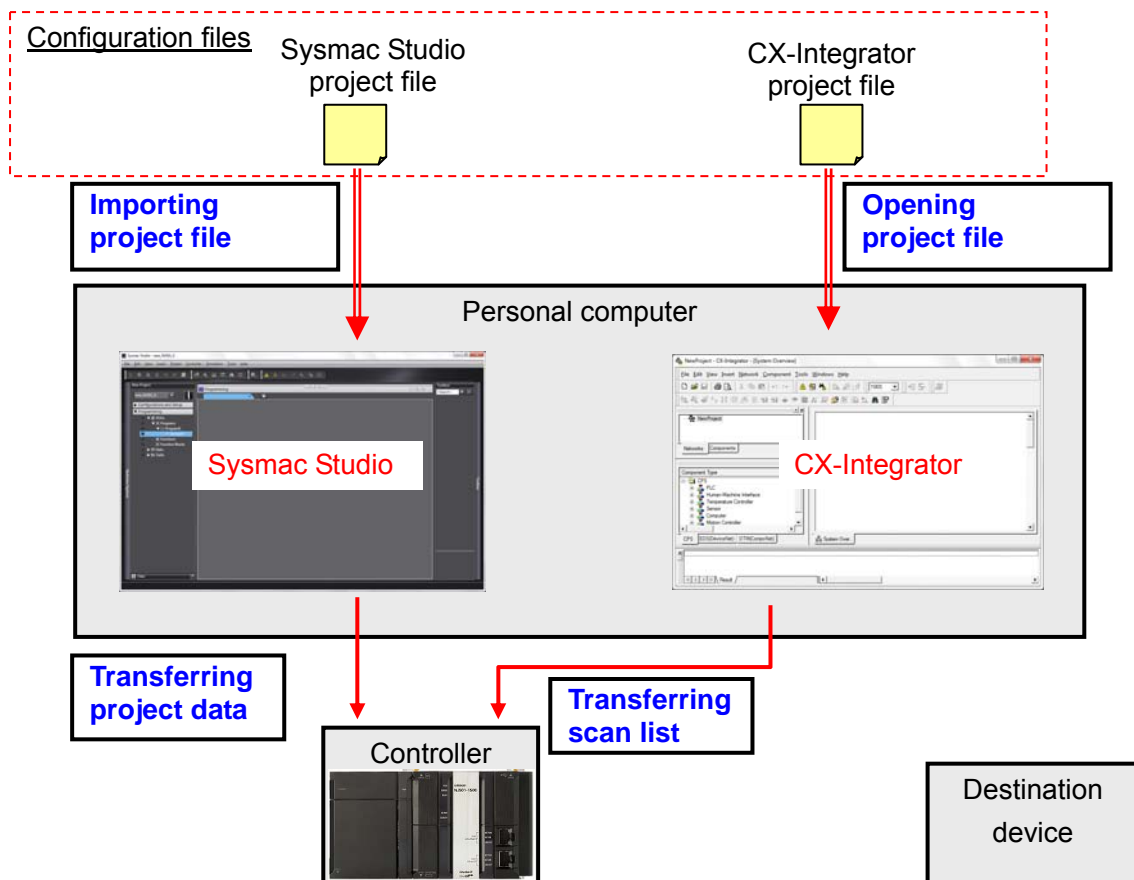

## 7.2. Work Flow

The following is the procedure for making connection settings for remote I/O communications of DeviceNet.

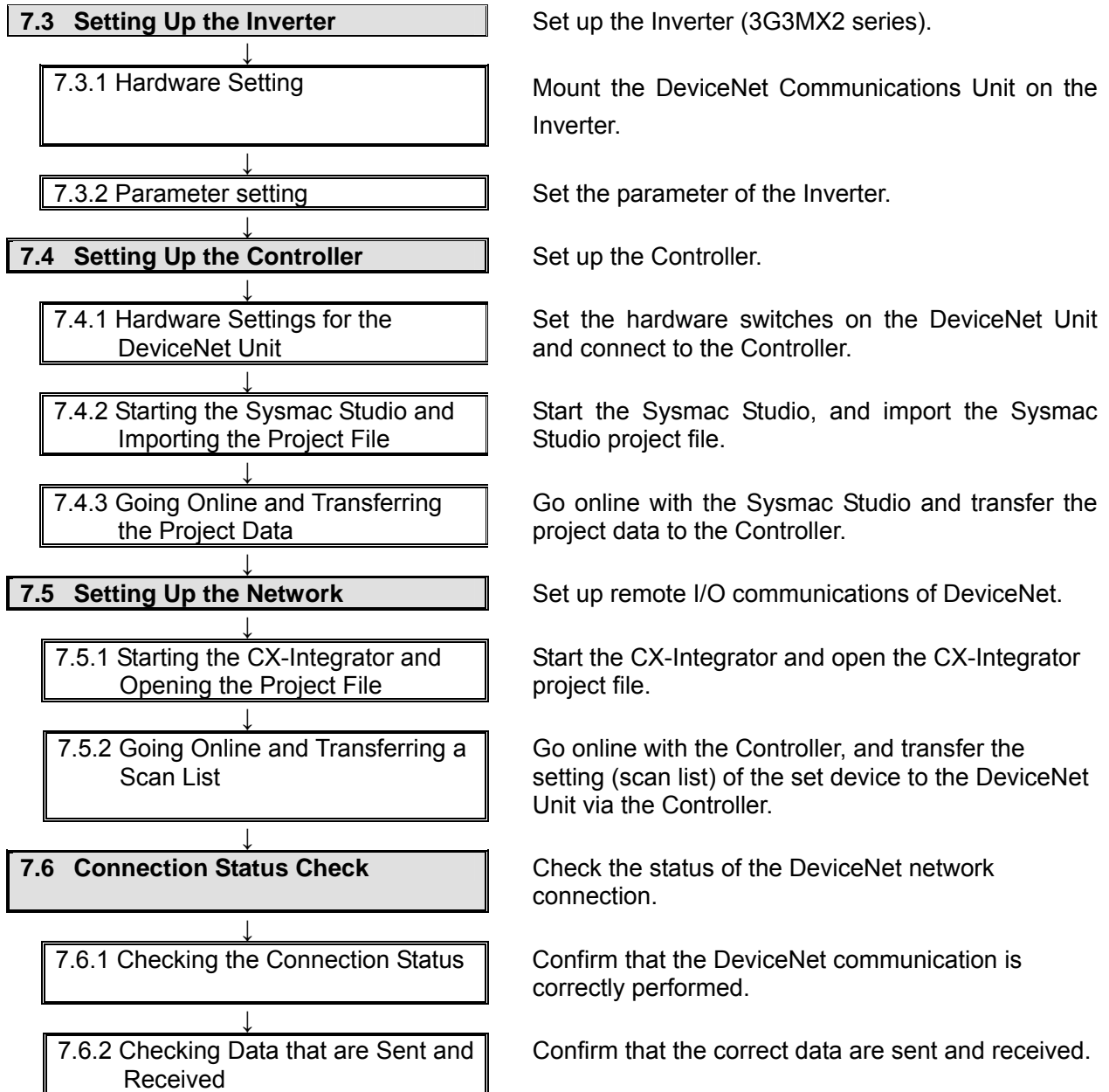

### Precautions for Correct Use

Obtain the latest "Sysmac Studio project file" and "CX-Integrator project file" from OMRON in advance.

(To obtain the files, contact your OMRON representative.)

### 7.3. Setting Up the Inverter

Set up the Inverter (3G3MX2 series).

#### 7.3.1. Hardware Setting

Mount the DeviceNet Communications Unit on the Inverter.



#### Precautions for Correct Use

Make sure that the power supply is OFF when you perform the settings.

- 1 Confirm that the power supply to the Inverter is OFF. \*If the power supply is turned ON, settings may not be applicable as described in the following procedure.

- 2 Refer to the right figure and check the name of each part on the DeviceNet Communications Unit.

•Inverter

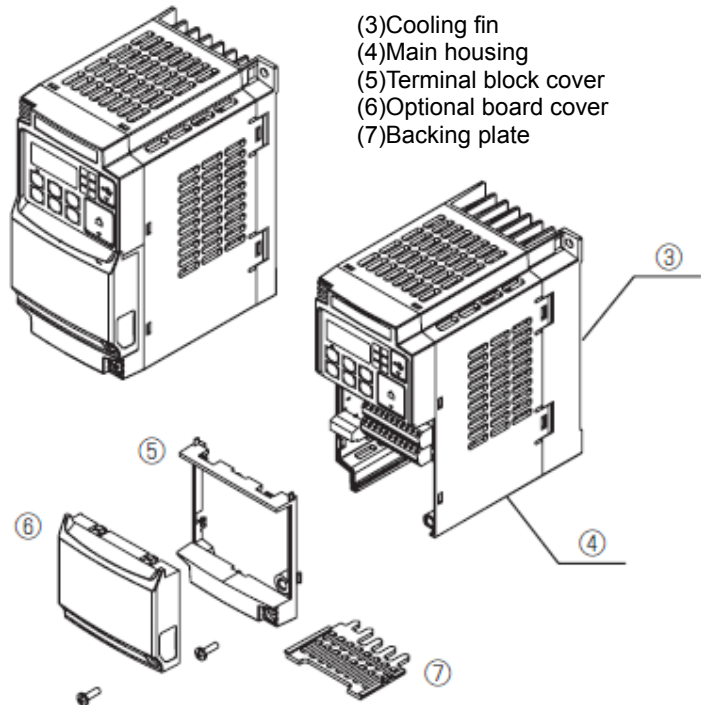

•DeviceNet Communications Unit

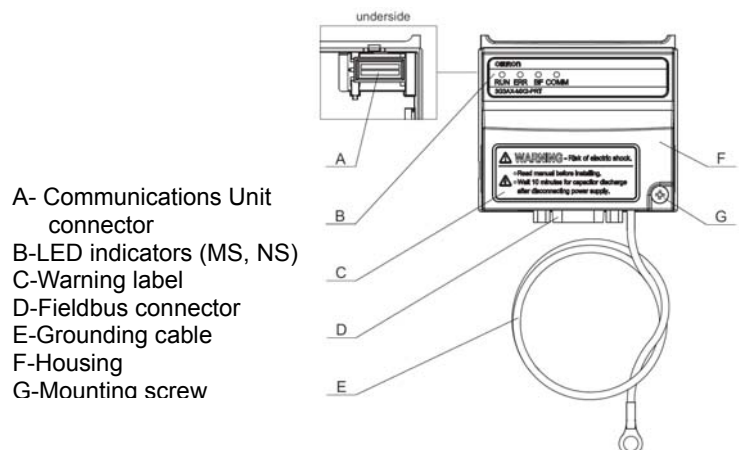



3 Unscrew and remove the optional board cover.

\*For details on how to install the DeviceNet Communications Unit, refer to 2-2 *Installation* in the *DeviceNet Communications Unit User's Manual* (Cat.No. I581).

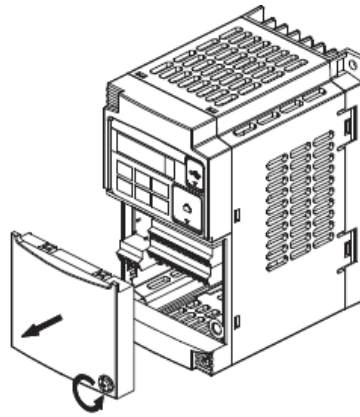

4 Unscrew and remove the terminal block cover.

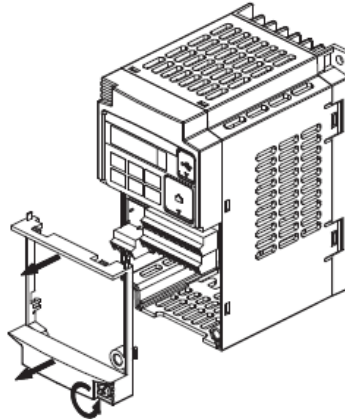

5 Connect the Grounding Cable of the DeviceNet Communications Unit to the Inverter.

1-phase 200 V 0.1 - 2.2 kW  
3-phase 200 V 0.1 - 3.7 kW  
3-phase 400 V 0.4 - 4.0 kW

3-phase 200 V 5.5 - 15 kW  
3-phase 400 V 5.5 - 15 kW

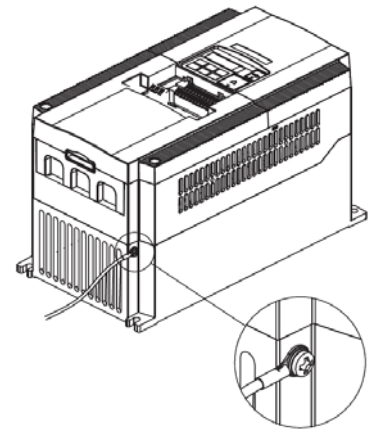
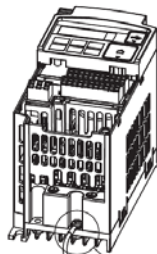

6 If the terminal block cover is removed, mount it again and tighten the screw.

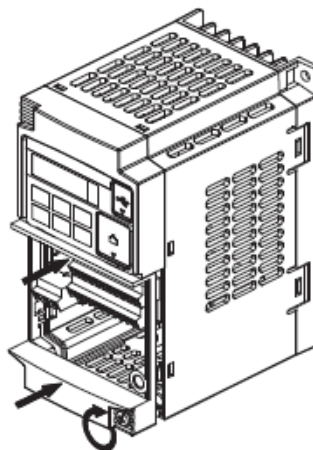

- 7 Push the DeviceNet Communications Unit at the position of the optional cover until it clicks into place.

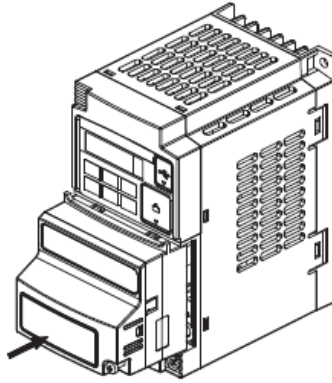

- 8 Press down on the indicated top-left corner of the DeviceNet Communications Unit and ensure the connector of the DeviceNet Communications Unit is properly connected.

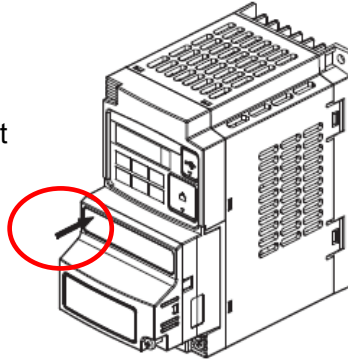

- 9 Confirm that there is no gap between the top edges of the DeviceNet Communications Unit and the Inverter casing.

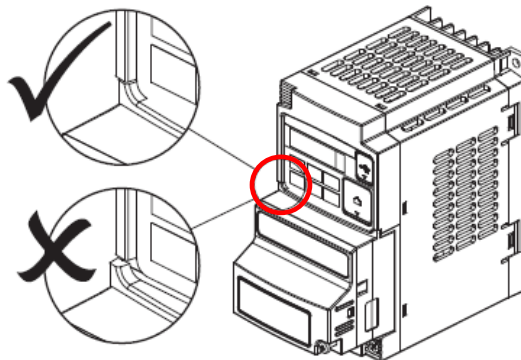

- 10 Secure the DeviceNet Communications Unit to the Inverter with a mounting screw.

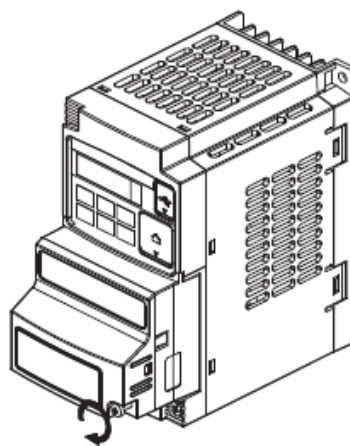

7.3.2. Parameter setting

Set the parameters (node address) of the Inverter.



Additional Information

Make sure that the DeviceNet is not connected when you perform the settings.

- 1 Turn ON the power supply to the Inverter.

\*Set the parameters by using the digital operator that is on the front of the Inverter.

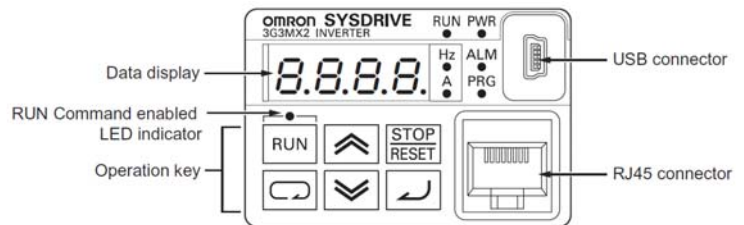

	Display	Various parameters, frequency/set value and other data are displayed (red).
	RUN key	Runs the Inverter. Take note that this key is enabled only when the RUN command destination is the Digital Operator.
	STOP/RESET Key	This key decelerates the Inverter to a stop. (Although the STOP/RESET key is enabled even when a RUN command is issued to a destination other than the Digital Operator (factory default), it can be disabled by a Setting (b087).) If the Inverter is already tripped, the trip will be reset (return from the tripping).
	Mode key	Parameter is displayed: Move to the beginning of the next function group. Data is displayed: Cancel the setting and return to the parameter display. Individual input mode: Move the blinking digit to the left. Regardless of the displayed screen, pressing and holding this key (for 1 second or more) displays the data for Output Frequency Monitor (d001).
 	Increment key Decrement key	These keys are used to increment/decrement a parameter or set data. Pressing and holding each key increases the incrementing/decrementing speed. Pressing the Increment and Decrement keys together activates the "Individual Input MODE" where each digit can be edited independently.
	Enter key	Parameter is displayed: Move to the data display. Data is displayed: Confirm/store the setting (in the EEPROM) and return to the parameter display. Individual input mode: Move the blinking digit to the right.

- 2 After turning ON the power supply, the panel displays as shown on the right.  
Use the procedure on the right to set the parameter.

0.00

After turning ON the power supply, the panel displays as shown on the left.



Press the  Mode Key 3 times.

A001

A001 parameter is displayed.



Press the  Enter Key.

- [A001] Frequency Reference Selection 1: 04  
[A002] RUN Command Selection 1: 04

02

The initial data is displayed.



Press the  Increment Key twice.

\*Set "04" (optional board).

04

Change the data to "04".

- \*When the power supply is turned ON, the data of d001 (Output frequency monitor) is displayed.  
(In the case of factory default value)



Press the  Enter Key.

A001

The parameter is displayed again.



Press the  Increment Key once.

A002

A002 parameter is displayed.



Press the  Enter Key.

02

The initial data is displayed.



Press the  Increment Key two times.

04

Change the data to "04".



Press the  Enter Key.

A002

The parameter is displayed again.

3 Use the procedure on the right to set the display selection.

[b037] Display selection: 01

\*Set "01" (Individual display of functions).

\*The parameters on the following step are not displayed when the factory default setting (04: Basic display) is used.

A002

The parameter is displayed.



Press the  Mode Key once.

b001

b001 parameter is displayed.



Press the  Increment Key four times.

b037

b037 parameter is displayed.



Press the  Enter Key.

04

The initial data is displayed.



Press the  Increment Key four times.

00

Change the data to "00".



Press the  Enter Key.

b037

The parameter is displayed again.

- 4 Use the procedure on the right to set the parameter.

[C102] Reset selection: 03.

\*Set "03" (Trip reset only).

6037

The parameter is displayed.



Press the  Mode Key once.

0001

C001 parameter is displayed.



Press the  Increment Key to move to C102.

C 102

C102 parameter is displayed.



Press the  Enter Key.

00

The initial data is displayed.



Press the  Increment Key three times.

03

Change the data to "03".



Press the  Enter Key.

C 102

The parameter is displayed again.

5 Use the procedure on the right to set the node address of DeviceNet.

[P192] Node address: 0

\*Set the node address to "0".

C 102

The parameter is displayed.



Press the  Mode Key several times.

P001

P001 parameter is displayed.



Press the  Increment Key to move to P192.

P 192

C192 parameter is displayed.



Press the  Enter Key.

63

The current node is displayed.



Press the  Decrement Key sixty three times.

0

Change the data to "00".



Press the  Enter Key.

P 192

The parameter is displayed again.

6 Turn OFF the power supply to the Inverter.

Connect the DeviceNet cable.

Cycle the power supply to the Inverter.

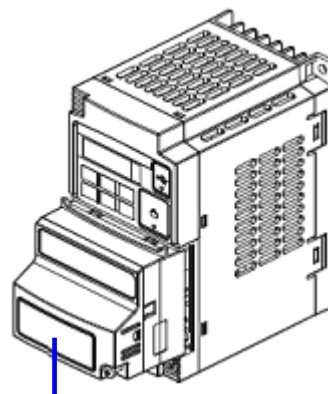

T-branch Tap (DCN1-1C)

DeviceNet cable



## 7.4. Setting Up the Controller

Set up the Controller.

### 7.4.1. Hardware Settings for the DeviceNet Unit

Set the hardware switches on the DeviceNet Unit and connect to the Controller.



#### Precautions for Correct Use

Make sure that the power supply is OFF when you perform the settings.

- 1 Make sure that the power supply to the Controller is OFF when you perform settings.

\*If the power supply is turned ON, settings may not be applicable as described in the following procedure.

- 2 Refer to the figure on the right and check the hardware switches on the front panel of the DeviceNet Unit.

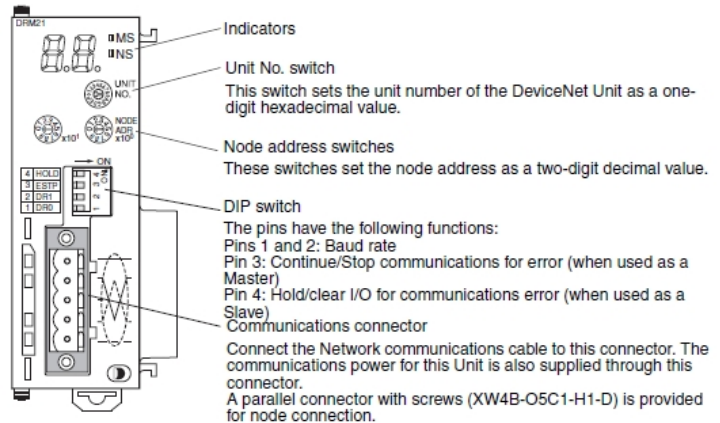

- 3 Set the Unit No. Switch to 0.



Setting method: One-digit hexadecimal

Setting range: 0 to F

Note 1 The unit number is set to 0 at the factory.

- 4 Set the Node Address Switches to 63.



Setting method: Two-digit decimal

Setting range: 0 to 63

Note. The node address is set to 63 at the factory.



5 Set pin 2 of the DIP switch to ON. (Set pins 1, 3 and 4 of the DIP switch to OFF.)

\*Set the baud rate to 500 kbps.

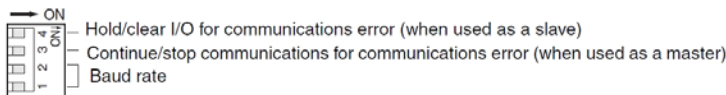

Pin	Function	Setting
1	Baud rate	See the next table.
2		
3	Continue/stop remote I/O communications for communication errors (when used as a master)	OFF: Continue communications ON: Stop communications
4	Hold/clear remote outputs for communications error (when used as a slave)	OFF: Clear remote outputs ON: Hold remote outputs

Pin 1	Pin 2	Baud rate
OFF	OFF	125 kbps
ON	OFF	250 kbps
OFF	ON	500 kbps
ON	ON	Not allowed.

All pins are set to OFF at the factory.

6 Connect the DeviceNet Unit and the End Cover to the Controller. Connect the personal computer, Inverter and Controller using the DeviceNet cable and USB cable as shown in 5.2 Device Configuration. Turn ON the power supply to the Controller and DeviceNet.



### 7.4.2. Starting the Sysmac Studio and Importing the Project File

Start the Sysmac Studio, and import the Sysmac Studio project file.

Install the Sysmac Studio and USB driver in the personal computer beforehand.

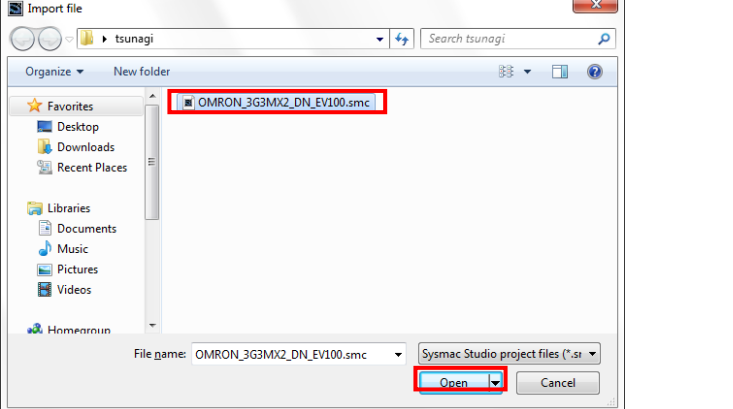
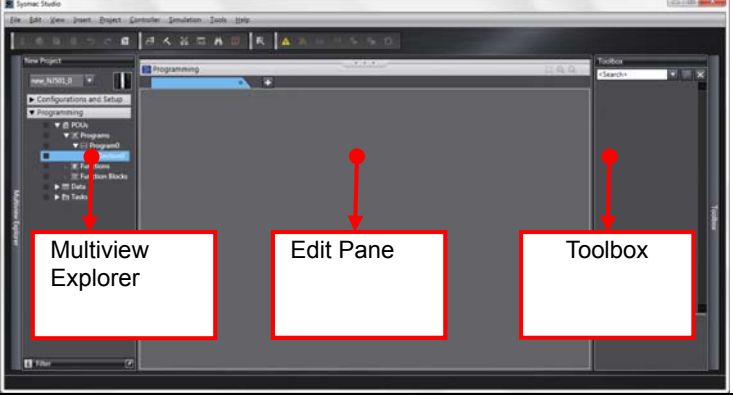
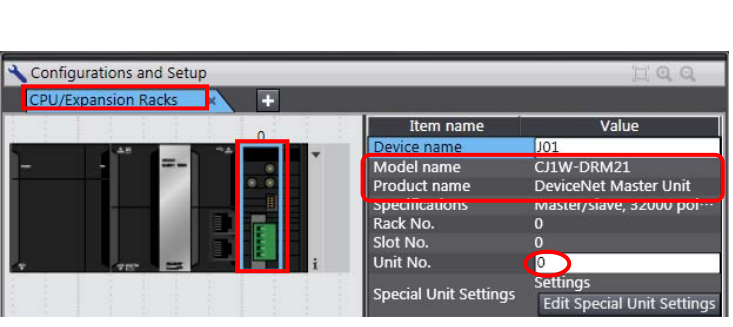
<p>1 Start the Sysmac Studio. Click the <b>Import</b> Button.</p> <p>*If a dialog box is displayed at start confirming the access right, select an option to start.</p>																			
<p>2 The Import File Dialog Box is displayed. Select OMRON_3G3MX2_DN_EV100.SMC (Sysmac Studio project file) and click the <b>Open</b> Button.</p> <p>*Obtain the Sysmac Studio project file from OMRON.</p>																			
<p>3 The OMRON_3G3MX2_DN_EV100 project is displayed. The left pane is called Multiview Explorer, the right pane is called Toolbox and the middle pane is called Edit Pane.</p>																			
<p>4 Double-click CPU/Expansion Racks under Configurations and Setup in the Multiview Explorer, and select the DeviceNet Unit. Confirm that CJ1W-DRM21 is displayed and the unit number is 0 as shown in the right figure.</p>	 <table border="1" data-bbox="1077 1736 1436 1937"> <thead> <tr> <th>Item name</th> <th>Value</th> </tr> </thead> <tbody> <tr> <td>Device name</td> <td>J01</td> </tr> <tr> <td>Model name</td> <td>CJ1W-DRM21</td> </tr> <tr> <td>Product name</td> <td>DeviceNet Master Unit</td> </tr> <tr> <td>Specifications</td> <td>master/slave, 32000 poi...</td> </tr> <tr> <td>Rack No.</td> <td>0</td> </tr> <tr> <td>Slot No.</td> <td>0</td> </tr> <tr> <td>Unit No.</td> <td>0</td> </tr> <tr> <td>Special Unit Settings</td> <td>Edit Special Unit Settings</td> </tr> </tbody> </table>	Item name	Value	Device name	J01	Model name	CJ1W-DRM21	Product name	DeviceNet Master Unit	Specifications	master/slave, 32000 poi...	Rack No.	0	Slot No.	0	Unit No.	0	Special Unit Settings	Edit Special Unit Settings
Item name	Value																		
Device name	J01																		
Model name	CJ1W-DRM21																		
Product name	DeviceNet Master Unit																		
Specifications	master/slave, 32000 poi...																		
Rack No.	0																		
Slot No.	0																		
Unit No.	0																		
Special Unit Settings	Edit Special Unit Settings																		

### 7.4.3. Going Online and Transferring the Project Data

Go online with the Sysmac Studio and transfer the project data to the Controller.

## WARNING

Always confirm safety at the destination node before you transfer a user program, configuration data, setup data, device variables, or values in memory used for CJ-series Units from the Sysmac Studio.

The devices or machines may perform unexpected operation regardless of the operating mode of the CPU Unit.



## Caution

Always confirm safety before you reset the Controller or any components.



- 1 Select **Communications Setup** from the Controller Menu.

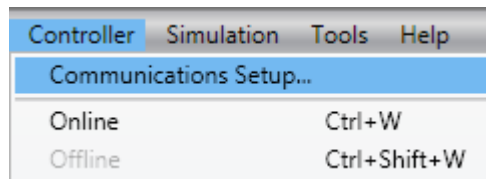

- 2 The Communications Setup Dialog Box is displayed. Select the *Direct connection via USB* Option in the Connection Type Field.

Click the **OK** Button.

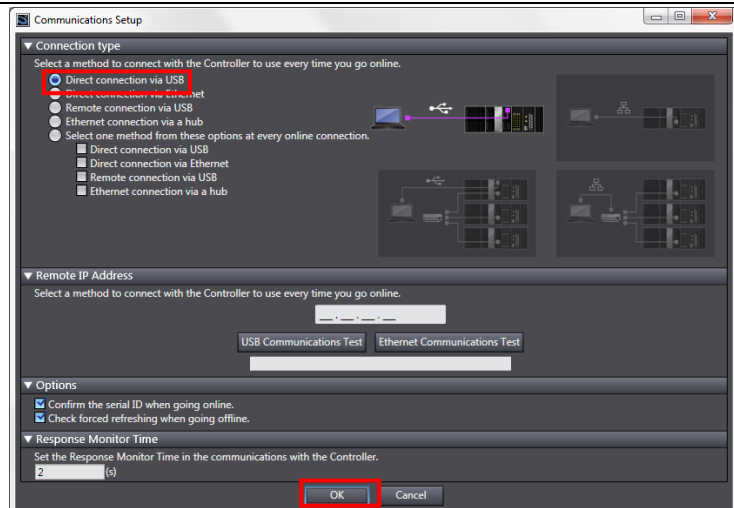

### Additional Information

For details on the online connections to a Controller, refer to *Section 5 Going Online with a Controller* in the *Sysmac Studio Version 1 Operation Manual* (Cat. No. W504).

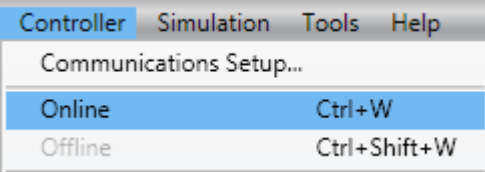
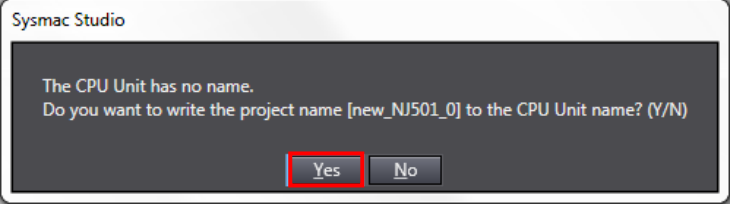
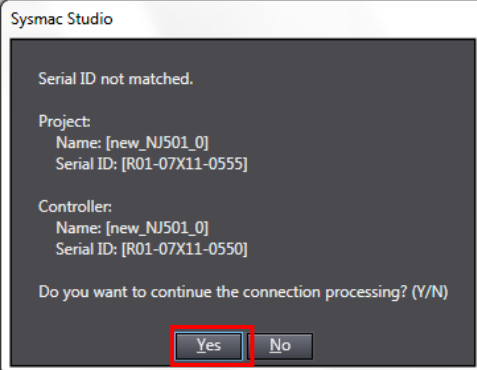
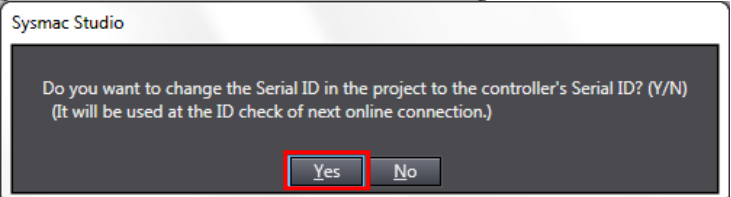
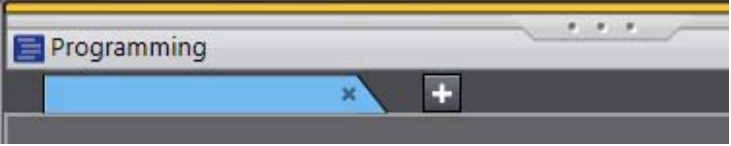
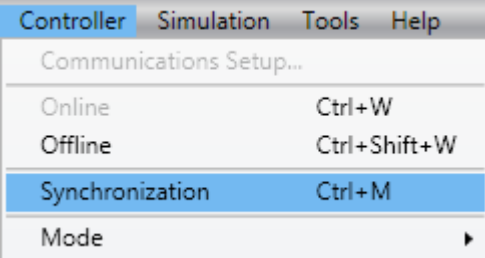
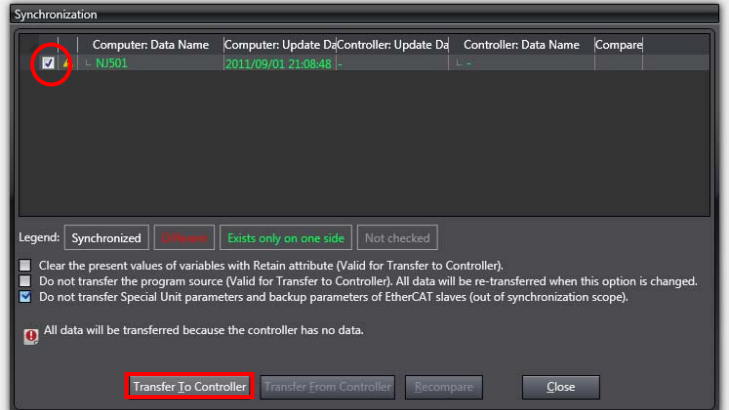
<p>3 Select <b>Online</b> from the Controller Menu.</p> <p>A confirmation dialog is displayed. Click the <b>Yes</b> Button.</p> <p>*A displayed dialog depends on the status of the Controller used. Select the <b>Yes</b> Button or other button to proceed with the processing.</p> <p>*Displayed serial ID differs depending on the device.</p>	   
<p>4 When an online connection is established, a yellow bar is displayed on the top of the Edit Pane.</p>	
<p>5 Select <b>Synchronization</b> from the Controller Menu.</p>	
<p>6 The Synchronization Dialog Box is displayed. Confirm that the data to transfer (NJ501 in the right figure) is selected. Then, click the <b>Transfer to Controller</b> Button.</p>	

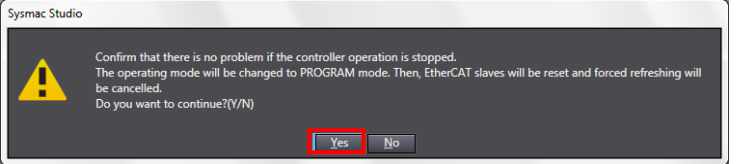
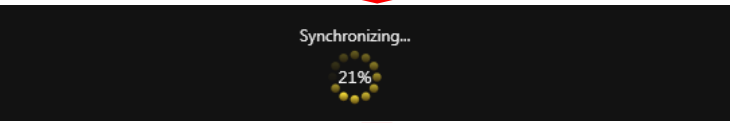
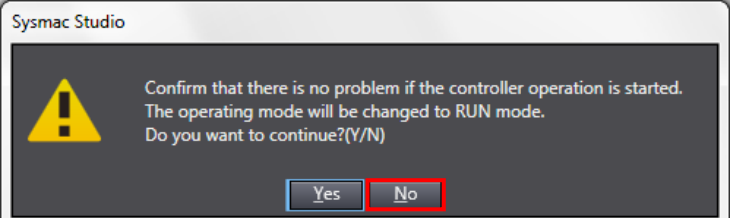
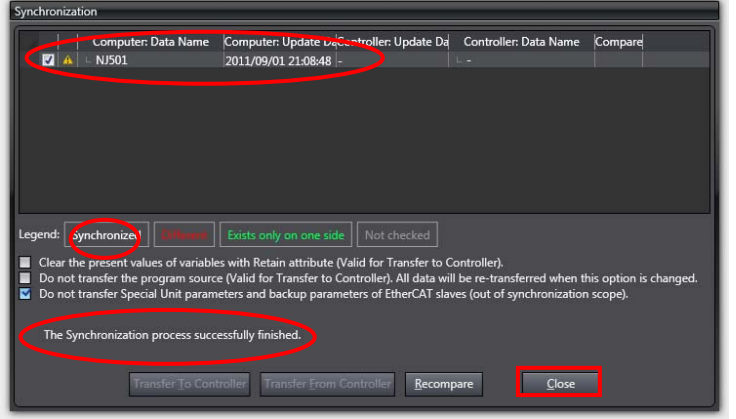
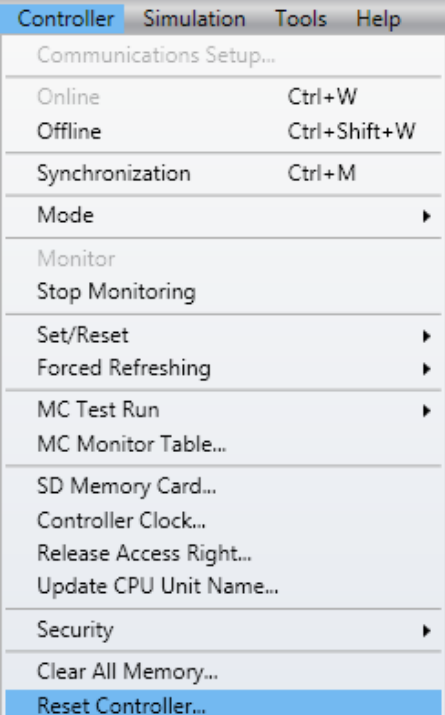
<p>7 A confirmation dialog is displayed. Click the <b>Yes</b> Button.</p> <p>A screen stating "Synchronizing" is displayed.</p> <p>A confirmation dialog box is displayed. Click the <b>No</b> Button.</p>	  
<p>8 Confirm that the synchronized data is displayed with the color specified by "Synchronized", and that a message is displayed stating "The synchronization process successfully finished". If there is no problem, click the <b>Close</b> Button.</p> <p>*If the synchronization fails, check the wiring and repeat the procedure described in this section.</p>	
<p>9 Select <b>Reset Controller</b> from the Controller Menu.</p> <p>*When Mode is set to RUN Mode, Reset Controller cannot be selected. In this case, select <b>Mode - PROGRAM Mode</b> from the Controller Menu to change to PROGRAM mode and perform the procedure in this step.</p>	

- 10 A confirmation dialog box is displayed several times. Click the **Yes** Button.

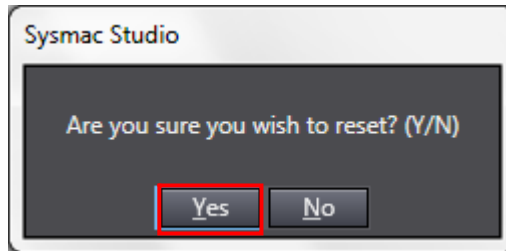
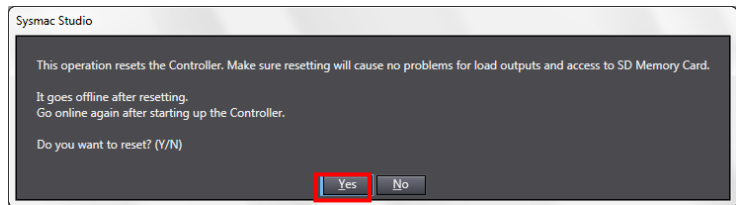

- 11 The controller is reset, and Sysmac Studio goes offline. The yellow bar on the top of the Edit Pane disappears. Use steps 1 to 4 to go online.



## 7.5. Setting Up the Network

Set up remote I/O communications of DeviceNet.

### 7.5.1. Starting the CX-Integrator and Opening the Project File

Start the CX-Integrator and open the CX-Integrator project file.

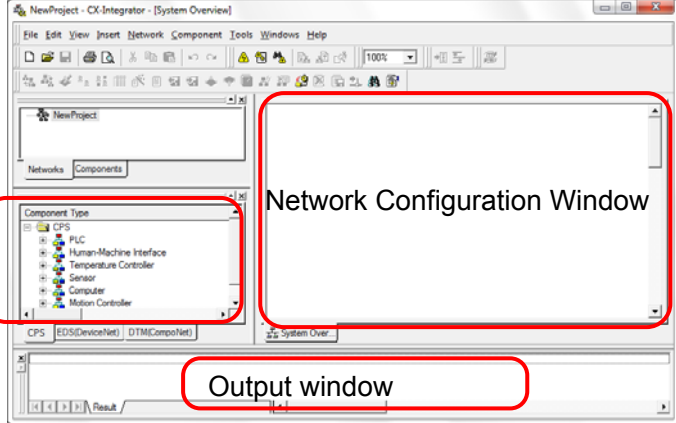
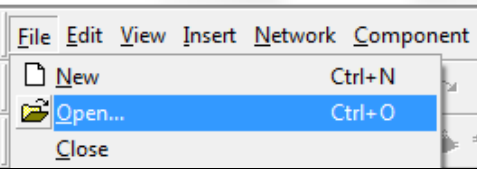
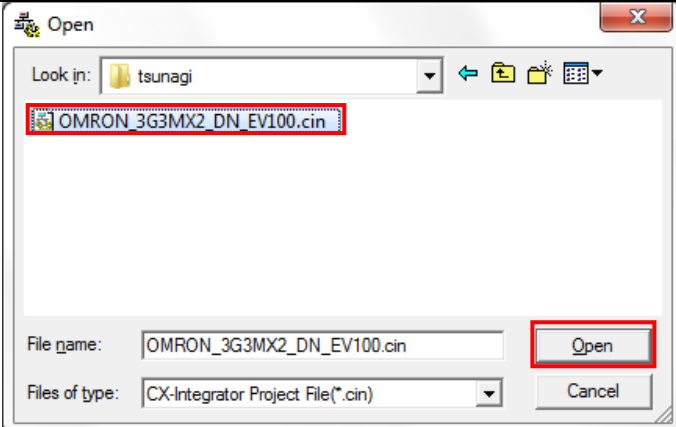
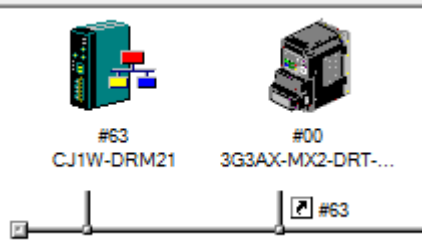
<p>1 Start the CX-Integrator.</p> <p>*If the Component List Window is not displayed, select <b>Windows - Component List Window</b> from the View Menu.</p> <p>Component List Window</p>	
<p>2 Select <b>Open</b> from the File Menu.</p>	
<p>3 The Open Dialog Box is displayed. Select OMRON_3G3MX2_DN_EV100.cin (CX-Integrator project file) and click the <b>Open</b> Button.</p>	
<p>4 The following devices are displayed on the Network Configuration Window as shown in the figure on the right.</p> <p>#63:CJ1W-DRM21 #00:3G3AX-MX2-DRT-AB002-A2002</p>	



#### Precautions for Correct Use

Please confirm that the DeviceNet cable has been connected before proceeding to the following procedures.

If it is not connected, turn OFF the power to the devices, and then connect the DeviceNet cable.

### 7.5.2. Going Online and Transferring the Scan List

Go online with the Controller, and transfer the setting (scan list) of the set device to the DeviceNet Unit via the Controller. When the transfer is completed, remote I/O communications start automatically.

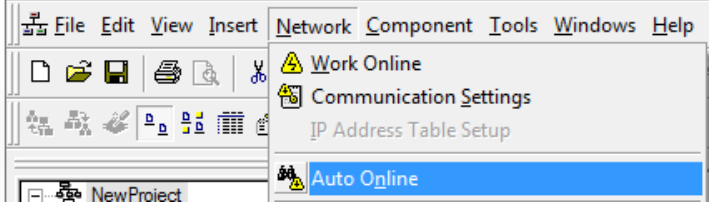
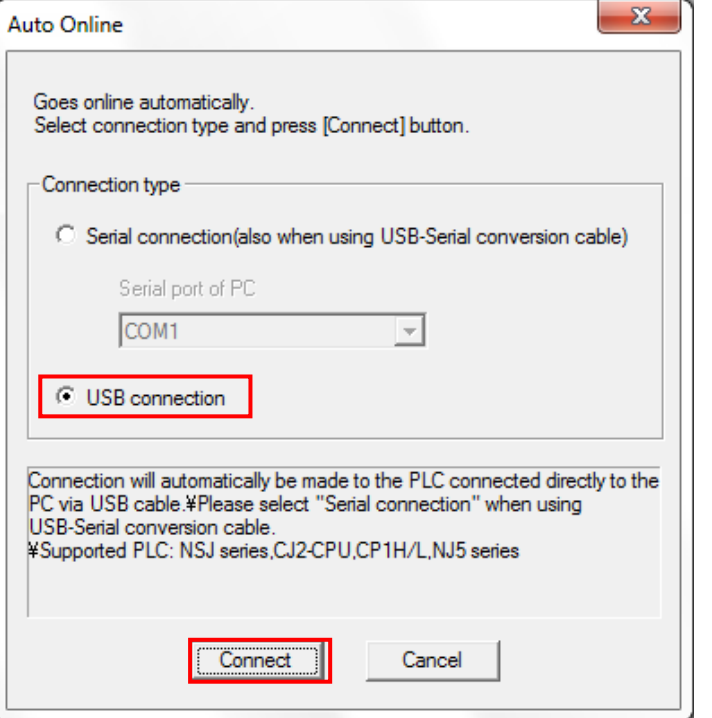
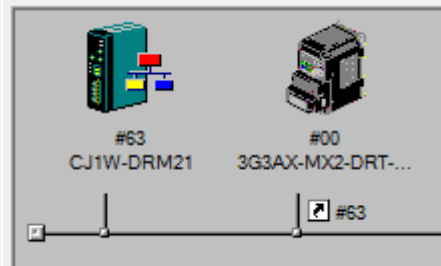
<p>1 Select <b>Auto Online</b> from the Network Menu.</p>	
<p>2 The Auto Online Dialog Box is displayed. Select the <b>USB connection</b> Option in the Connection type Field, and click the <b>Connect</b> Button.</p>	
<p>3 After an online connection is established, the background color of the Network Configuration Window changes as shown in the right figure.</p>	



#### Precautions for Correct Use

If an online connection cannot be made to the Controller, check the cable connection. Or, return to step 1 and check the settings such as a connection type and try again.





#### Additional Information

For details on the online connections to a Controller, refer to *Section 2 Basic Operations in the Communications of the CX-Integrator Ver.2.[J] Operation Manual (W446)*.

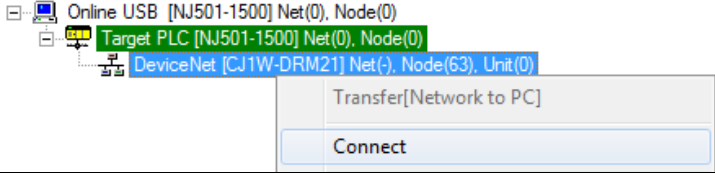

- 4 Right-click DeviceNet in the Online Connection Information Window, and select **Connect**.

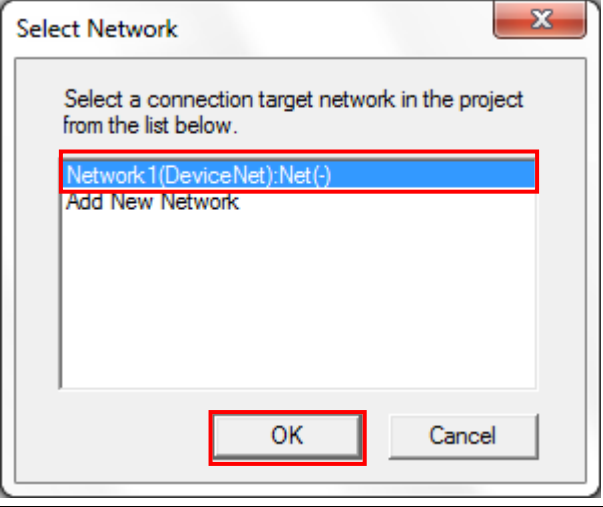

- 5 Select **DeviceNet** in the Select Network Dialog Box, and click the **OK** Button.

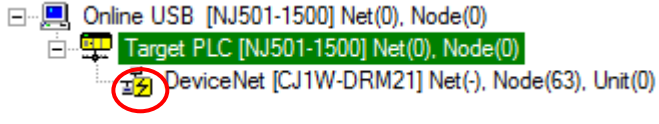
- 6 Confirm that the DeviceNet is in online status (  icon) in the Online Connection Information Window.

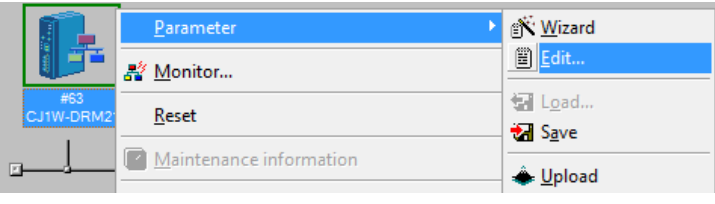

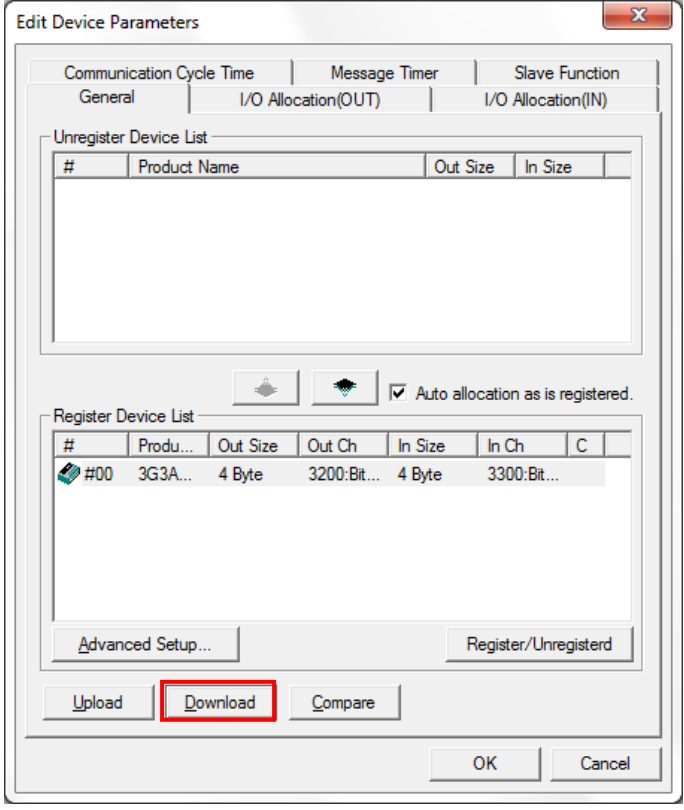
- 7 Right-click CJ1W-DRM21 on the Network Configuration Window, and select **Parameter - Edit**.

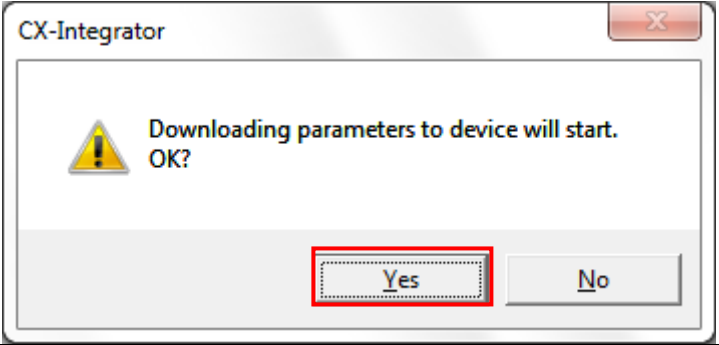
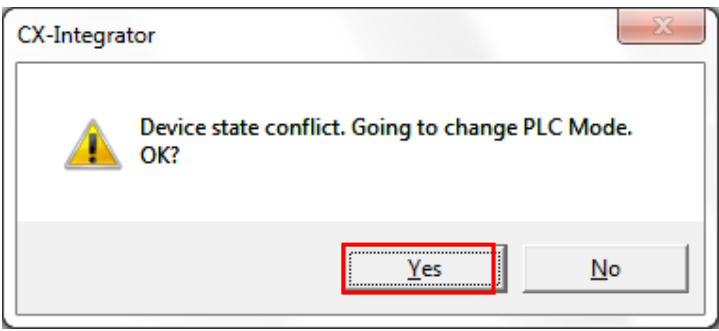
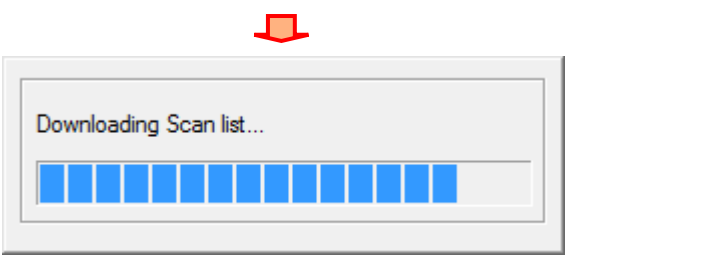
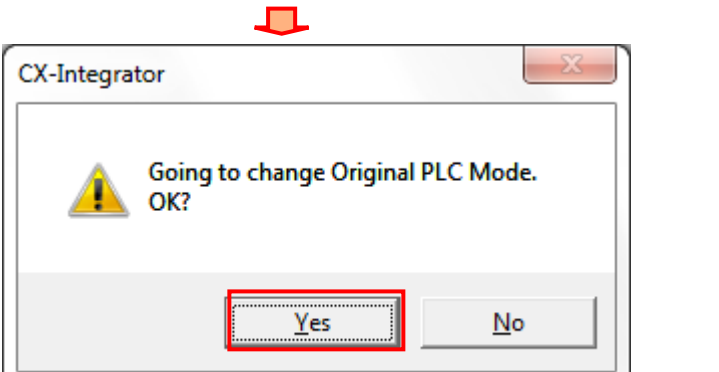
- 8 The Edit Device Parameters Dialog Box is displayed. Click the **Download** Button.

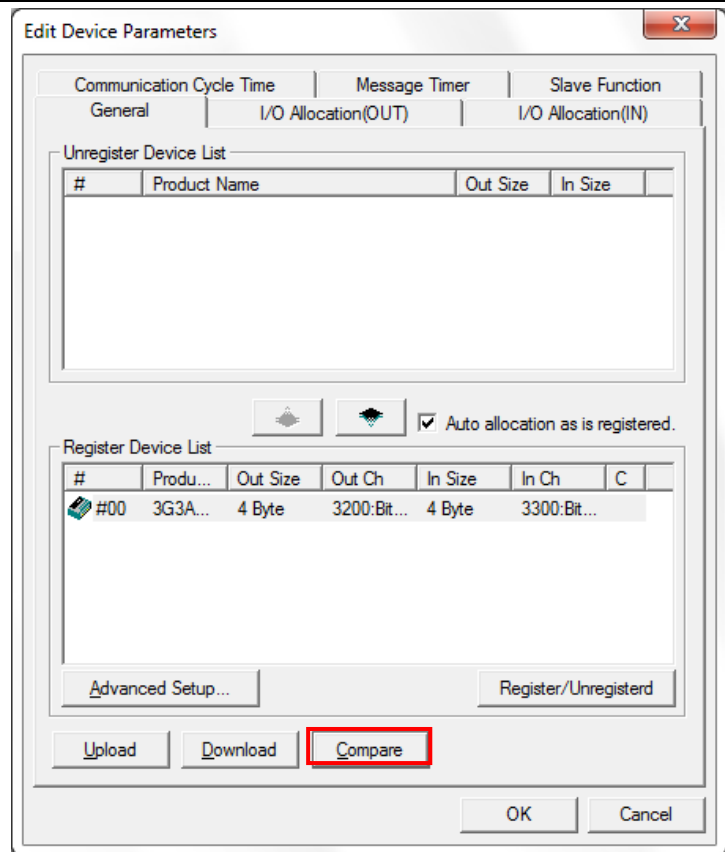

9	A download confirmation dialog box is displayed. Click the <b>Yes</b> Button to download the parameters.	
10	A dialog box is displayed confirming whether to change the mode. Click the <b>Yes</b> Button.	
	A dialog box is displayed indicating downloading is being performed.	
	When downloading is completed, a dialog box is displayed confirming whether to change the mode. Click the <b>Yes</b> Button.	

- 11 The Edit Device Parameters Dialog Box is displayed again. Click the **Compare** Button.



- 12 A dialog box shown on the right is displayed. Click the **Yes** Button to compare the parameters.

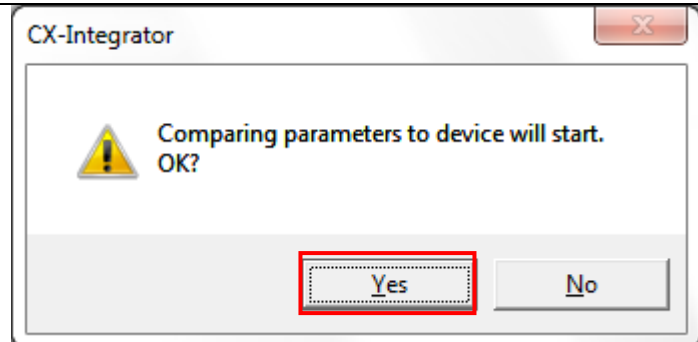

When the comparison is completed, a dialog box shown on the right is displayed. Click the **OK** Button.

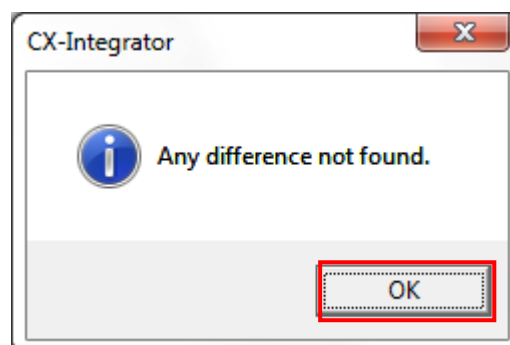

The Edit Device Parameters Dialog Box is displayed again. Click the **OK** Button.

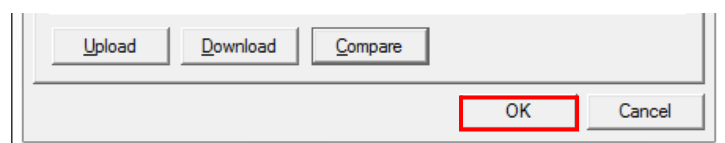

### 7.6. Connection Status Check

Check the status of the DeviceNet network connection.

#### 7.6.1. Checking the Connection Status

Confirm that the DeviceNet communication is working.

- 1 Confirm that the DeviceNet communications are performed normally by checking the LED indicators on each unit.
  - DeviceNet Unit
    - LED indicators in normal status
    - MS: Green ON
    - NS: Green ON
    - During normal operation, the 7-segment display shows 63. (63: Master node address, remote I/O communications active and normal)

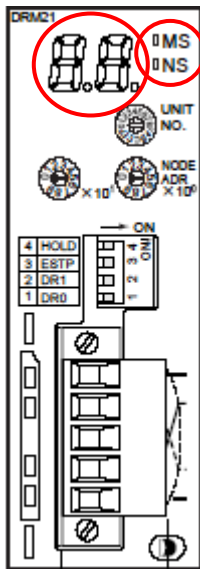

(DeviceNet Unit)

- Inverter
  - LED indicators in normal status
  - MS: Green ON
  - NS: Green ON

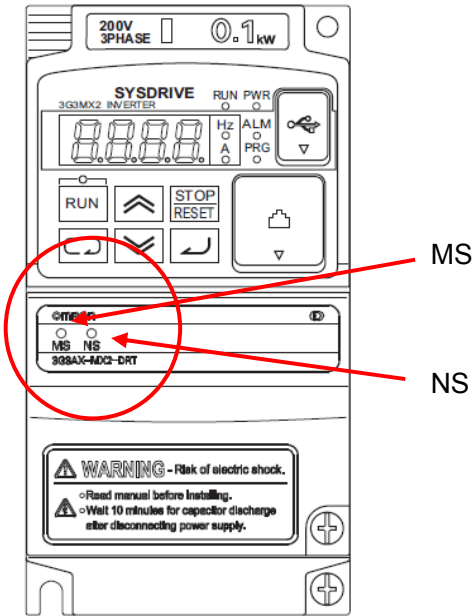

(Inverter)

- 2 To confirm if the DeviceNet communications are performed normally from the CX-Integrator, refer to the status information on the Monitor Device Dialog Box.

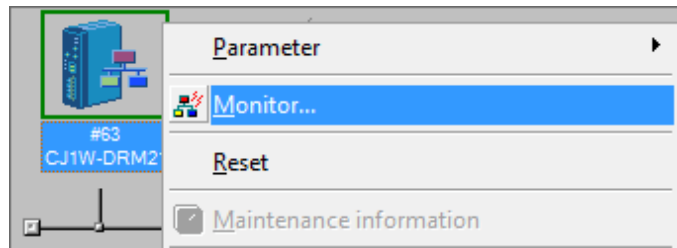

Right-click the master icon on the Network Configuration Window, and select **Monitor**.

- 3 The figure on the right shows the Status Tab Page of the Monitor Device Dialog Box.

DeviceNet communications are normally performed if the items selected in the figure on the right are selected in the Master Status Field, slave #00 is lit blue, and Remote I/O Communications Running is selected.

Click the **Close** Button.

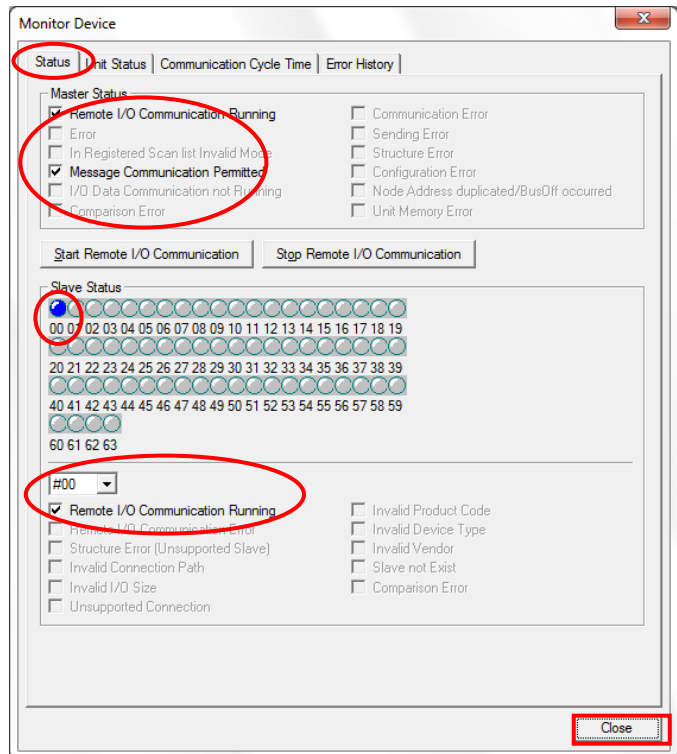

(Monitor Device Dialog Box)

- 4 Go offline with the CX-Integrator. Select **Work Online** from the Network Menu.

\*The  icon is not selected during offline connection.

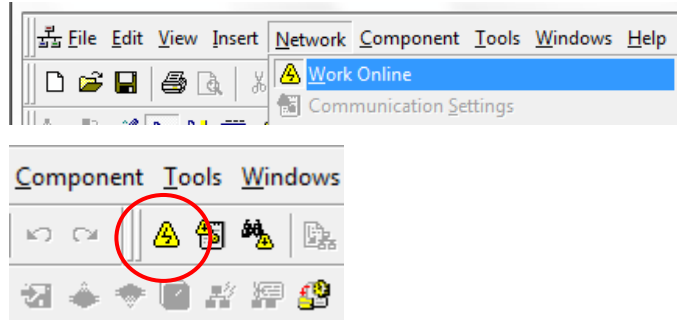

### 7.6.2. Checking Data That Are Sent and Received

Confirm that the correct data are sent and received.

**WARNING**

Always confirm safety at the destination node before you transfer a user program, configuration data, setup data, device variables, or values in memory used for CJ-series Units from the Sysmac Studio.

The devices or machines may perform unexpected operation regardless of the operating mode of the CPU Unit.

**Caution**

The Inverter will run if you proceed to this section. Confirm safety before operation. If you cannot confirm safety, do not proceed to this section after completing until Section 7.6.1.

If you proceed to this section, make sure to complete all the steps and place the Inverter in the safe state.

- 1 Select **Watch Tab Page** from the View Menu.

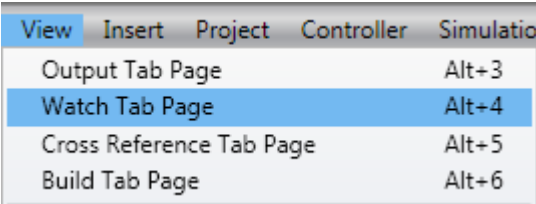
- 2 The Watch Tab Page is displayed in the lower section of the Edit Pane.

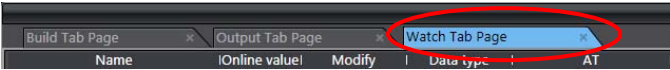
- 3 The following names to monitor are entered in the Watch Tab Page.  
 DN00\_STA\_IN[5]  
 DN00\_STA\_IN[6]  
 DN00\_CMD\_OUT[0]  
 DN00\_DATA\_OUT

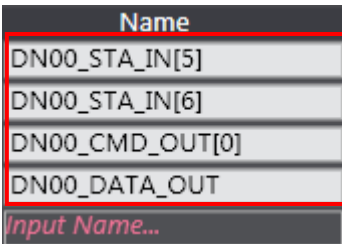
- 4 Set the data type as follows:  
 DN00\_STA\_IN[5]:[Boolean]  
 DN00\_STA\_IN[6]:[Boolean]  
 DN00\_CMD\_OUT[0]:[Boolean]  
 DN00\_DATA\_OUT:[Decimal]

Name	Online value	Modify	Data type	AT	Data format
DN00_STA_IN[5]	True	TRUE FALSE	BOOL		Boolean
DN00_STA_IN[6]	True	TRUE FALSE	BOOL		Boolean
DN00_CMD_OUT[0]	False	TRUE FALSE	BOOL		Boolean
DN00_DATA_OUT	0		WORD	%3201	Decimal
- 5 Confirm that the online values of DN00\_STA\_IN[5] and DN00\_STA\_IN[6] are True.

\*DN00\_STA\_IN[5]:CFN  
 0:Follow the setting of parameter

Name	Online value	Modify	Data type
DN00_STA_IN[5]	True	TRUE FALSE	BOOL
DN00_STA_IN[6]	True	TRUE FALSE	BOOL
DN00_CMD_OUT[0]	False	TRUE FALSE	BOOL
DN00_DATA_OUT	0		WORD

A002.  
1:DeviceNet reference  
\*DN00\_STA\_IN[6]:RFN  
0:Follow the setting of parameter  
A001.  
1:DeviceNet reference

6 Enter 100 in the Modify Column of *DN00\_DATA\_OUT*.  
Press the **Enter** key on a keyboard.  
The Online Value is changed to 100.

Name	Online value	Modify	Data type
DN00_STA_IN[5]	True	TRUE FALSE	BOOL
DN00_STA_IN[6]	True	TRUE FALSE	BOOL
DN00_CMD_OUT[0]	False	TRUE FALSE	BOOL
DN00_DATA_OUT	0	100	WORD

↓

Name	Online value	Modify	Data type
DN00_STA_IN[5]	True	TRUE FALSE	BOOL
DN00_STA_IN[6]	True	TRUE FALSE	BOOL
DN00_CMD_OUT[0]	False	TRUE FALSE	BOOL
DN00_DATA_OUT	100	100	WORD

7 Confirm that RUN LED indicator of the Inverter is unlit and **0.00** is shown on 7-segment display (Output frequency setting).

8 Click **True** in the Modify Column of *DN00\_CMD\_OUT[0]*.  
  
\*DN00\_CMD\_OUT[0]:FW  
0:Stop/1:Forward  
  
The Online Value changes to True.

Name	Online value	Modify	Data type
DN00_STA_IN[5]	True	TRUE FALSE	BOOL
DN00_STA_IN[6]	True	TRUE FALSE	BOOL
DN00_CMD_OUT[0]	False	TRUE FALSE	BOOL
DN00_DATA_OUT	100	100	WORD

↓

Name	Online value	Modify	Data type
DN00_STA_IN[5]	True	TRUE FALSE	BOOL
DN00_STA_IN[6]	True	TRUE FALSE	BOOL
DN00_CMD_OUT[0]	True	TRUE FALSE	BOOL
DN00_DATA_OUT	100	100	WORD

- 9 Confirm that RUN LED indicator of the Inverter is lit and **1.00** is shown on 7-segment display (Output frequency).

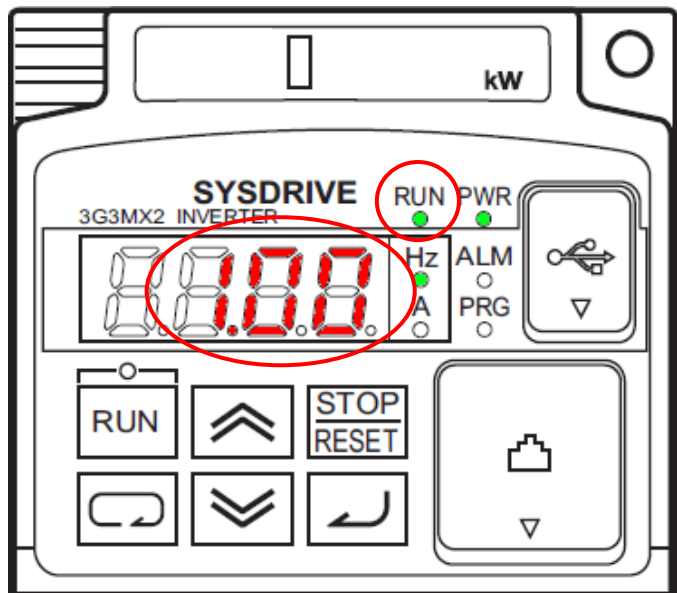

- 10 Click **FALSE** in the Modify Column of *DN00\_CMD\_OUT[0]*.

The Online value changes to False.

Name	Online value	Modify	Data type
DN00_STA_IN[5]	True	TRUE FALSE	BOOL
DN00_STA_IN[6]	True	TRUE FALSE	BOOL
DN00_CMD_OUT[0]	False	TRUE <b>FALSE</b>	BOOL
DN00_DATA_OUT	100	100	WORD

- 11 Confirm that 7-segment LED display (Output frequency) on the front of the Inverter shows **0.00** again and that the RUN LED indicator is not lit.

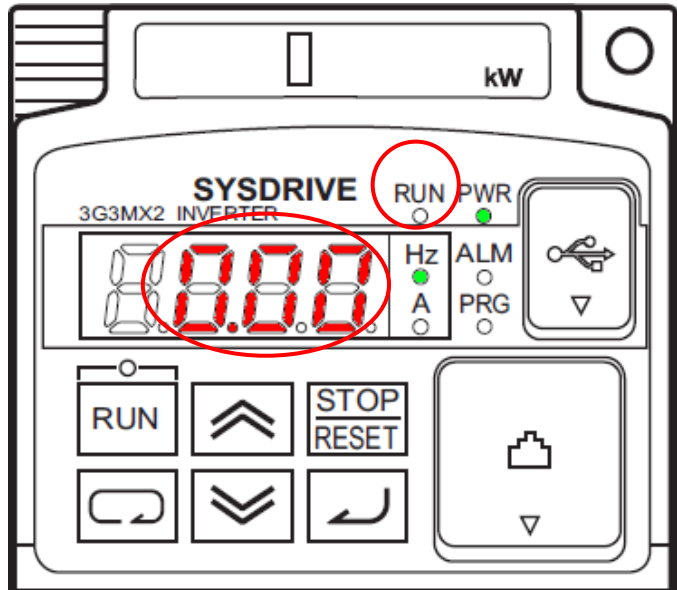



## 8. Initialization Method

This document explains the setting procedure from the factory default setting.

If the device settings have been changed from the factory default setting, some settings may not be applicable as described in this procedure.

### 8.1. Controller

To initialize the Controller, it is necessary to initialize the CPU Unit and DeviceNet Unit. Change to the PROGRAM mode before initialization.

#### 8.1.1. DeviceNet Unit

To initialize the settings of the DeviceNet Unit, select **Edit Special Unit Settings** of CJ1W-DRM21 in CPU/Expansion Racks from the Sysmac Studio.

Select ***Clears the scan list*** from the Scan List Clear Switch.

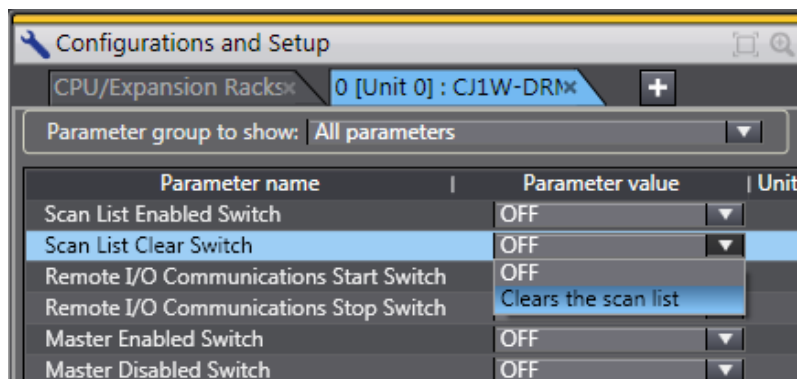

Click the **Apply** Button and the **Transfer to Controller** Button.

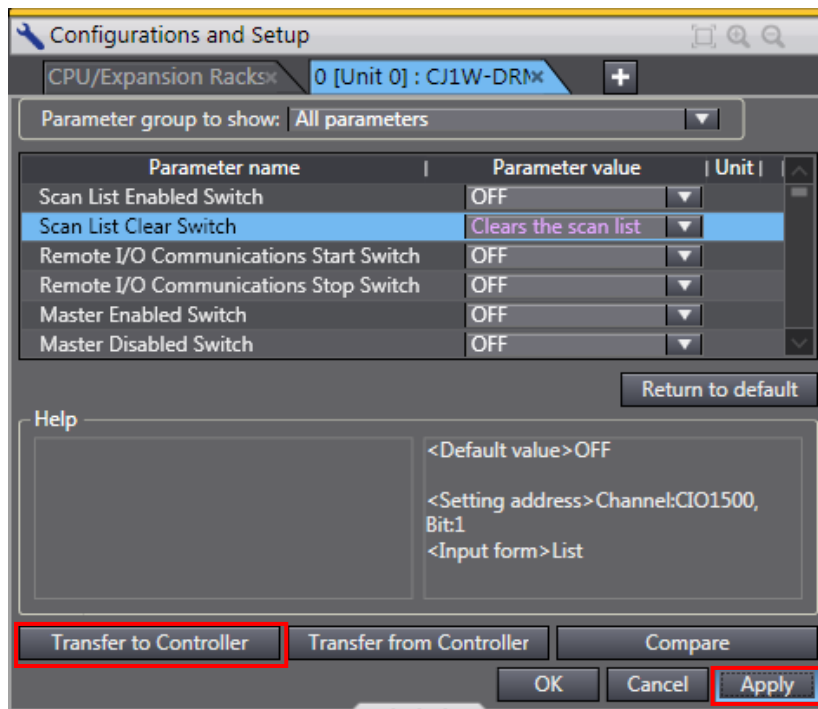

### 8.1.2. CPU Unit

To initialize the settings of the Controller, select **Clear All Memory** from the Controller Menu of the Sysmac Studio.

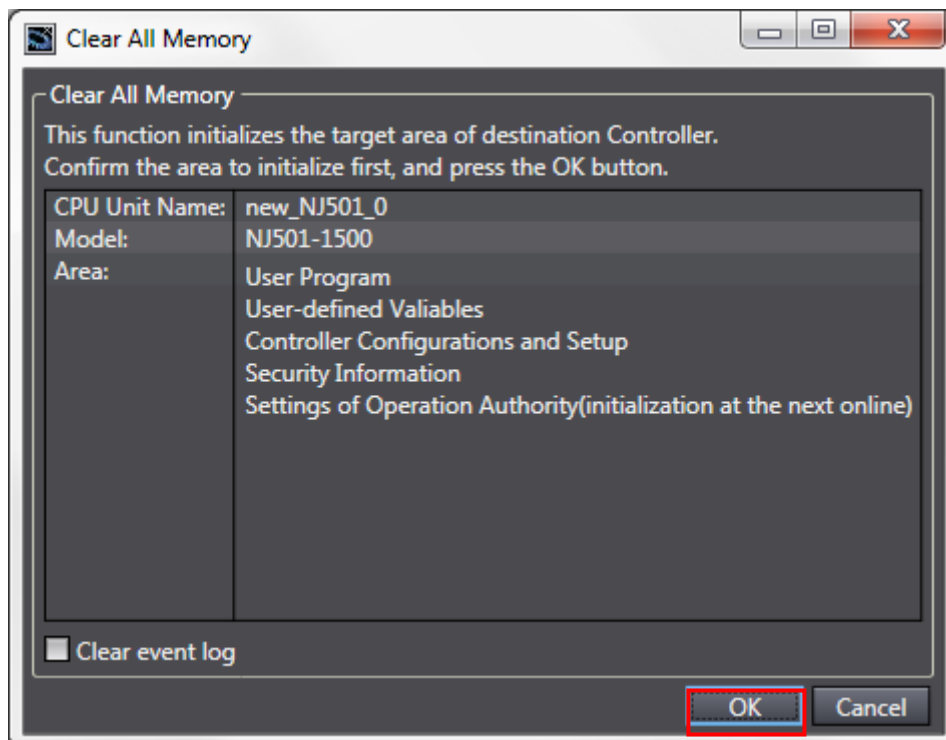

## 8.2. Inverter

For information on how to initialize the Inverter, refer to Initialization Setting of 5-14 Other Functions in the SYSDRIVE MX2 Series Multi-function Compact Inverter (Cat.No. I570).

## 9. Appendix 1 Details of Remote I/O Communication Settings

This section explains the details of the settings necessary to perform remote I/O communications of the DeviceNet that is set in this document.

### 9.1. Global Variable Table

The Controller accesses the remote I/O communication data as global variables. The following are the settings of the global variables. Use the Sysmac Studio to register a global variable table. For details on allocations, refer to 6.2.

Name	Data type	AT	Destination device allocation
DN00_CMD_OUT	BOOL [16]	%3200	Command
DN00_DATA_OUT	WORD	%3201	Rotation Speed Reference
DN00_STA_IN	BOOL [16]	%3300	Status information
DN00_DATA_IN	WORD	%3301	Rotation Speed Monitor



#### Additional Information

Set the AT to the values in memory used for CJ-series Units, which were allocated to the slaves, using the CX-Integrator. With Sysmac Studio, add the prefix "%" to each address to indicate the memory used for CJ-series Units. To allocate a bit address, set the data type to BOOL and set the AT to %3200.00 as shown below.

Name	Data type	AT	Destination device allocation
DN00_OUT_Bit00	BOOL	%3200.00	Bit 00 Output
:			
DN00_OUT_Bit15	BOOL	%3200.15	Bit 15 Output
DN00_IN_Bit00	BOOL	%3300.00	Bit 00 Input
:			
DN00_IN_Bit15	BOOL	%3300.15	Bit 15 Input

Do not specify the same area for the bit and word addresses as shown below.

Name	Data type	AT	Destination device allocation
<del>DN00_OUT_Bit00</del>	<del>BOOL</del>	<del>%3200.00</del>	<del>Bit 00 Output</del>
<del>:</del>			
<del>DN00_OUT_Bit15</del>	<del>BOOL</del>	<del>%3200.15</del>	<del>Bit 15 Output</del>
<del>DN00_OUT</del>	<del>WORD</del>	<del>%3200</del>	<del>Bit 00 to 15 Output (2 bytes)</del>



#### Additional Information

With the Sysmac Studio, the data type is expressed as ARRAY[0..2] OF WORD when an array is specified for a data type. However, a data type of an array is simplified in this document. (e.g. WORD[3]).

It is possible to set either of the following to specify an array for a data type with the Sysmac Studio.

- ARRAY[0..2] OF WORD
- WORD [3]

In the example above, 3 WORD array elements are secured.

## 10. Appendix 2 Setting Procedure without the Configuration Files

This section describes the procedure for setting up the Controller using the software without using the configuration files (Procedure for setting the parameters from the beginning). It also describes the procedure for changing the parameters of the configuration files.

### 10.1. Overview of Setting Procedure without the Configuration Files

The following is the relationship of processes to perform remote I/O communications using the "procedures for setting parameters from beginning".

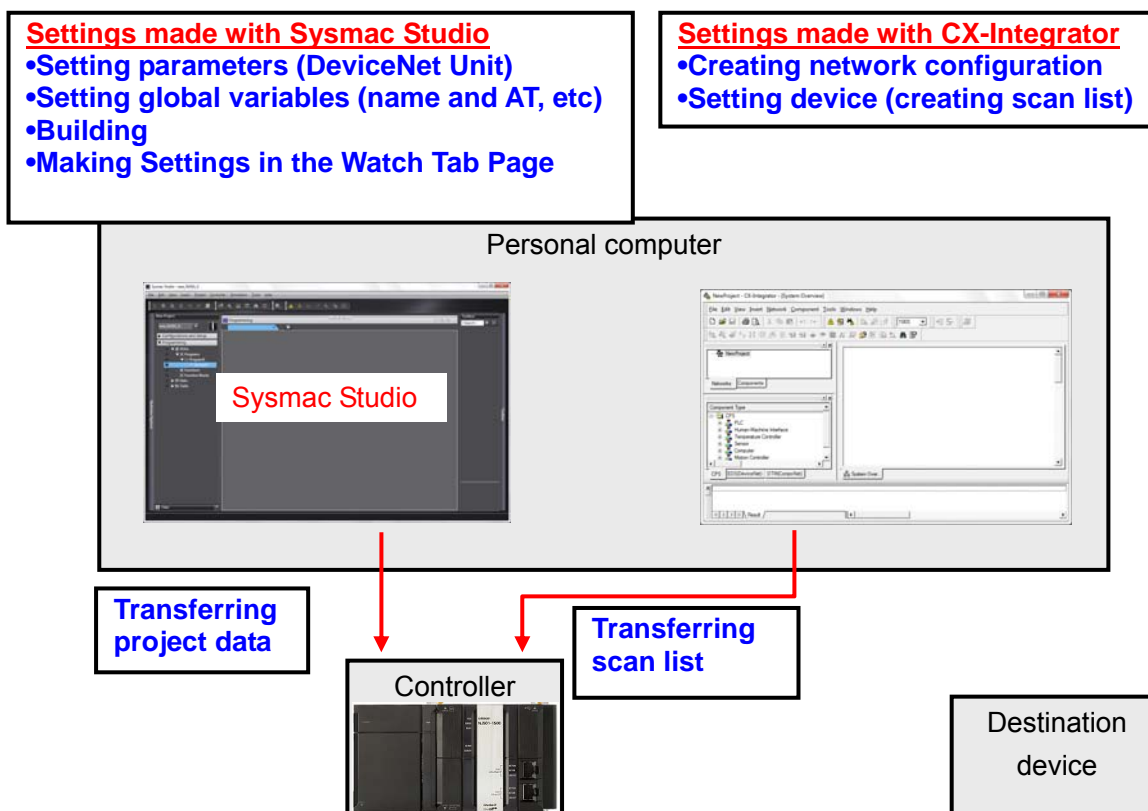

**10.2. Work Flow of the "Procedure for Setting the Parameters from the Beginning"**

The following is the procedure for making connection settings for remote I/O communications of the DeviceNet using the "procedures for setting parameters from beginning".

This section describes the detailed procedures for "10.3 Setting up the Controller without the Configuration Files" and "10.4 Setting up the Network by CX-Integrator" (in red frames below) to make settings with software without using "configuration files".

For details on the procedures for 7.3 Setting up the Inverter, 7.4.1 Hardware Settings for the DeviceNet Unit, and 7.6 Checking the Connection Status, refer to Section 7 because they are the same as for the "procedures for using configuration files".

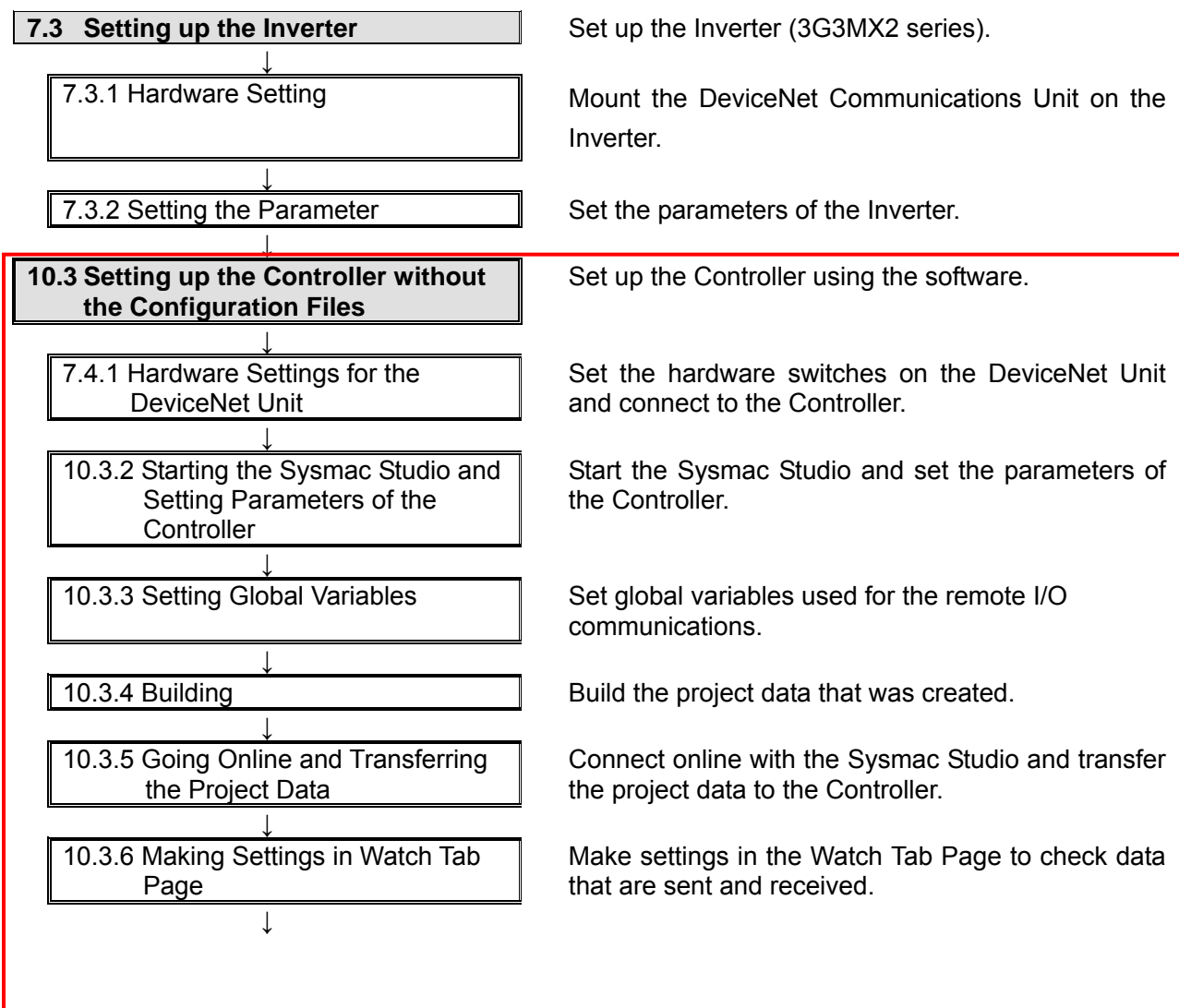

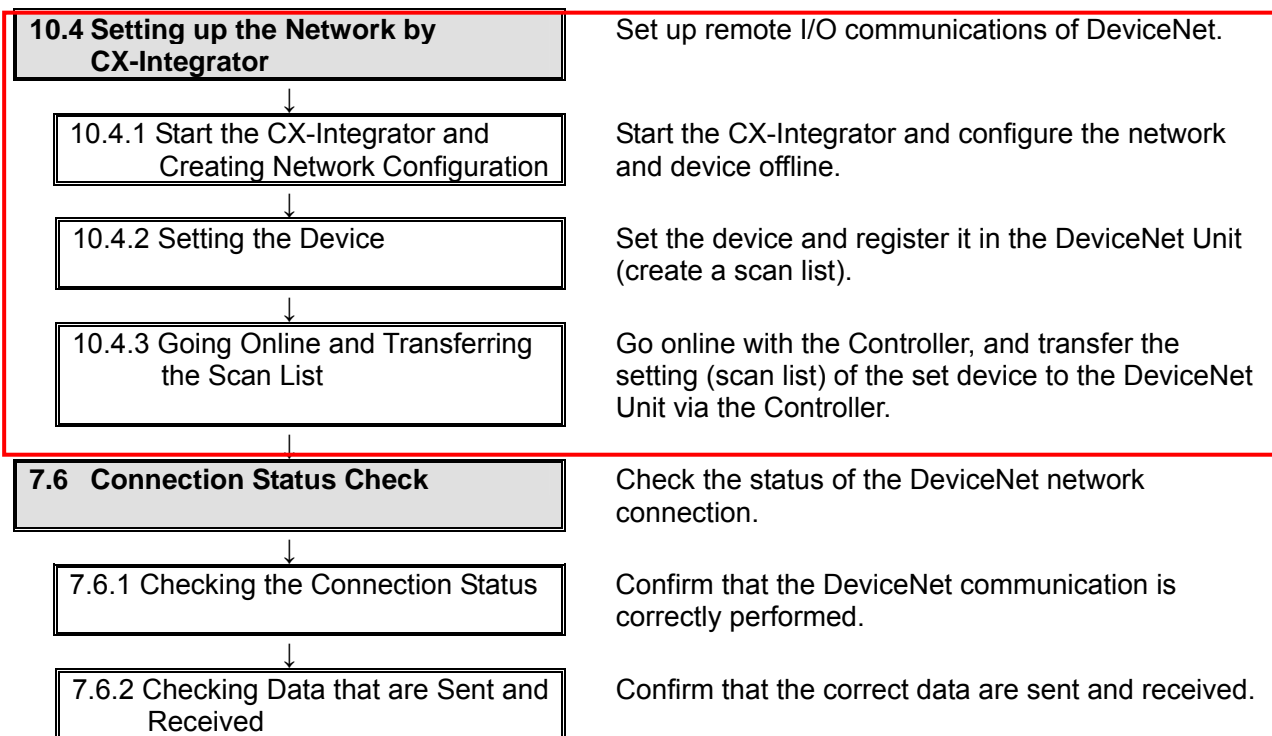

**10.3. Setting up the Controller without the Configuration Files**

Set up the Controller using the software.

**10.3.2. Starting the Sysmac Studio and Setting the Parameters of the Controller**

Start the Sysmac Studio and set the parameters of the Controller.

- 1 Start the Sysmac Studio.  
Click the **New Project** Button.

\*If a dialog box is displayed at start confirming the access right, select an option to start.



- 2 The Project Properties Dialog Box is displayed. Click the **Create** Button.

\*In this document, New Project is set as the project name.

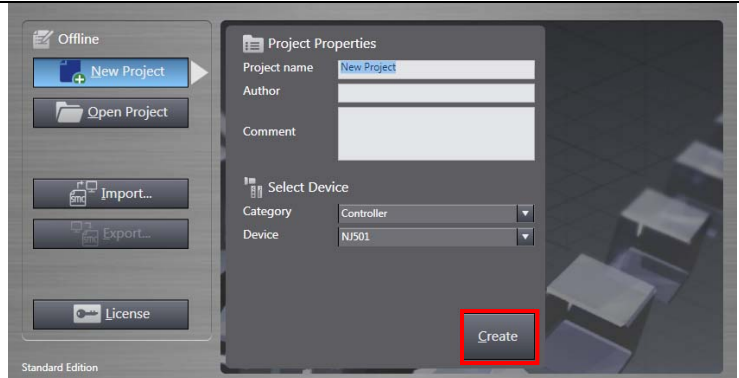

- 3 The New Project Pane is displayed.  
The left pane is called Multiview Explorer, the right pane is called Toolbox and the middle pane is called Edit Pane.

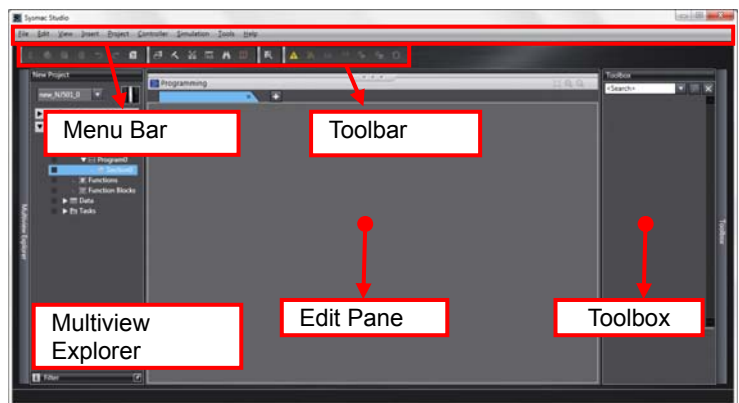

- 4 Double-click **CPU/Expansion Racks** under Configurations and Setup in the Multiview Explorer.

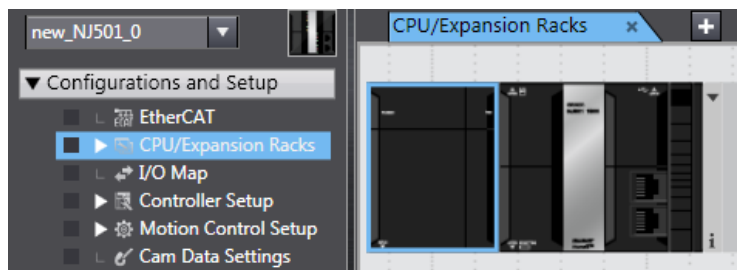

5 Select **Communications** under Category in the Toolbox.

Select CJ1W-DRM21.

Right-click the **CJ1W-DRM21**.  
Select Insert from the menu that is displayed.

CJ1W-DRM21 is displayed as shown in the figure on the right.

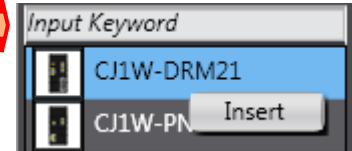
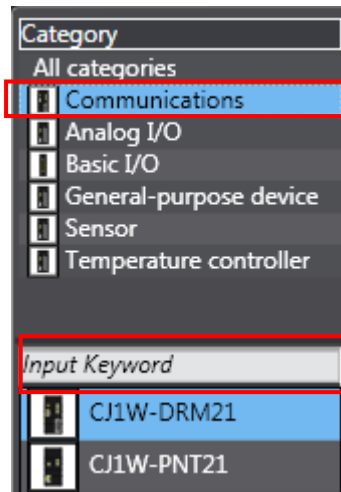

6 Enter 0 in the Unit No. Field.

Item name	Value
Device name	J01
Model name	CJ1W-DRM21
Product name	DeviceNet Master Unit
Specifications	Master/slave, 32000 poi...
Rack No.	0
Slot No.	0
Unit No.	0
Special Unit Settings	Settings
	Edit Special Unit Settings



### 10.3.3. Setting Global Variables

Set global variables used for the remote I/O communications.

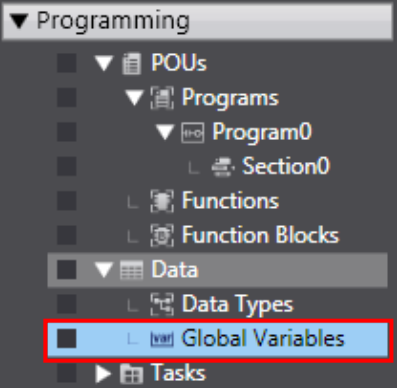
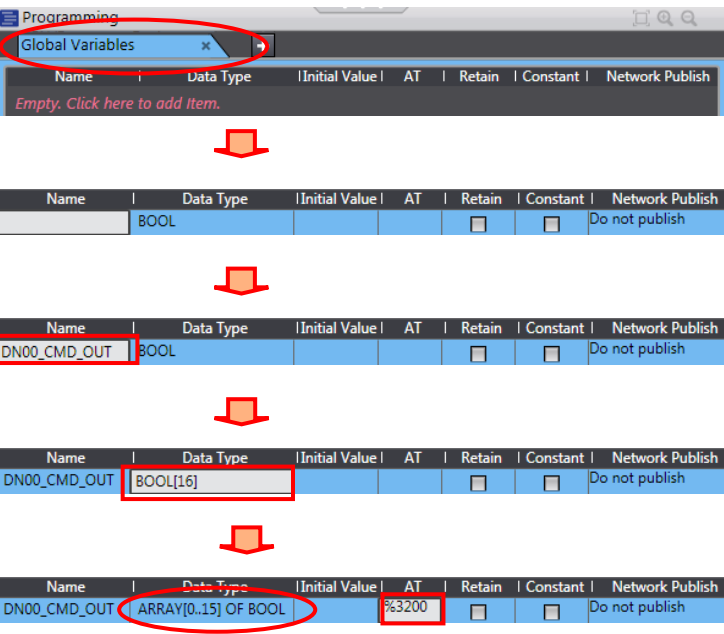
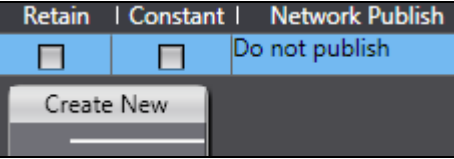
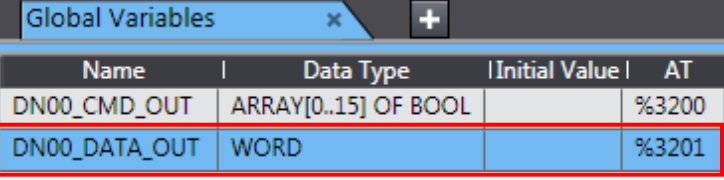
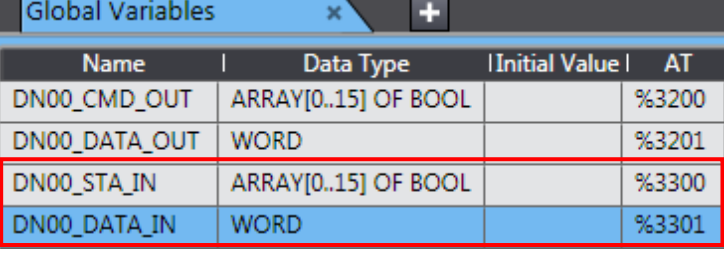
<p>1</p>	<p>Double-click <b>Global variables</b> under <b>Programming - Data</b> in the Multiview Explorer.</p>																																																																							
<p>2</p>	<p>The Global Variables Tab is displayed in the Multiview Explorer. Click a Name Cell to enter a new variable.</p> <p>Enter <i>DN00_CMD_OUT</i> in the Name Column.</p> <p>Enter <i>BOOL[16]</i> in the Data Type Column.                  *When the data have been entered, <i>ARRAY[0..15] OF BOOL</i> is displayed as shown on the right figure.</p> <p>Enter <i>%3200</i> in the AT Column.</p>	 <table border="1" data-bbox="715 698 1442 815"> <thead> <tr> <th>Name</th> <th>Data Type</th> <th>Initial Value</th> <th>AT</th> <th>Retain</th> <th>Constant</th> <th>Network Publish</th> </tr> </thead> <tbody> <tr> <td>Empty. Click here to add item.</td> <td></td> <td></td> <td></td> <td></td> <td></td> <td></td> </tr> </tbody> </table> <table border="1" data-bbox="715 887 1442 936"> <thead> <tr> <th>Name</th> <th>Data Type</th> <th>Initial Value</th> <th>AT</th> <th>Retain</th> <th>Constant</th> <th>Network Publish</th> </tr> </thead> <tbody> <tr> <td></td> <td>BOOL</td> <td></td> <td></td> <td><input type="checkbox"/></td> <td><input type="checkbox"/></td> <td>Do not publish</td> </tr> </tbody> </table> <table border="1" data-bbox="715 1016 1442 1066"> <thead> <tr> <th>Name</th> <th>Data Type</th> <th>Initial Value</th> <th>AT</th> <th>Retain</th> <th>Constant</th> <th>Network Publish</th> </tr> </thead> <tbody> <tr> <td>DN00_CMD_OUT</td> <td>BOOL</td> <td></td> <td></td> <td><input type="checkbox"/></td> <td><input type="checkbox"/></td> <td>Do not publish</td> </tr> </tbody> </table> <table border="1" data-bbox="715 1146 1442 1196"> <thead> <tr> <th>Name</th> <th>Data Type</th> <th>Initial Value</th> <th>AT</th> <th>Retain</th> <th>Constant</th> <th>Network Publish</th> </tr> </thead> <tbody> <tr> <td>DN00_CMD_OUT</td> <td>BOOL[16]</td> <td></td> <td></td> <td><input type="checkbox"/></td> <td><input type="checkbox"/></td> <td>Do not publish</td> </tr> </tbody> </table> <table border="1" data-bbox="715 1276 1442 1326"> <thead> <tr> <th>Name</th> <th>Data Type</th> <th>Initial Value</th> <th>AT</th> <th>Retain</th> <th>Constant</th> <th>Network Publish</th> </tr> </thead> <tbody> <tr> <td>DN00_CMD_OUT</td> <td>ARRAY[0..15] OF BOOL</td> <td></td> <td>%3200</td> <td><input type="checkbox"/></td> <td><input type="checkbox"/></td> <td>Do not publish</td> </tr> </tbody> </table>	Name	Data Type	Initial Value	AT	Retain	Constant	Network Publish	Empty. Click here to add item.							Name	Data Type	Initial Value	AT	Retain	Constant	Network Publish		BOOL			<input type="checkbox"/>	<input type="checkbox"/>	Do not publish	Name	Data Type	Initial Value	AT	Retain	Constant	Network Publish	DN00_CMD_OUT	BOOL			<input type="checkbox"/>	<input type="checkbox"/>	Do not publish	Name	Data Type	Initial Value	AT	Retain	Constant	Network Publish	DN00_CMD_OUT	BOOL[16]			<input type="checkbox"/>	<input type="checkbox"/>	Do not publish	Name	Data Type	Initial Value	AT	Retain	Constant	Network Publish	DN00_CMD_OUT	ARRAY[0..15] OF BOOL		%3200	<input type="checkbox"/>	<input type="checkbox"/>	Do not publish
Name	Data Type	Initial Value	AT	Retain	Constant	Network Publish																																																																		
Empty. Click here to add item.																																																																								
Name	Data Type	Initial Value	AT	Retain	Constant	Network Publish																																																																		
	BOOL			<input type="checkbox"/>	<input type="checkbox"/>	Do not publish																																																																		
Name	Data Type	Initial Value	AT	Retain	Constant	Network Publish																																																																		
DN00_CMD_OUT	BOOL			<input type="checkbox"/>	<input type="checkbox"/>	Do not publish																																																																		
Name	Data Type	Initial Value	AT	Retain	Constant	Network Publish																																																																		
DN00_CMD_OUT	BOOL[16]			<input type="checkbox"/>	<input type="checkbox"/>	Do not publish																																																																		
Name	Data Type	Initial Value	AT	Retain	Constant	Network Publish																																																																		
DN00_CMD_OUT	ARRAY[0..15] OF BOOL		%3200	<input type="checkbox"/>	<input type="checkbox"/>	Do not publish																																																																		
<p>3</p>	<p>After entering values, right-click and select <b>Create New</b> from the menu.</p>																																																																							
<p>4</p>	<p>Enter the following data in the new cells in the same way as step 2.</p> <ul style="list-style-type: none"> <li>Name: <i>DN00_DATA_OUT</i></li> <li>Data Type: <i>WORD</i></li> <li>AT: <i>%3201</i></li> </ul>	 <table border="1" data-bbox="715 1518 1442 1697"> <thead> <tr> <th>Name</th> <th>Data Type</th> <th>Initial Value</th> <th>AT</th> </tr> </thead> <tbody> <tr> <td>DN00_CMD_OUT</td> <td>ARRAY[0..15] OF BOOL</td> <td></td> <td>%3200</td> </tr> <tr> <td>DN00_DATA_OUT</td> <td>WORD</td> <td></td> <td>%3201</td> </tr> </tbody> </table>	Name	Data Type	Initial Value	AT	DN00_CMD_OUT	ARRAY[0..15] OF BOOL		%3200	DN00_DATA_OUT	WORD		%3201																																																										
Name	Data Type	Initial Value	AT																																																																					
DN00_CMD_OUT	ARRAY[0..15] OF BOOL		%3200																																																																					
DN00_DATA_OUT	WORD		%3201																																																																					
<p>5</p>	<p>Enter the following data in the new cells in the same way as steps 2 and 3.</p> <ul style="list-style-type: none"> <li>Name: <i>DN00_STA_IN</i></li> <li>Data type: <i>BOOL[16]</i></li> <li>AT: <i>%3300</i></li> <li>Name: <i>DN00_DATA_IN</i></li> <li>Data Type: <i>WORD</i></li> <li>AT: <i>%3301</i></li> </ul>	 <table border="1" data-bbox="715 1720 1442 1973"> <thead> <tr> <th>Name</th> <th>Data Type</th> <th>Initial Value</th> <th>AT</th> </tr> </thead> <tbody> <tr> <td>DN00_CMD_OUT</td> <td>ARRAY[0..15] OF BOOL</td> <td></td> <td>%3200</td> </tr> <tr> <td>DN00_DATA_OUT</td> <td>WORD</td> <td></td> <td>%3201</td> </tr> <tr> <td>DN00_STA_IN</td> <td>ARRAY[0..15] OF BOOL</td> <td></td> <td>%3300</td> </tr> <tr> <td>DN00_DATA_IN</td> <td>WORD</td> <td></td> <td>%3301</td> </tr> </tbody> </table>	Name	Data Type	Initial Value	AT	DN00_CMD_OUT	ARRAY[0..15] OF BOOL		%3200	DN00_DATA_OUT	WORD		%3201	DN00_STA_IN	ARRAY[0..15] OF BOOL		%3300	DN00_DATA_IN	WORD		%3301																																																		
Name	Data Type	Initial Value	AT																																																																					
DN00_CMD_OUT	ARRAY[0..15] OF BOOL		%3200																																																																					
DN00_DATA_OUT	WORD		%3201																																																																					
DN00_STA_IN	ARRAY[0..15] OF BOOL		%3300																																																																					
DN00_DATA_IN	WORD		%3301																																																																					

### 10.3.4. Building

Build the project data that was created.

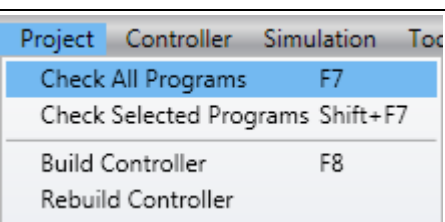
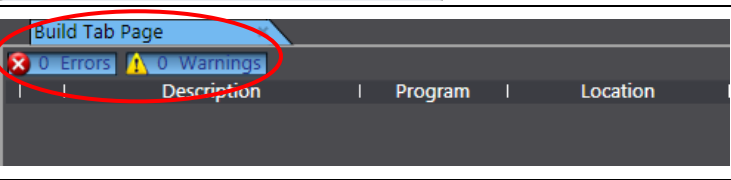
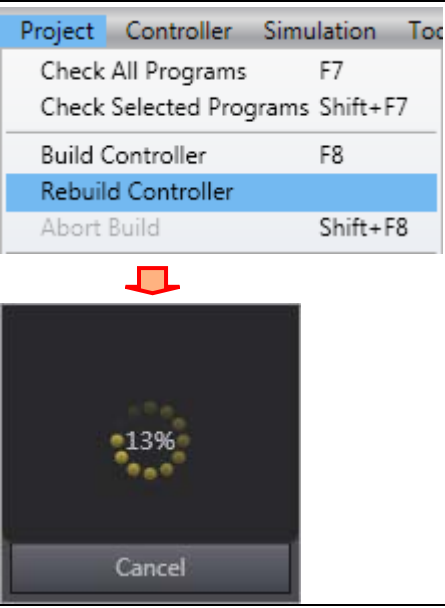
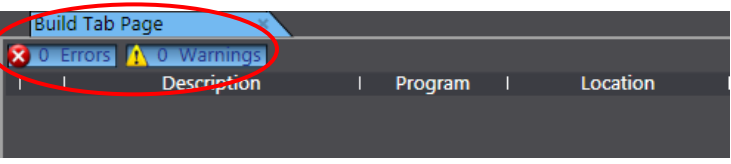
<p>1</p>	<p>Select <b>Check All Programs</b> from the Project Menu.</p>	 <p>The screenshot shows a menu with the following items: 'Check All Programs' (F7), 'Check Selected Programs' (Shift+F7), 'Build Controller' (F8), and 'Rebuild Controller'. The 'Check All Programs' option is highlighted in blue.</p>
<p>2</p>	<p>The Build Tab Page is displayed in the Edit Pane. Confirm that both error and warning are 0.</p>	 <p>The screenshot shows a 'Build Tab Page' with a status bar indicating '0 Errors' and '0 Warnings'. A red circle highlights these counts. Below the status bar is a table with columns for 'Description', 'Program', and 'Location'.</p>
<p>3</p>	<p>Select <b>Rebuild Controller</b> from the Project Menu.</p> <p>A screen is displayed indicating the conversion is being performed.</p>	 <p>The top part of the screenshot shows the 'Project' menu with 'Rebuild Controller' (Shift+F8) highlighted. Below it, a red arrow points to a progress dialog box showing a circular progress indicator at 13% and a 'Cancel' button.</p>
<p>4</p>	<p>Confirm that both error and warning are 0 in the Build Tab Page.</p>	 <p>The screenshot shows the 'Build Tab Page' again, with '0 Errors' and '0 Warnings' highlighted by a red circle, indicating the build process is complete.</p>

**10.3.5. Going Online and Transferring the Project Data**

Connect online with the Sysmac Studio and transfer the project data to the Controller. After transfer, reset the Controller.

**⚠ WARNING**

Always confirm safety at the destination node before you transfer a user program, configuration data, setup data, device variables, or values in memory used for CJ-series Units from the Sysmac Studio.

The devices or machines may perform unexpected operation regardless of the operating mode of the CPU Unit.



**⚠ Caution**

Always confirm safety before you reset the Controller or any components.



**1** Select **Communications Setup** from the Controller Menu.

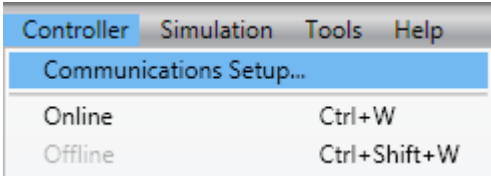

**2** The Communications Setup Dialog Box is displayed. Select the *Direct connection via USB* in the Connection Type Field.

Click the **OK** Button.

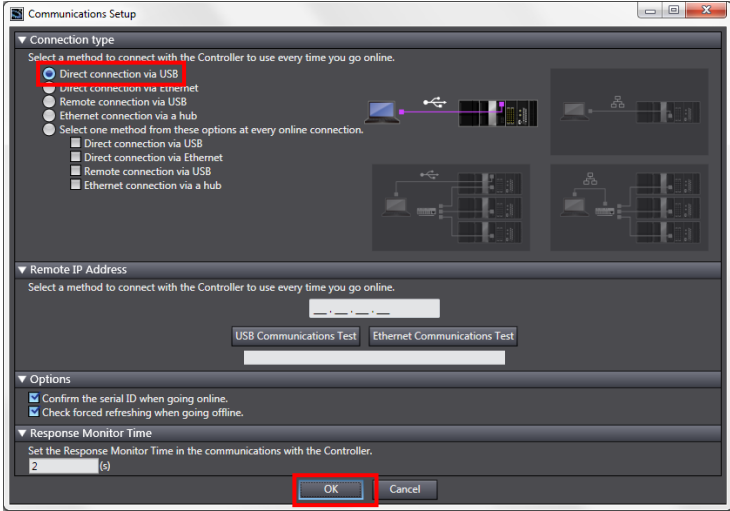

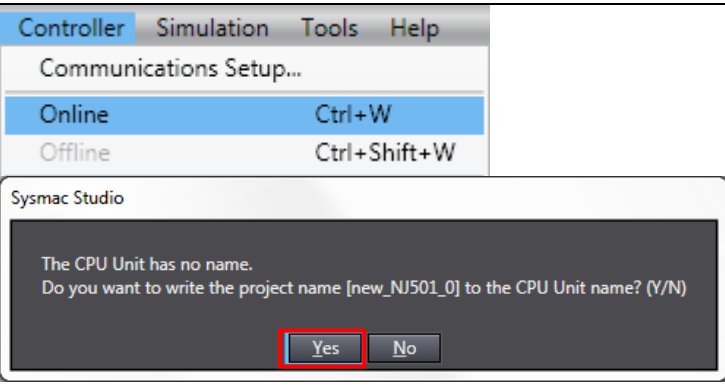
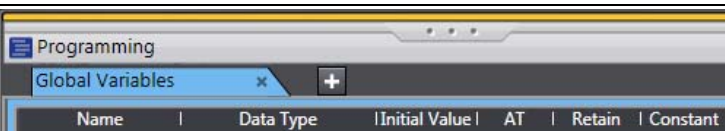
<p>3</p>	<p>Select <b>Online</b> from the Controller Menu.</p> <p>A confirmation dialog is displayed. Click the <b>Yes</b> Button.</p> <p>*A displayed dialog depends on the status of the Controller used. Select the <b>Yes</b> Button or other button to proceed with the processing.</p>	 <p>The screenshot shows the 'Controller' menu with 'Online' selected. Below it is a 'Sysmac Studio' dialog box with the text: 'The CPU Unit has no name. Do you want to write the project name [new_NJ501_0] to the CPU Unit name? (Y/N)'. The 'Yes' button is highlighted with a red box.</p>
<p>4</p>	<p>When an online connection is established, a yellow bar is displayed on the top of the Edit Pane.</p>	 <p>The screenshot shows the 'Global Variables' pane in Sysmac Studio. A yellow bar is visible at the top of the pane, indicating an online connection.</p>



## Additional Information

For details on the online connections to a Controller, refer to *Section 5 Going Online with a Controller* in the *Sysmac Studio Version 1 Operation Manual (Cat. No. W504)*.

- 5 Select **Synchronization** from the Controller Menu.

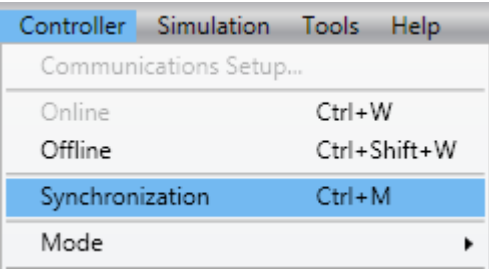

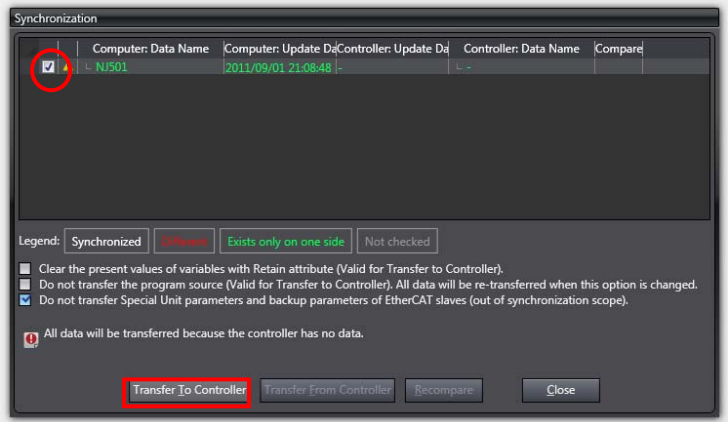
  
- 6 The Synchronization Dialog Box is displayed. Confirm that the data to transfer (NJ501 in the right figure) is selected. Then, click the **Transfer to Controller** Button.

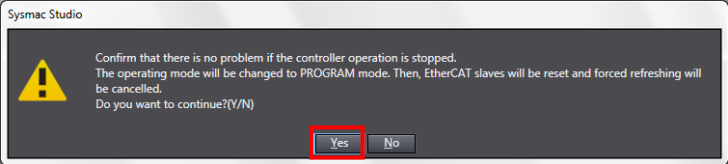
  
- 7 A confirmation dialog is displayed. Click the **Yes** Button.



↓

A screen stating "Synchronizing" is displayed.



↓

A confirmation dialog box is displayed. Click the **No** Button.

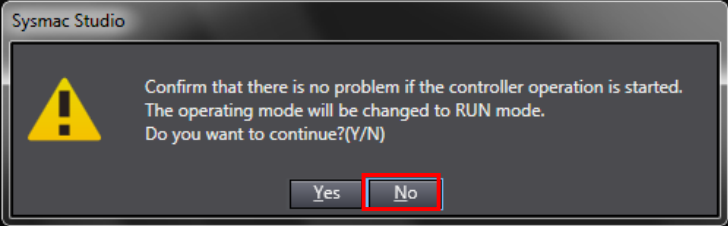

8 Confirm that the synchronized data is displayed with the color specified by “Synchronized” color, and that a message is displayed stating "The synchronization process successfully finished".  
If there is no problem, click the **Close** Button.

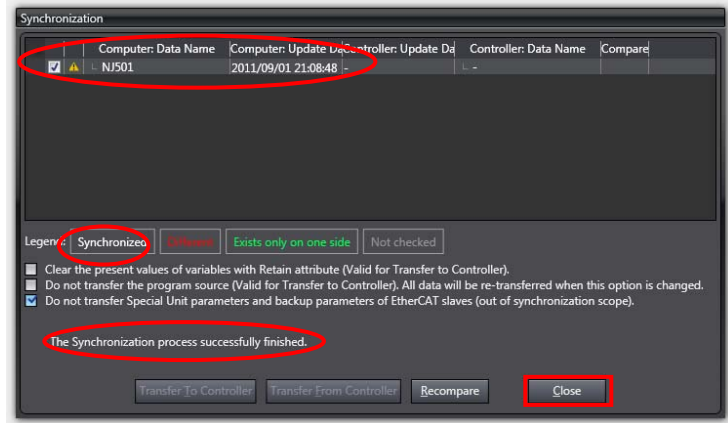

\*If the synchronization fails, check the wiring and repeat the procedure described in this section.

9 Select **Reset Controller** from the Controller Menu.

\*When Mode is set to RUN Mode, Reset Controller cannot be selected. In this case, select **Mode - PROGRAM Mode** from the Controller Menu to change to PROGRAM mode and perform the procedure in this step.

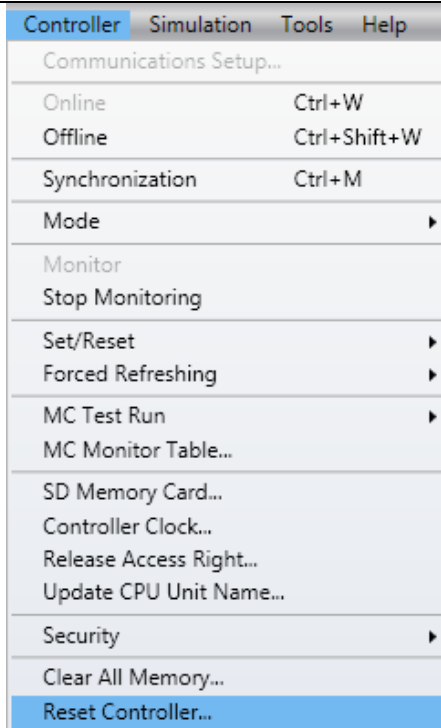

10 A confirmation dialog box is displayed several times. Click the **Yes** Button.

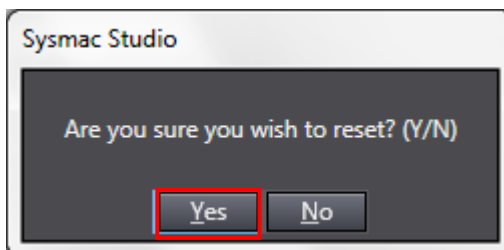
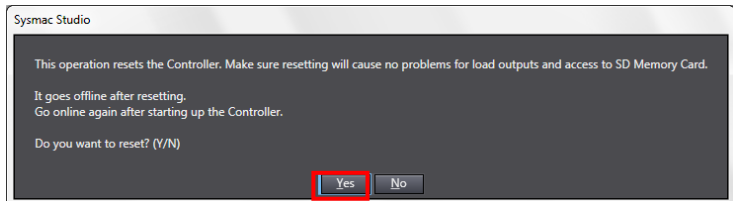

- 11 The controller is reset, and Sysmac Studio goes offline. The yellow bar on the top of the Edit Pane disappears. Use steps 1 to 4 to go online.

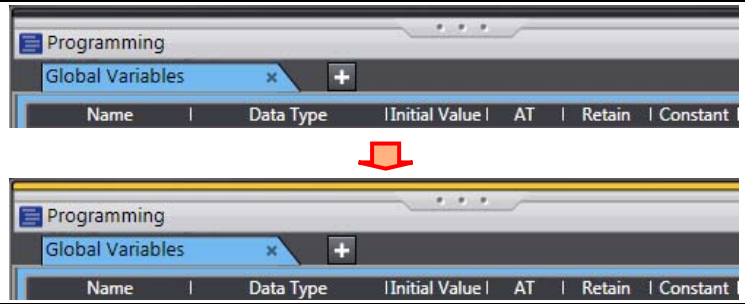

### 10.3.6. Making Settings in the Watch Tab Page

Make settings in the Watch Tab Page to check data that are sent and received.

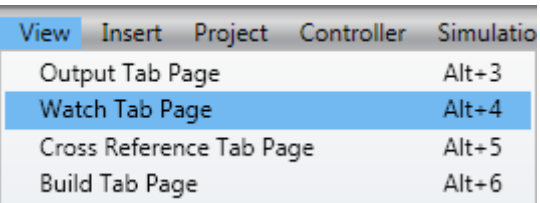
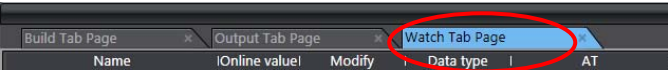
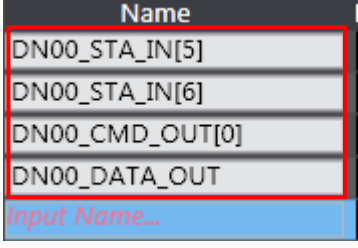
<p>1 Select <b>Watch Tab Page</b> from the View Menu.</p>	
<p>2 The Watch Tab Page is displayed in the lower section of the Edit Pane.</p>	
<p>3 Enter the following names to monitor in the Name Cell on the Watch Tab Page. To enter a new name, click a cell stating Input Name.</p> <p>DN00_STA_IN[5]          DN00_STA_IN[6]          DN00_CMD_OUT[0]          DN00_DATA_OUT</p> <p>*The settings are used in 7.6.2.          Checking Data That Are Sent and Received.</p>	



### 10.4. Setting up the Network by CX-Integrator

Set up remote I/O communications of the DeviceNet by CX-Integrator.

#### 10.4.1. Starting CX-Integrator and Configuring the Network

Start the CX-Integrator and configure the network and device offline.



#### Precautions for Correct Use

Please confirm that the DeviceNet cable has been connected before proceeding to the following procedures.

If it is not connected, turn OFF the power to the devices, and then connect the DeviceNet cable.

<p>1 Start the CX-Integrator.</p> <p>*If the Component List Window is not displayed, select <b>Windows - Component List Window</b> from the View Menu.</p> <p>Component List Window</p>																	
<p>2 Select <b>Network</b> from the Insert Menu of the CX-Integrator.</p>																	
<p>3 Select <b>DeviceNet</b> and click the <b>Next</b> Button.</p>	<table border="1" data-bbox="989 1590 1404 1904"> <thead> <tr> <th>Name</th> <th>Description</th> </tr> </thead> <tbody> <tr> <td>CompoNet</td> <td>Fieldbus Network(CompoNet)</td> </tr> <tr> <td>CompoWayF</td> <td>Serial connection(for compor</td> </tr> <tr> <td>ControllerLink</td> <td>PLC level Network(CLK)</td> </tr> <tr style="border: 2px solid red;"> <td>DeviceNet</td> <td>Fieldbus Network(DeviceNet)</td> </tr> <tr> <td>Ethernet</td> <td>Ethernet(FINS)</td> </tr> <tr> <td>NTLink</td> <td>Serial connection(for display:</td> </tr> <tr> <td>SysmacLink</td> <td>PLC level Network(SLK)</td> </tr> </tbody> </table>	Name	Description	CompoNet	Fieldbus Network(CompoNet)	CompoWayF	Serial connection(for compor	ControllerLink	PLC level Network(CLK)	DeviceNet	Fieldbus Network(DeviceNet)	Ethernet	Ethernet(FINS)	NTLink	Serial connection(for display:	SysmacLink	PLC level Network(SLK)
Name	Description																
CompoNet	Fieldbus Network(CompoNet)																
CompoWayF	Serial connection(for compor																
ControllerLink	PLC level Network(CLK)																
DeviceNet	Fieldbus Network(DeviceNet)																
Ethernet	Ethernet(FINS)																
NTLink	Serial connection(for display:																
SysmacLink	PLC level Network(SLK)																

- 4 Select the *Not Used* Check Box in the Network Address Field and click the **Finish** Button.

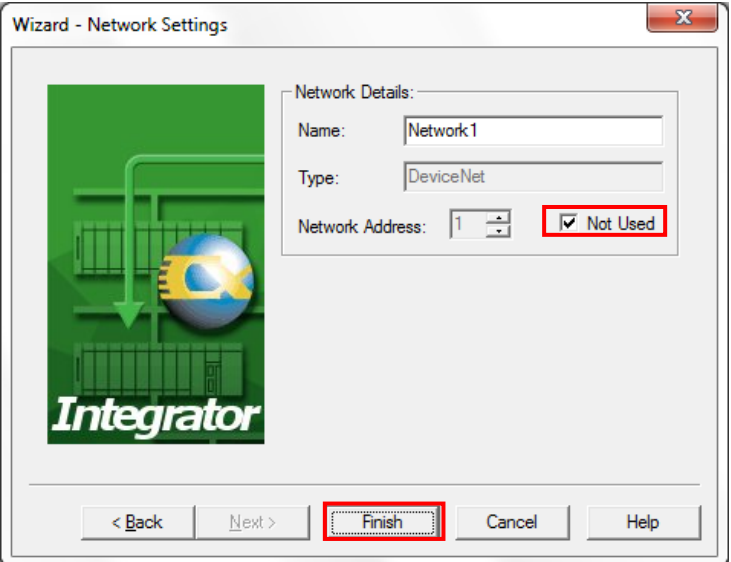
- 5 Register the Master Unit in the Network. Select **Component** from the Insert Menu.

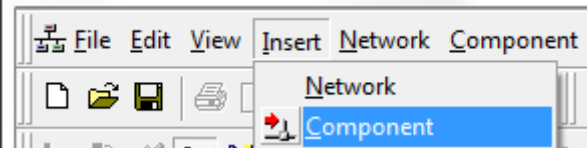

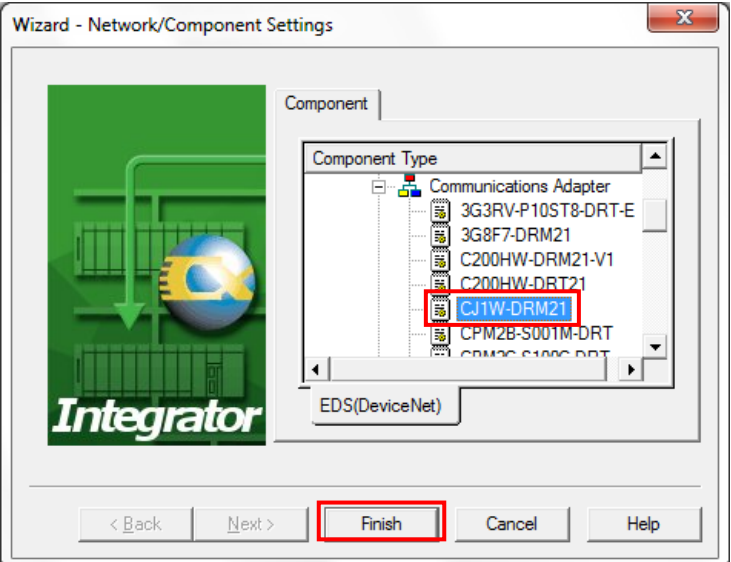
- 6 Select the Master Unit from the component list and click the **Finish** Button. In this example, select **OMRON Corporation Communications Adapter - CJ1W-DRM21**.

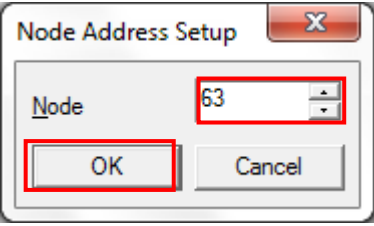

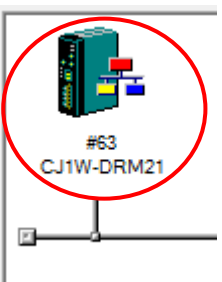
- 7 Enter a node address (63 is set in this example) in the Node Address Setup Dialog Box, and click the **OK** Button.

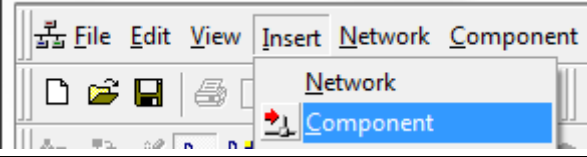

- 8 Confirm that the Master Unit is registered in the Network Configuration Window.

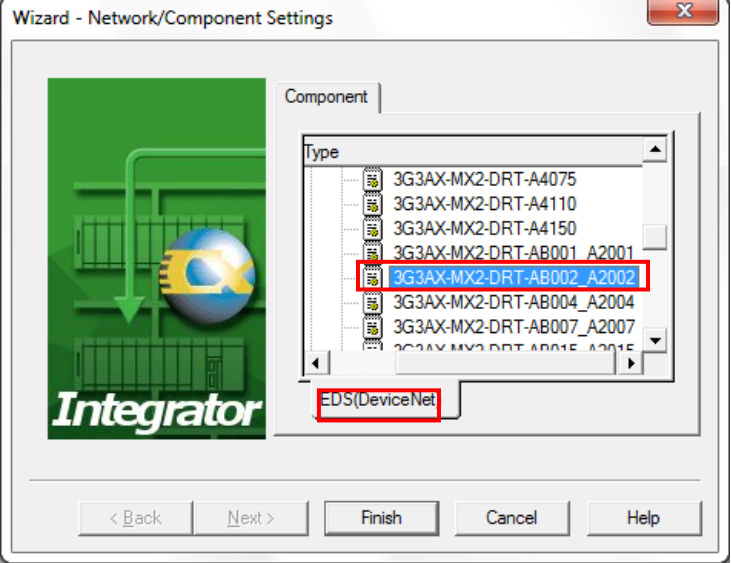

- 9 Register the Inverter (hereinafter referred to as the slave unit) in the network.  
Select **Component** from the Insert Menu.

- 10 Select a slave unit to connect from the component list, and click the **Finish** Button.  
Here, **3G3AX-MX2-DRT-AB002-A2002** is selected.

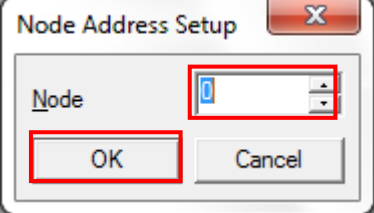

- 11 Enter the node address (0 is set in this example) in the Node Address Setup Dialog Box, and click the **OK** Button.

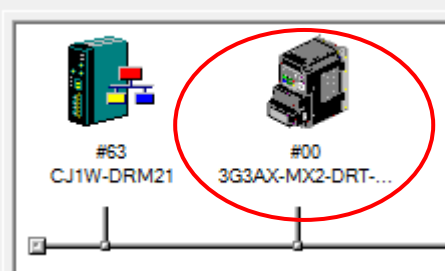
- 12 Confirm that the slave unit is registered in the Network Configuration Window.

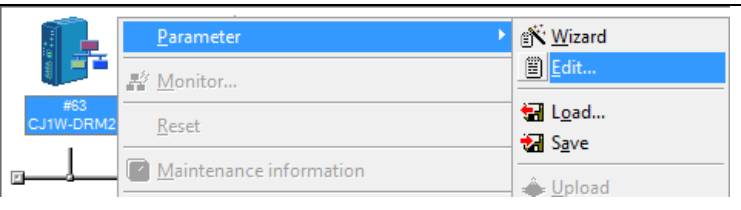
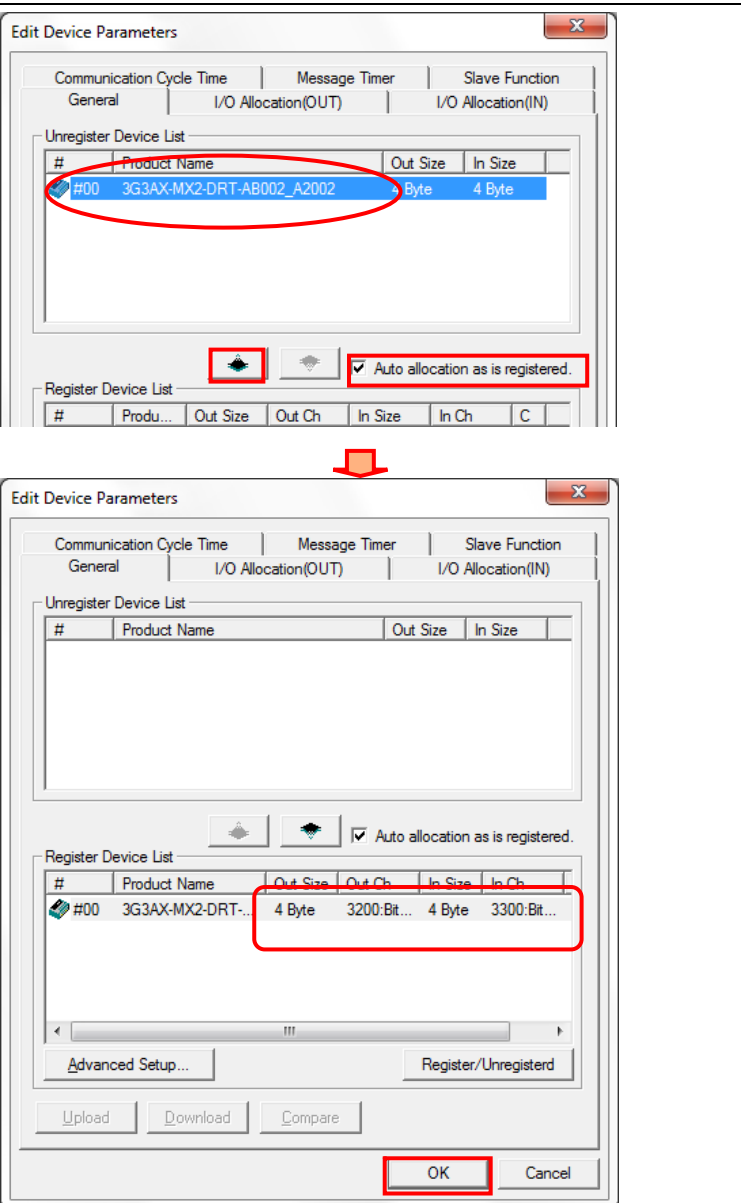
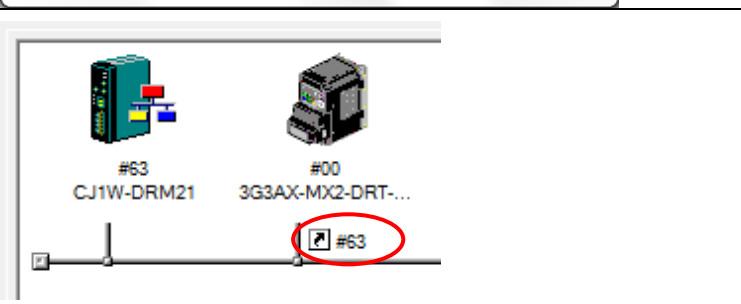

10.4.2. Setting the Device

Set the device and register it in the DeviceNet Unit (create a scan list).

<p>1 Right-click the DeviceNet Unit icon and select <b>Parameter - Edit</b>.</p>	
<p>2 The Edit Device Parameters Dialog Box is displayed. Slave unit (#00) is displayed in the Unregister Device List.</p> <p>Select the <i>Auto allocation as is registered</i> Check Box. Click the ↓ button.</p> <p>Slave unit (#00) is registered in the Unregister Device List.</p> <p>Confirm that the sizes and channels are set as follows, and click the <b>OK</b> Button.</p> <p>OUT Size:4 Byte Out Ch:3200:Bit00 In Size:4 Byte In Ch:3300:Bit00</p>	
<p>3 Confirm that node address #63 is displayed under the slave unit icon on the Network Configuration Window.</p>	

### 10.4.3. Going Online and Transferring the Scan List

Go online with the Controller, and transfer the setting (scan list) of the set device to the DeviceNet Unit via the Controller. When the transfer is completed, remote I/O communications start automatically.

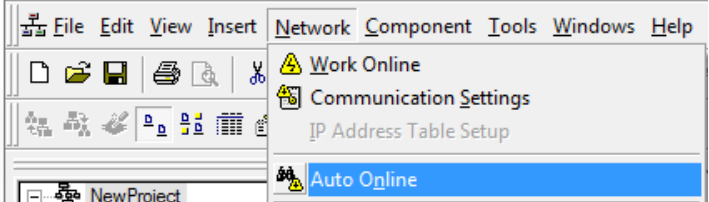
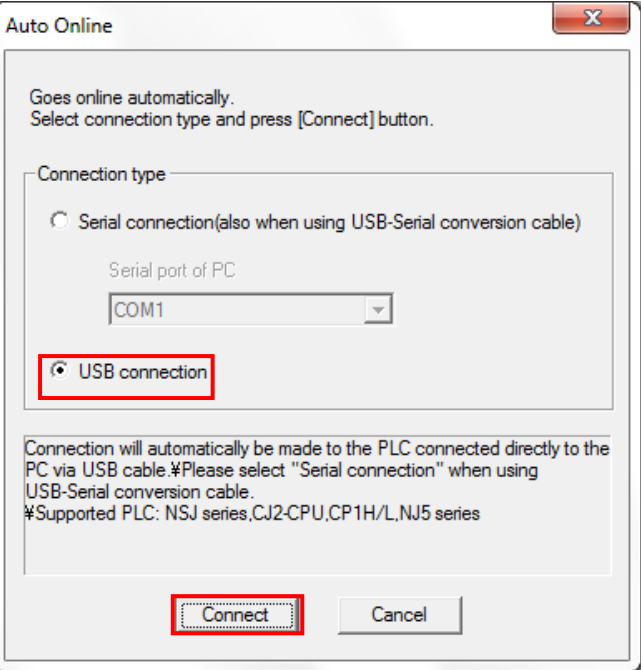
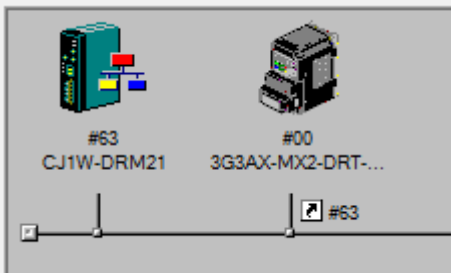
<p>1 Select <b>Auto Online</b> from the Network Menu.</p>	
<p>2 The Auto Online Dialog Box is displayed. Select the <b>USB connection</b> Option in the Connection type Field, and click the <b>Connect</b> Button.</p> <p>A screen is displayed indicating the connection is being established.</p>	
<p>3 After an online connection is established, the background color of the Network Configuration Window changes as shown in the right figure.</p>	



#### Precautions for Correct Use

If an online connection cannot be made to the Controller, check the cable connection. Or, return to step 1 and check the settings such as a connection type and try again.





#### Additional Information

For details on the online connections to a Controller, refer to *Section 2 Basic Operations in the Communications of the CX-Integrator Ver.2.[.] Operation Manual (W446)*.

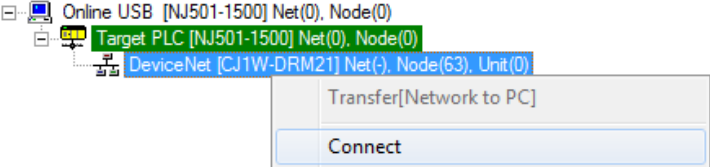
- 4 Right-click DeviceNet in the Online Connection Information Window, and select **Connect**.

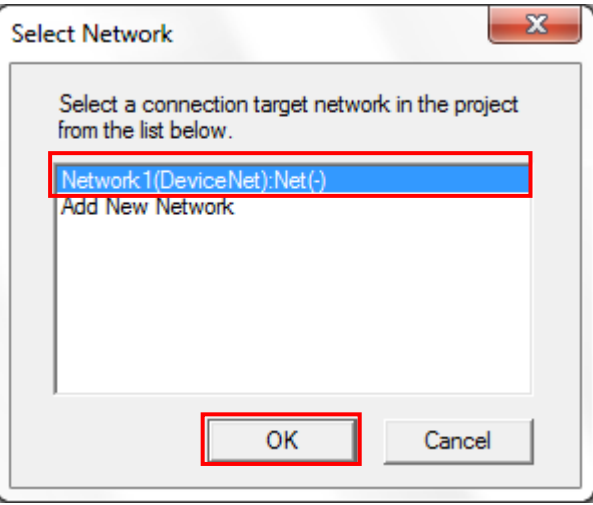

- 5 Select DeviceNet in the Select Network Dialog Box, and click the **OK** Button.

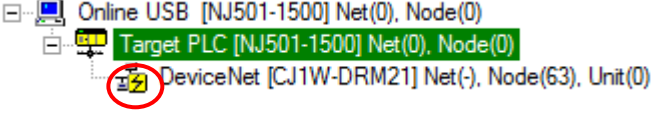
- 6 Confirm that the DeviceNet is in online status (  icon) in the Online Connection Information Window.

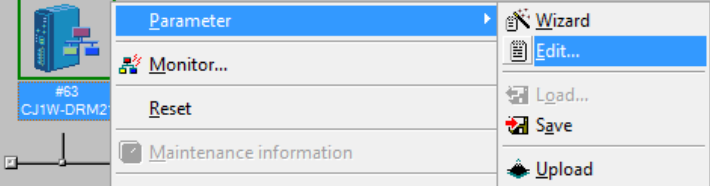

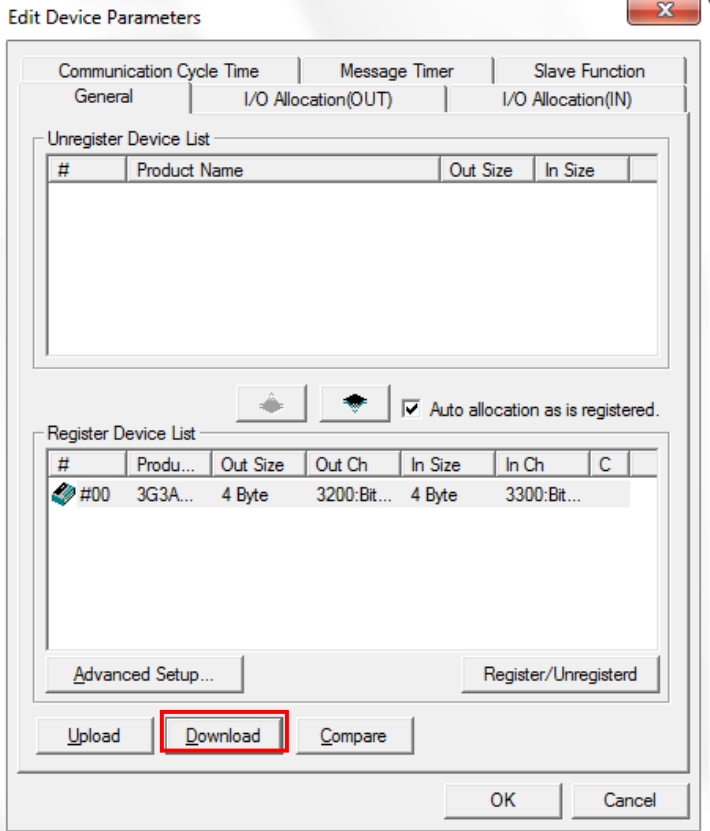
- 7 Right-click CJ1W-DRM21 on the Network Configuration Window, and select **Parameter - Edit**.

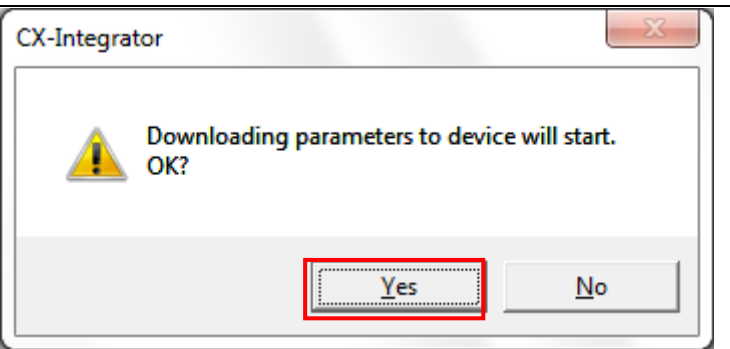
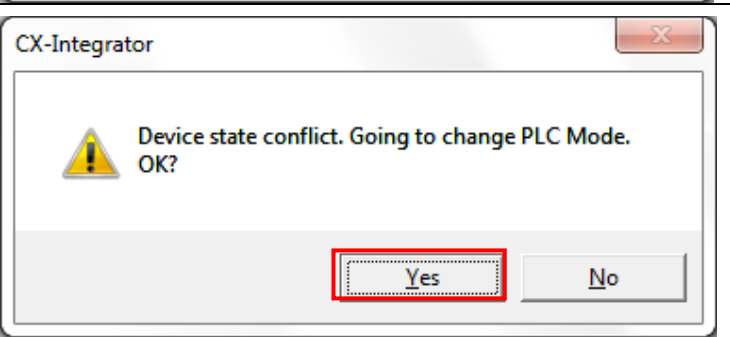
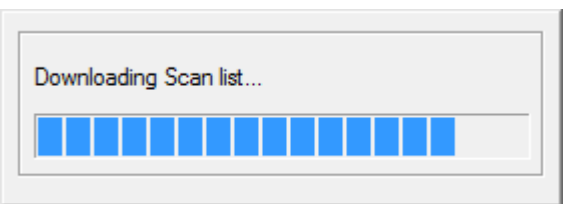
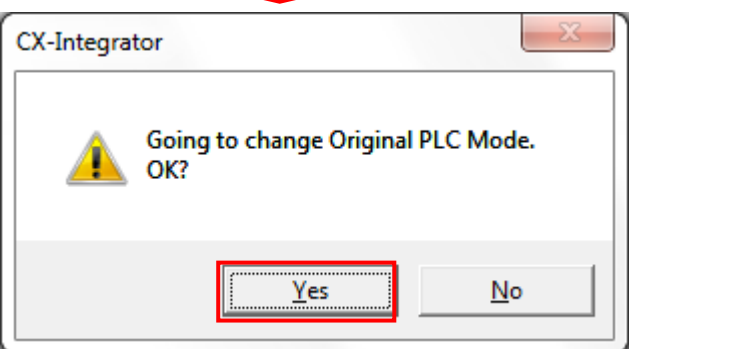
- 8 The Edit Device Parameters Dialog Box is displayed. Click the **Download** Button.

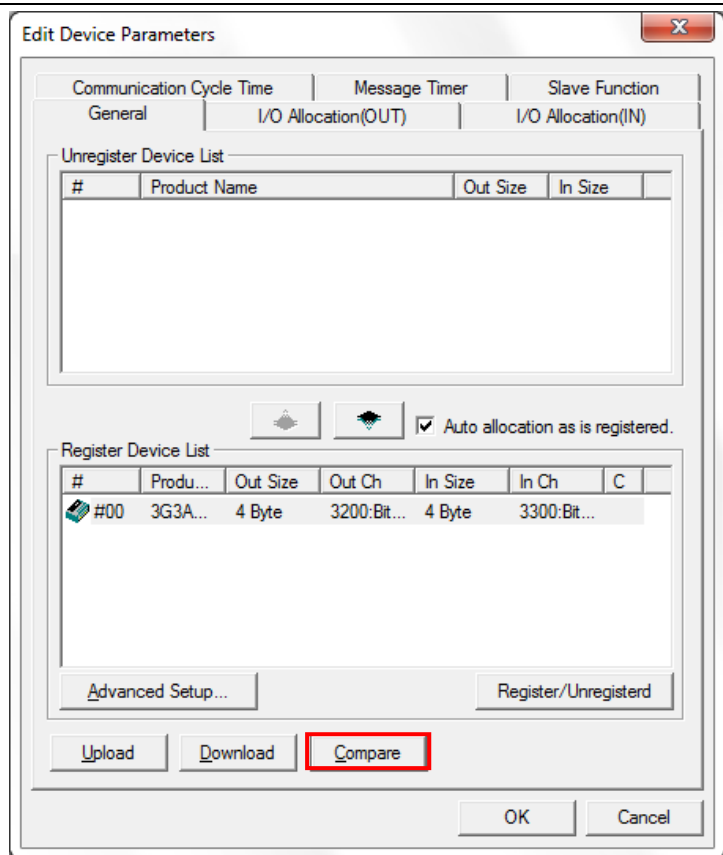

<p>9 A download confirmation dialog box is displayed. Click the <b>Yes</b> Button to download the parameters.</p>	
<p>10 A dialog box is displayed confirming whether to change the mode. Click the <b>Yes</b> Button.</p> <p>A dialog box is displayed indicating downloading is being performed.</p> <p>When downloading is completed, a dialog box is displayed confirming whether to change the mode. Click the <b>Yes</b> Button.</p>	 <p style="text-align: center;">↓</p>  <p style="text-align: center;">↓</p> 

11 The Edit Device Parameters Dialog Box is displayed again. Click the **Compare** Button.



12 A dialog box shown on the right is displayed. Click the **Yes** Button to compare the parameters.

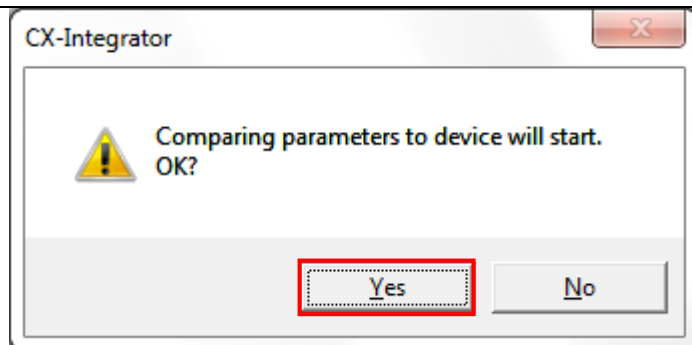

When the comparison is completed, a dialog box shown on the right is displayed. Click the **OK** Button.

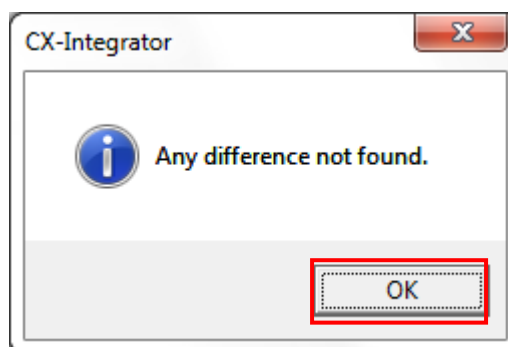

The Edit Device Parameters Dialog Box is displayed again. Click the **OK** Button.

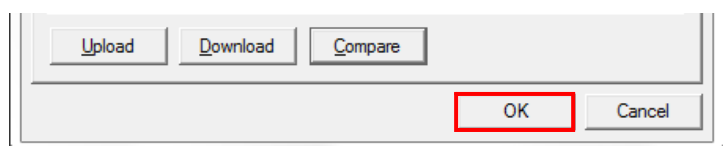



## 11. Revision History

Revision code	Date of revision	Revision reason and revision page
01	Jan. 31, 2013	First edition

**OMRON Corporation Industrial Automation Company**

Tokyo, JAPAN

Contact: [www.ia.omron.com](http://www.ia.omron.com)

**Regional Headquarters**

**OMRON EUROPE B.V.**

Wegalaan 67-69-2132 JD Hoofddorp  
The Netherlands

Tel: (31)2356-81-300/Fax: (31)2356-81-388

**OMRON ELECTRONICS LLC**

One Commerce Drive Schaumburg,  
IL 60173-5302 U.S.A.

Tel: (1) 847-843-7900/Fax: (1) 847-843-7787

**OMRON ASIA PACIFIC PTE. LTD.**

No. 438A Alexandra Road # 05-05/08 (Lobby 2),  
Alexandra Technopark,  
Singapore 119967

Tel: (65) 6835-3011/Fax: (65) 6835-2711

**OMRON (CHINA) CO., LTD.**

Room 2211, Bank of China Tower,  
200 Yin Cheng Zhong Road,  
PuDong New Area, Shanghai, 200120, China

Tel: (86) 21-5037-2222/Fax: (86) 21-5037-2200

Authorized Distributor:

© OMRON Corporation 2013 All Rights Reserved.  
In the interest of product improvement,  
specifications are subject to change without notice.

Cat. No. P522-E1-01

0213(-)