



# Q2A

## Driving Quality

# Installation & Operation Instructions

Item code: Q2A-Axxxx-xxx

400 V class 0.55 kW to 315 kW



# 1 English

## ◆ General Information

Do not use this manual as a replacement for the Technical Manual. The products and specifications given in this manual and the manual contents can change without notice to make the product and manual better. Be sure to always use the most recent version of this manual. Use the manual for the correct installation, wiring, adjustment, and operation of this product. This manual is available for download on our documentation website. Refer to the back page of this manual.

## ◆ Qualifications for the Intended User

This manual is created for electrical specialists and engineers who have experience with AC drive installation, adjustment, repair, inspection, and parts replacement. Persons without technical training, minors, persons with disabilities or mental problems, persons with perception problems, and persons with pacemakers must not use or operate this product.

## ◆ Safety

Read the safety guidelines carefully before installing, wiring, or operating this product.

### ■ Explanation of Signal Words

**⚠ DANGER** Identifies a hazardous situation, which, if not avoided, will cause death or serious injury.

**⚠ WARNING** Identifies a hazardous situation, which, if not avoided, can cause death or serious injury.

**⚠ CAUTION** Identifies a hazardous situation, which, if not avoided, can cause minor or moderate injury.

**NOTICE** Identifies a property damage message.

### ■ General Safety Instructions

Omron supplies electronic components manufactured by Yaskawa for a variety of industrial applications. The selection and application of Q2 products is the responsibility of the designer of the equipment or the customer that assembles the final product. Omron/Yaskawa are not responsible for how our products are incorporated into the final system design. In all cases, Q2 products should not be incorporated into a product or design as the exclusive or sole safety control function. All control functions are designed to dynamically detect failures and operate safely without exception. All products that are designed to incorporate parts supplied by Omron must be provided to the end user and include proper warnings and instructions regarding their safe use and operation. All warnings from Omron must be promptly issued to the end user. Omron offers warranties only for the quality of our products, in compliance with standards and specifications that are described in the manual. Omron does not offer other warranties, either explicit or implied. Injuries, property damage, and lost business opportunities caused by improper storage or handling and negligence oversight on the part of your company or your customers will void our warranty for the product.

#### Note:

Failure to obey the safety messages in the manual can cause serious injury or death. Omron/Yaskawa are not responsible for injuries or damage to equipment caused by ignoring the safety messages.

- Read this manual carefully when mounting, operating, and repairing AC drives.
- Obey all warnings, cautions, and notices.
- Approved personnel must perform all work.
- Install the drive in an area with these conditions.

**⚠ DANGER** *Electrical Shock Hazard. Do not examine, connect, or disconnect wiring on an energized drive. Before servicing, disconnect all power to the equipment and wait for the time specified on the warning label at a minimum. The internal capacitor stays charged after the drive is de-energized. The charge indicator LED extinguishes when the DC bus voltage decreases below 50 Vdc. When all indicators are OFF, remove the covers before measuring for dangerous voltages to make sure that the drive is safe. Failure to obey will cause death or serious injury.*

**⚠ WARNING** *Fire Hazard. Do not connect power supply wiring to drive output terminals U/T1, V/T2, and W/T3. Connect power supply wiring to main circuit input terminals R/L1, S/L2, and T/L3. Failure to obey can cause death or serious injury.*

**⚠ WARNING** *Crush Hazard. Only approved personnel can operate a crane or hoist to move the drive. Failure to obey can cause death or serious injury from falling equipment.*

**⚠ WARNING** *Electrical Shock Hazard. Do not make changes to the drive body or drive circuitry. Failure to obey can cause death or serious injury and will void warranty. Omron/Yaskawa are not responsible for changes to the product made by the user.*

**⚠ WARNING** *Electrical Shock Hazard. Only let authorized persons install, wire, maintain, examine, replace parts, and repair the drive. Failure to obey can cause death or serious injury.*

**⚠ WARNING** *Electrical Shock Hazard. Always ground the motor-side grounding terminal. Contacting the motor case can cause death or serious injury from incorrect equipment grounding.*

**⚠ WARNING** *Electrical Shock Hazard. Do not work on the drive or around the drive while wearing loose clothing or jewelry. Tighten loose clothing and remove all metal objects such as watches or rings. Failure to obey can cause death or serious injury.*

**⚠ WARNING** *Electrical Shock Hazard. The leakage current of the drive will be more than 3.5 mA. The IEC/EN 61800-5-1: 2007 standard specifies that users must wire the power supply to automatically turn off when the protective ground wire disconnects. Users can also connect a protective ground wire that has a minimum cross-sectional area of 10 mm<sup>2</sup> (copper wire) or 16 mm<sup>2</sup> (aluminum wire). Failure to obey these standards can cause death or serious injury.*

**⚠ WARNING** *Sudden Movement Hazard. Remove all persons and objects from the area around the drive, motor, and load before starting Auto-Tuning. The drive and motor can start suddenly during Auto-Tuning and cause death or serious injury.*

**⚠ WARNING** *Sudden Movement Hazard. Remove all persons and objects from the area around the drive, motor, and machine area and attach covers, couplings, shaft keys, and machine loads before energizing the drive. Failure to obey can cause death or serious injury.*

**⚠ WARNING** *Fire Hazard. Do not use the main circuit power supply (Overcurrent Category III) at incorrect voltages. Make sure that the drive rated voltage aligns with the power supply voltage before energizing the drive. Failure to obey can cause death or serious injury.*

**⚠ WARNING** *Fire Hazard. Do not put flammable or combustible materials on top of the drive and do not install the drive near flammable or combustible materials. Attach the drive to metal or other noncombustible material. Failure to obey can cause death or serious injury.*

**⚠ WARNING** *Fire Hazard. Tighten all terminal screws to the correct tightening torque. Connections that are too loose or too tight can cause incorrect operation and damage to the drive. Incorrect connections can also cause death or serious injury from fire.*

**⚠ WARNING** *Fire Hazard. Tighten screws against the bit at an angle in the specified range described in this manual. Tightening screws at an angle outside of the specified range can cause damage the terminal block or start a fire if the connection is loose.*

**⚠ WARNING** *Crush Hazard. Use a lifting mechanism made to move large drives when necessary. Failure to obey can cause death or serious injury from falling equipment.*

**⚠ WARNING** *Electrical Shock Hazard. Do not cause a short circuit on the drive output circuit. Failure to obey can cause death or serious injury.*

**⚠ WARNING** *Electrical Shock Hazard. Always use a type B Residual Current Monitor/Residual Current Device (RCM/RCD) where a residual current operated protective or monitoring device protects against direct or indirect contact as specified by IEC/EN 60755 The drive can cause a residual current with a DC component in the protective earthing conductor. Failure to obey can cause death or serious injury.*

**⚠ WARNING** *Electrical Shock Hazard. Ground the neutral point on the power supply to comply with the EMC Directive before turning on the EMC filter or if there is high resistance grounding. If the EMC filter is switched ON without the neutral point being grounded or if there is high resistance grounding, it can cause death or serious injury.*

**⚠ WARNING** *Electrical Shock Hazard. Do not immediately energize the drive or operate peripheral devices after the drive blows a fuse or trips an RCM/RCD. Wait for the time specified on the warning label at a minimum and make sure that all indicators are OFF. Then check the wiring and peripheral device ratings to find the cause of the problem. Contact Omron before energizing the drive or peripheral devices if the cause is not known. Failure to obey can cause death or serious injury and damage to the drive.*

**⚠ WARNING** *Fire Hazard. Install sufficient branch circuit short circuit protection as specified by applicable codes and this manual. The drive is suited for circuits that supply not more than 100,000 RMS symmetrical amperes, 240 Vac maximum (200 V Class), 480 Vac maximum (400 V Class). Failure to obey can cause death or serious injury.*

**⚠ CAUTION** *Crush Hazard. Do not hold the drive by the front cover or terminal cover. Tighten the screws correctly before moving the drive. Failure to obey can cause minor to moderate injury.*

**⚠ CAUTION** *Burn Hazard. Do not touch a hot drive heatsink. De-energize the drive, wait 15 minutes minimum, and make sure that the heatsink is cool to replace the cooling fans. Failure to obey can cause minor to moderate injury.*

**NOTICE** *Observe correct electrostatic discharge (ESD) procedures when touching the drive and circuit boards. Failure to obey can cause ESD damage to the drive circuitry.*

**NOTICE** *Do not connect or disconnect the motor from the drive while the drive is supplying voltage. Incorrect equipment sequencing can cause damage to the drive.*

**NOTICE** *Do not do a withstand voltage test or Megger test on the drive. Failure to obey can cause damage to the drive.*

**NOTICE** Do not connect or operate damaged equipment or equipment with missing parts. Failure to obey can cause damage to the drive and connected equipment.

**NOTICE** Install fuses and an RCM/RCD. Failure to obey can cause damage to the drive.

**NOTICE** Do not use unshielded wire for control wiring. Use shielded, twisted-pair wires and ground the shield to the ground terminal of the drive. Failure to obey can cause electrical interference and unsatisfactory system performance.

**NOTICE** Do not allow unqualified personnel to use the product. Before you connect a dynamic braking option to the drive, make sure that you review "YASKAWA AC Drive Option Braking Unit, Braking Resistor Unit Instruction Manual (TOBPC72060001)". Failure to obey can cause damage to the drive and braking circuit.

**NOTICE** Make sure that all connections are correct after you install the drive and connecting peripheral devices. Failure to obey can cause damage to the drive.

**NOTICE** Do not connect phase-advancing capacitors or LC/RC noise filters to the output circuits. Failure to obey can cause damage to the drive, phase-advancing capacitors, LC/RC noise filters, and leakage breakers (ELCB, GFCI, or RCM/RCD).

## ■ Intended Use

This AC drive is electrical equipment that controls the speed and rotational direction of a motor in a commercial application. Do not use this product for other functions.

1. Read and understand all safety precautions.
2. Wire and ground the drive as specified by all applicable standards and safety precautions.
3. Tightly attach all parts and protective covers.
4. Always use the product in the correct environmental conditions as specified in this manual.

**Note:**

This product is not designed and manufactured for use in life-support machines or systems.

**⚠ WARNING** Injury to Personnel. This product is manufactured with strict quality-control guidelines. Install applicable safety devices to minimize the risk of accidents when installing the product where its failure could cause a life-or-death situation, loss of human life, or a serious accident or physical injury.

## ■ Exclusion of Liability

Omron/Yaskawa cannot be held responsible for any damages to the product, equipment or persons if this product is used in any other way than specified in [Intended Use on page 4](#).

## ◆ Moving the Drive

Obey local laws and regulations when moving and installing this product.

**⚠ CAUTION** Crush Hazard. Do not hold the drive by the front cover or terminal cover. Tighten the screws correctly before moving the drive. Failure to obey can cause minor to moderate injury.

Drive Weight	Persons Necessary to Move the Drive
< 15 kg (33 lbs.)	1
≥ 15 kg (33 lbs.)	2 + using appropriate lifting equipment

Refer to the Technical Manual for information about moving the drive with suspension systems, wires, or hanging metal brackets.



## ◆ User Interface Elements

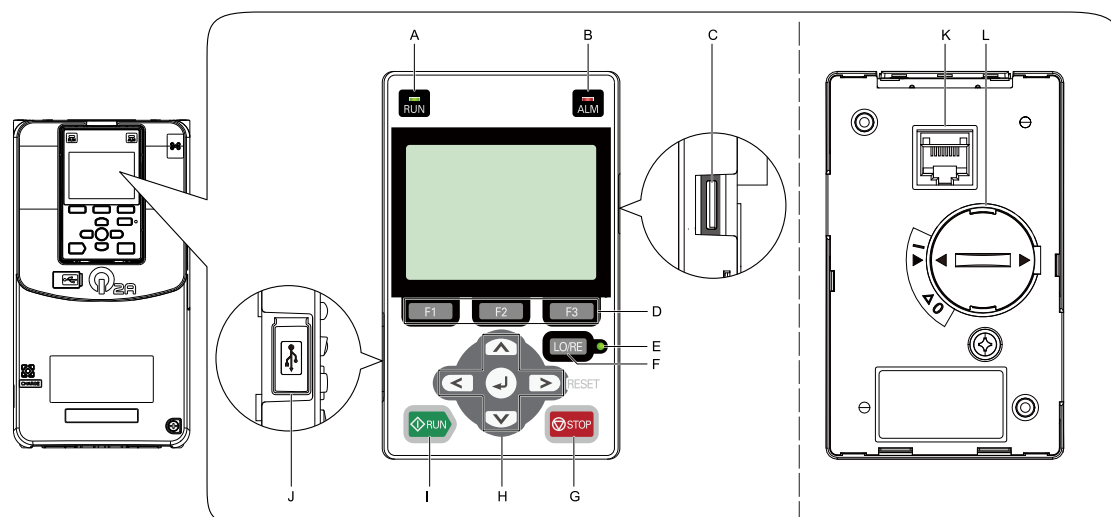

















Figure 1.1 Keypad

Table 1.1 Keypad Components and Functions

Symbol	Name	Function
A	RUN LED 	Illuminates to show that the drive is operating the motor. The LED turns OFF when the drive stops. Flashes to show that: <ul style="list-style-type: none"> <li>The drive is decelerating to stop.</li> <li>The drive received a Run command with a frequency reference of 0 Hz, but the drive is not set for zero speed control.</li> </ul> Flashes quickly to show that: <ul style="list-style-type: none"> <li>The drive received a Run command from the MFDI terminals while switching from LOCAL Mode to REMOTE Mode.</li> <li>The drive received a Run command from the MFDI terminals when the drive is not in Drive Mode.</li> <li>The drive received a Fast Stop command.</li> <li>The safety function shuts off the drive output.</li> <li>The user pushed  on the keypad while the drive is operating in REMOTE Mode.</li> <li>The drive is energized with an active Run command and <math>b1-17 = 1</math> [RUN@PowerUp Selection = Disregard RUN].</li> </ul>
B	ALM LED 	Illuminates when the drive detects a fault. Flashes when the drive detects: <ul style="list-style-type: none"> <li>Alarm</li> <li>Operation Errors</li> <li>A fault or alarm during Auto-Tuning</li> </ul> The light turns off during regular drive operation. There are no alarms or faults.
C	microSD Card Insertion Slot	The insertion point for a microSD card.
D	Function Keys F1, F2, F3 	The menu shown on the keypad sets the functions for function keys. The name of each function is in the lower half of the display window.
E	LOCAL/REMOTE indicator 	Illuminated: The keypad controls the Run command (LOCAL Mode). OFF: The control circuit terminal or serial transmission device controls the Run command (REMOTE Mode). <b>Note:</b> <ul style="list-style-type: none"> <li>LOCAL: Operated using the keypad. Use the keypad to enter Run/Stop commands and the frequency reference command.</li> <li>REMOTE: Operated from the control circuit terminal or serial transmission. Use the frequency reference source entered in <math>b1-01</math> and the Run command source selected in <math>b1-02</math>.</li> </ul>
F	LO/RE Selection Key 	Switches drive control for the Run command and frequency reference between the keypad (LOCAL) and an external source (REMOTE). <b>Note:</b> <ul style="list-style-type: none"> <li>The LOCAL/REMOTE Selection Key continuously stays enabled after the drive stops in Drive Mode. Set <math>o2-01 = 0</math> [LO/RE Key Selection of Function = Disabled] to disable switching from REMOTE to LOCAL by .</li> <li>The drive will not switch between LOCAL and REMOTE when it is receiving a Run command from an external source.</li> </ul>

EN

Symbol	Name	Function
G	STOP Key 	Stops drive operation. <b>Note:</b> Uses a stop-priority circuit. Push  to stop the motor even when a Run command is active at MFDI terminals. Set $a2-02 = 0$ [ <i>STOP Key Selection of Function = Disabled</i> ] to disable the priority in  .
H	Left Arrow Key 	<ul style="list-style-type: none"> <li>Moves the cursor to the left.</li> </ul>
	Up Arrow Key/Down Arrow Key 	<ul style="list-style-type: none"> <li>Scrolls up or down to display the next item or the previous item.</li> <li>Selects parameter numbers, and increments or decrements setting values.</li> </ul>
	Right Arrow Key (RESET) 	<ul style="list-style-type: none"> <li>Moves the cursor to the right.</li> <li>Continues to the next screen.</li> <li>Restarts the drive to clear a fault.</li> </ul>
	ENTER Key 	<ul style="list-style-type: none"> <li>Enters parameter values and settings.</li> <li>Selects menu items to move the user between keypad displays.</li> <li>Selects each mode, parameter, and set value.</li> </ul>
I	RUN Key 	Starts the drive in LOCAL Mode. Starts the operation in Auto-Tuning Mode. <b>Note:</b> Push  on the keypad to set the drive to LOCAL Mode before operating the motor with the keypad.
J	USB Terminal	Insertion point for a USB cable (USB 2.0, type: A - mini-B). Use the USB cable to connect the drive to a PC.
K	RJ-45 Connector	Connects to the drive using an RJ-45 8-pin straight through UTP CAT5e cable or keypad connector.
L	Clock Battery Cover	Remove this cover to install or replace the clock battery.

**⚠ WARNING** Sudden Movement Hazard. The drive may start unexpectedly if switching control sources when setting  $b1-07 = 2$  [*LOCAL/REMOTE Run Selection = Accept RUN*]. Clear all personnel from rotating machinery and electrical connections prior to switching control sources. Failure to comply may cause death or serious injury.

## ■ Keypad Mode and Menu Displays

### Note:



- Energize the drive with factory defaults to show the Initial Setup screen. Push  (Home) to show the HOME screen.
  - Select [No] from the [Show Initial Setup Screen] setting to skip Initial Setup screen during power up.
- Push  from the Home screen to show drive monitors.
- Push  to set  $d1-01$  [*Reference 1*] when the Home screen shows  $U1-01$  [*Frequency Reference*] in LOCAL Mode.
- The keypad will show [Rdy] when the drive is in Drive Mode. The drive is prepared to accept a Run command.
- The drive will not accept a Run command in Programming Mode in the default setting. Set  $b1-08$  [*RUN@PRG Mode Selection*] to accept or reject a Run command from an external source while in Programming Mode.
  - Set  $b1-08 = 1$  [*NoRUN@Program*] to reject the Run command from an external source while in Programming Mode (default).
  - Set  $b1-08 = 2$  [*RUN@Program*] to accept the Run command from an external source while in Programming Mode.
  - Set  $b1-08 = 3$  [*Program@Stop only*] to prevent changes from Drive Mode to Programming Mode while the drive is operating.

Table 1.2 Drive Modes, Menu Screens and Functions

Mode	Menu Screen	Function
Drive Mode	MONITORS	Sets monitor items to display.
Programming Mode	AUTOTUNING	Auto-Tunes the drive.
	INITIALIZATION	Changes initial settings.
	APPLICATION	Changes application settings.
	TUNING	Changes tuning settings.
	REFERENCE	Changes reference settings.
	MOTOR	Changes motor settings.
	OPTIONS	Changes external options settings.
	TERMINALS	Changes terminals settings.
	PROTECTION	Changes protection settings.
	SPECIAL	Changes settings for special applications.
	KEYPAD	Changes keypad settings.
	Q2PACK PARAMETERS	Changes parameters of Q2Pack software.
Q2PACK JOINTS	Changes joints of Q2Pack software.	

## ◆ Mechanical Installation

**⚠ WARNING** *Fire Hazard. Do not put flammable or combustible materials on top of the drive and do not install the drive near flammable or combustible materials. Attach the drive to metal or other noncombustible material. Failure to obey can cause death or serious injury.*

**⚠ CAUTION** *Crush Hazard. Do not hold the drive by the front cover or terminal cover. Tighten the screws correctly before moving the drive. Failure to obey can cause minor to moderate injury.*

**NOTICE** *Do not put drive peripheral devices, transformers, or other electronics near the drive. Shield the drive from electrical interference if components must be near the drive. Failure to obey can cause incorrect operation.*

**NOTICE** *Do not let unwanted objects, for example metal shavings or wire clippings, fall into the drive during drive installation and project construction. Put a temporary cover over the top of the drive during installation. Remove the temporary cover before start-up or the drive will overheat. Failure to obey can cause damage to the drive.*

**NOTICE** *Install the drive as specified by EMC Guidelines. Failure to obey can cause incorrect operation and damage to electrical devices.*

## ■ Installation Environment

The installation environment is important for the lifespan of the product and to make sure that the drive performance is correct. Make sure that the installation environment agrees with these specifications.

Environment	Conditions
Area of Use	Indoors, 3C2 ( IEC 60721-3-3 )
Power Supply	Overvoltage Category III (IEC 61800-5-1)
Ambient Temperature Setting	IP20 enclosure: -10 °C to +60 °C (14 °F to 140 °F). Derate the output current and output voltage if the drive is installed in areas with ambient temperatures from +50 °C to +60 °C (122 °F to 140 °F). UL Type 1 enclosure: -10 °C to +50 °C (14 °F to 122 °F). Derate the output current and output voltage if the drive is installed in areas with ambient temperatures from +40 °C to +50 °C (104 °F to 122 °F). <ul style="list-style-type: none"> <li>• Drive reliability is better in environments that do not have wide temperature fluctuations.</li> <li>• When installing the drive in an enclosure, use a cooling fan or air conditioner to keep the internal air temperature in the permitted range.</li> </ul>
Humidity	95% RH or less, non-condensing
Storage Temperature	-20 °C to +70 °C (-4 °F to +158 °F)
Surrounding Area	Pollution degree 2 (IEC 62477-1) or less Install the drive in an area without: <ul style="list-style-type: none"> <li>• Oil mist, corrosive or flammable gas, or dust</li> <li>• Metal powder, oil, water, or other unwanted materials</li> <li>• Radioactive materials or flammable materials, including wood</li> <li>• Harmful gas or fluids</li> <li>• Salt</li> <li>• Direct sunlight</li> </ul> Keep wood and other flammable materials away from the drive.

Environment	Conditions
Altitude	1000 m (3281 ft.) maximum <b>Note:</b> Derate the output current by 1% for each 100 m (328 ft.) to install the drive in altitudes between 1000 m to 4000 m (3281 ft. to 13123 ft.). It is not necessary to derate the rated voltage in these conditions: • When installing the drive at 2000 m (6562 ft.) or lower • When installing the drive between 2000 m to 4000 m (6562 ft. to 13123 ft.) and grounding the neutral point on the power supply. Contact the manufacturer or your nearest sales representative when not grounding the neutral point.
Vibration	<ul style="list-style-type: none"> <li>10 Hz to 20 Hz: 1 G (9.8 m/s<sup>2</sup>, 32.15 ft/s<sup>2</sup>)</li> <li>20 Hz to 55 Hz: Models 4208 to 4675: 0.2 G (2.0 m/s<sup>2</sup>, 6.56 ft/s<sup>2</sup>)</li> </ul>
Installation Position	Install the drive vertically for sufficient cooling airflow.

## ■ Removing the Covers

**⚠ DANGER** *Electrical shock Hazard. Disconnect the power to the drive and wait for the charge indicator LED to go off, then remove the covers. Failure to obey could cause death or serious injury.*

## ◆ Electrical Installation

**⚠ DANGER** *Electrical Shock Hazard. Do not examine, connect, or disconnect wiring on an energized drive. Before servicing, disconnect all power to the equipment and wait for the time specified on the warning label at a minimum. The internal capacitor stays charged after the drive is de-energized. The charge indicator LED extinguishes when the DC bus voltage decreases below 50 Vdc. When all indicators are OFF, remove the covers before measuring for dangerous voltages to make sure that the drive is safe. Failure to obey will cause death or serious injury.*

**⚠ DANGER** *Electrical Shock Hazard. Make sure that all electrical connections are correct and install all drive covers before energizing the drive. Use terminals for their intended function only. Incorrect wiring or ground connections, and incorrect repair of protective covers can cause death or serious injury.*

**⚠ WARNING** *Electrical Shock Hazard. Correctly ground the drive before turning on the EMC filter switch. Failure to obey can cause death or serious injury.*

**⚠ WARNING** *Electrical Shock Hazard. Used the terminals for the drive only for their intended purpose. Refer to the technical manual for more information about the I/O terminals. Wiring and grounding incorrectly or modifying the cover may damage the equipment or cause injury.*

## ■ Standard Connection Diagram

Wire the drive as specified by [Figure 1.2](#).

**⚠ WARNING** *Sudden Movement Hazard. Set the MFDI terminal parameters before you close the control circuit wiring. Incorrect Run/Stop circuit sequence settings can cause death or serious injury from moving equipment.*

**⚠ WARNING** *Sudden Movement Hazard. Correctly wire the start/stop and safety circuits before energizing the drive. Momentarily closing a digital input terminal can start a drive that is programmed for 3-Wire control. Failure to obey can cause death or serious injury from moving equipment.*

**⚠ WARNING** *Sudden Movement Hazard.*

*When using a 3-Wire sequence:*

- Set the drive for 3-Wire sequence.
- Set b1-17 = 1 [RUN@PowerUp Selection = Disregard RUN]
- Wire the drive for 3-Wire sequence.

*If these three conditions are correct, the motor can rotate in reverse when energizing the drive:*

- The drive is wired for 3-Wire sequence.
- The drive is set for a 2-Wire sequence (default).
- b1-17 = 2 [Accept RUN]

*Failure to obey can cause death or serious injury from moving equipment.*

**NOTICE** *Fire Hazard. Install sufficient branch circuit short circuit protection as specified by applicable codes and this manual. The drive is suited for circuits that supply not more than 100,000 RMS symmetrical amperes, 240 Vac maximum (200 V Class), 480 Vac maximum (400 V Class). Failure to obey can cause death or serious injury.*

**NOTICE** *When the input voltage is 440 V or higher or if the wiring distance is longer than 100 m (328 ft.) be sure to use a drive duty motor or carefully monitor the motor insulation voltage. Failure to obey can cause damage to the motor insulation.*

**NOTICE** *Do not connect the AC control circuit ground to the drive enclosure. Failure to obey can cause incorrect control circuit operation.*

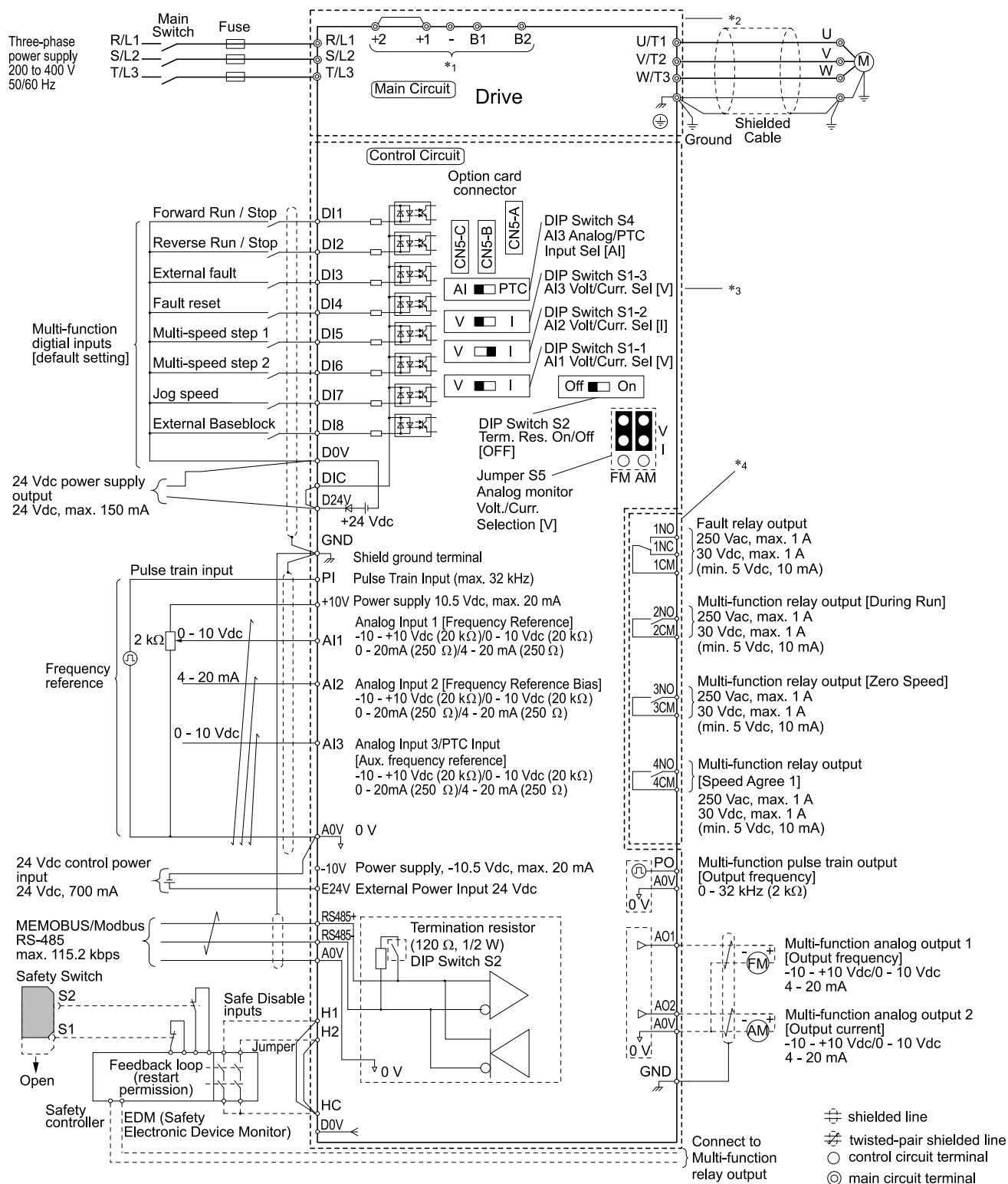

Figure 1.2 Standard Connection Diagram

- \*1 Connect peripheral options to terminals -, +1, +2, B1, and B2.
- \*2 For circuit protection, the main circuit is separated from the surface case that can touch the main circuit.
- \*3 The control circuit is a Safety Extra-Low Voltage circuit. Separate this circuit from other circuits with reinforced insulation. Make sure that the Safety Extra-Low Voltage circuit is connected as specified.
- \*4 Reinforced insulation separates the output terminals from other circuits. Users can also connect circuits that are not Safety Extra-Low Voltage circuits if the drive output is 250 Vac 1 A max. or 30 Vdc 1 A maximum.

## Control Circuit Wire Gauges and Tightening Torques

Use shielded wire for control circuit terminal wiring. Use crimp ferrules on the wire ends for more reliable wiring.

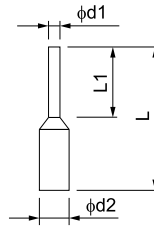

**Table 1.3 Wire Gauges**

Terminal	Bare Wire		Crimp Ferrule	
	Recommended Gauge mm <sup>2</sup> (AWG)	Applicable Gauge mm <sup>2</sup> (AWG)	Recommended Gauge mm <sup>2</sup> (AWG)	Applicable Gauge mm <sup>2</sup> (AWG)
DI1-DI8, DIC, D0V, D24V H1, H2, HC PI, +10V, -10V, AI1, AI2, AI3, A0V PO, AO1, AO2, A0V RS485+, RS485-, A0V 1NO, 1NC, 1CM, 2NO, 2CM, 3NO, 3CM, 4NO, 4CM E24V, GND	0.75 (18)	<ul style="list-style-type: none"> <li>Stranded wire 0.2 to 1.0 (24 to 18)</li> <li>Solid wire 0.2 to 1.5 (24 to 16)</li> </ul>	0.5 (20)	0.25 to 0.5 (24 to 20)

**Crimp Ferrules**

Attach an insulated sleeve to the wire when connecting crimp ferrules. We recommend the CRIMPFOX 6 crimping tool from PHOENIX CONTACT.



**Figure 1.3 Crimp Ferrule Dimensions**

**Table 1.4 Crimp Ferrule Models and Dimensions**

Wire Gauge mm <sup>2</sup> (AWG)	Model	L (mm)	L1 (mm)	d1 (mm)	d2 (mm)
0.25 (24)	AI 0.25-8YE	12.5	8	0.8	2.0
0.34 (22)	AI 0.34-8TQ	12.5	8	0.8	2.0
0.5 (20)	AI 0.5-8WH, AI 0.5-8OG	14	8	1.1	2.5

**◆ Drive Start-Up**

**■ Setup Wizard**

Refer to the motor nameplate and record the information in this table before you start the drive.

Item	Value	Item	Value
Motor Rated Power	kW	Motor Maximum Frequency	Hz
Motor Rated Voltage	V	Number of Motor Poles	
Motor Rated Current	A	Motor Base Rotation Speed	min <sup>-1</sup> (r/min)
Motor Rated Frequency	Hz	Number of Motor Encoder Pulses	ppr

Open the clock battery cover to put in a battery to use the clock functions. Select a type CR2016 battery with a nominal voltage of 3 V.

**◆ Drive Parameters**

Refer to the following table when setting the most important parameters.

**Note:**

You can change parameters with “RUN” in the “No.” column during Run.

No. (Hex.)	Name	Description
A1-00 (0100) RUN	Language Selection	Sets the language for the LCD keypad. 1: English, 2: Japanese, 3: German, 4: French, 5: Italian, 6: Spanish, 7: Portuguese, 8: Chinese, 9: Czech, 10: Russian, 11: Turkish, 12: Polish, 13: Greek
A1-03 (0103)	Init Parameters	Sets parameters to default values. 0: No Initialization, 1110: User / Solution Initialization, 2220: 2-Wire Initialization, 3330: 3-Wire Initialization

No. (Hex.)	Name	Description
b1-01 (0180)	Freq. Ref. Sel. 1	Sets the input method for the frequency reference. 0: Keypad, 1: Analog Input, 2: Modbus, 3: Option PCB, 4: Pulse Train Input
b1-02 (0181)	Run Comm. Sel. 1	Sets the input method for the Run command. 0: Keypad, 1: Analog Input, 2: Modbus, 3: Option PCB
b1-03 (0182)	Stopping Method Selection	Sets the method to stop the motor after removing a Run command or entering a Stop command. 0: Ramp->Stop, 1: Coast->Stop, 2: DC Inj->Stop, 3: Timed Coast->Stop, 9: Distance Stop
b1-04 (0183)	Reverse Operation Selection	Sets the reverse operation function. Disable reverse operation in fan or pump applications where reverse rotation is dangerous. 0: Enabled, 1: Disabled
C1-01 (0200) RUN	Accel Time 1	Sets the length of time to accelerate from zero to maximum output frequency.
C1-02 (0201) RUN	Decel Time 1	Sets the length of time to decelerate from maximum output frequency to zero.
C2-01 (020B)	Jerk@Start of Accel	Sets the jerk acceleration time at start.
C2-02 (020C)	Jerk@End of Accel	Sets the jerk acceleration time at completion.
C2-03 (020D)	Jerk@Start of Decel	Sets the jerk deceleration time at start.
C2-04 (020E)	Jerk@End of Decel	Sets the jerk deceleration time at completion.
C6-01 (0223)	ND/HD Duty Selection	Sets the drive duty rating. 0: HD Rating, 1: ND Rating
C6-02 (0224)	Carrier Frequency Selection	Sets the carrier frequency for the transistors in the drive. 1: 2.0 kHz, 2: 5.0 kHz (4.0 kHz for AOLV/PM), 3: 8.0 kHz (6.0 kHz for AOLV/PM), 4: 10.0 kHz (8.0 kHz for AOLV/PM), 5: 12.5 kHz (10.0 kHz for AOLV/PM), 6: 15.0 kHz (12.0 kHz AOLV/PM), 7: Swing PWM 1 (Audible Sound 1), 8: Swing PWM 2 (Audible Sound 2), 9: Swing PWM 3 (Audible Sound 3), A: Swing PWM 4 (Audible Sound 4), F: User Defined (C6-03 to C6-05)
d1-01 to d1-16 (0280 - 0291) RUN	Reference 1 to Reference 16	Sets the frequency reference in the units from <i>o1-03 [FrqDisplay Unit Selection]</i> .
d1-17 (0292) RUN	Jog Reference	Sets the JOG frequency reference in the units from <i>o1-03 [FrqDisplay Unit Selection]</i> . Set <i>H1-xx: MFDI Function Select = 6 [Jog Reference Selection]</i> to use the Jog frequency reference.
d2-01 (0289)	FRef Upper Limit	Sets maximum limit for all frequency references. This value is a percentage of <i>E1-04 [Max Output Frequency]</i> .
d2-02 (028A)	FRef Lower Limit	Sets minimum limit for all frequency references. This value is a percentage of <i>E1-04 [Max Output Frequency]</i> .
E1-01 (0300)	Input AC Supply Voltage	Sets the drive input voltage.
E1-04 (0303)	Max Output Frequency	Sets the maximum output frequency for the V/f pattern.
E1-05 (0304)	Max Output Voltage	Sets the maximum output voltage for the V/f pattern.
E1-06 (0305)	Base Frequency	Sets the base frequency for the V/f pattern.
E1-09 (0308)	Min Output Frequency	Sets the minimum output frequency for the V/f pattern.
E2-01 (030E)	Mot Rated Current (FLA)	Sets the motor rated current in amps.
E2-11 (0318)	Motor Rated Power (kW)	Sets the motor rated output in 0.01 kW increments.
H1-01 - H1-08 (0438, 0439, 0400 - 0405)	DI1 Function Selection to DI8 Function Selection	Sets the functions for MFDI terminals DI1 to DI8.
H2-01 (040B)	2NO-2CM Func Selection	Sets the function for MFDO terminal 2NO-2CM.
H2-02 (040C)	3NO-3CM Func Selection	Sets the function for MFDO terminal 3NO-3CM.

No. (Hex.)	Name	Description
H2-03 (040D)	4NO-4CM Funct Selection	Sets the function for MFDO terminal 4NO-4CM.
H3-01 (0410)	A11 Signal Level Select	Sets the input signal level for MFAI terminal A1. 1: -10 to +10V (Bipolar Reference), 2: 0 to 10V (Lower Limit at 0), 3: 0 to 20 mA, 4: 4 to 20 mA
H3-02 (0434)	A11 Function Selection	Sets a function for MFAI terminal A1.
H3-03 (0411) RUN	A11 Gain Setting	Sets the gain of the analog signal input to MFAI terminal A1.
H3-04 (0412) RUN	A11 Bias Setting	Sets the bias of the analog signal input to MFAI terminal A1.
H3-05 (0413)	A13 Signal Level Select	Sets the input signal level for MFAI terminal A3. 1: -10 to +10V (Bipolar Reference), 2: 0 to 10V (Lower Limit at 0), 3: 0 to 20 mA, 4: 4 to 20 mA
H3-06 (0414)	A13 Function Selection	Sets a function for MFAI terminal A3.
H3-07 (0415) RUN	A13 Gain Setting	Sets the gain of the analog signal input to MFAI terminal A3.
H3-08 (0416) RUN	A13 Bias Setting	Sets the bias of the analog signal input to MFAI terminal A3.
H3-09 (0417)	A12 Signal Level Select	Sets the input signal level for MFAI terminal A2. 1: -10 to +10V (Bipolar Reference), 2: 0 to 10V (Lower Limit at 0), 3: 0 to 20 mA, 4: 4 to 20 mA
H3-10 (0418)	A12 Function Selection	Sets a function for MFAI terminal A2.
H3-11 (0419) RUN	A12 Gain Setting	Sets the gain of the analog signal input to MFAI terminal A2.
H3-12 (041A) RUN	A12 Bias Setting	Sets the bias of the analog signal input to MFAI terminal A2.
H3-13 (041B)	An.In FilterTime Constant	Sets the time constant to apply a primary delay filter to the MFAI terminal.
H3-14 (041C)	An.In Term.Enable Sel	Sets the enabled terminal or terminals when <i>H1-xx: MFDI Function Select = C [Analog Terminal Input Selection]</i> is ON. 1: A1 only, 2: A2 only, 3: A1 and A2, 4: A3 only, 5: A1 and A3, 6: A2 and A3, 7: A1, A2, and A3
H4-01 (041D)	AO1 An.Out Select	Sets the monitor number to send from MFAO terminal FM.
H4-02 (041E) RUN	AO1 An.Out Gain	Sets the gain of the monitor signal that is sent from MFAO terminal FM.
H4-03 (041F) RUN	AO1 An.Out Bias	Sets the bias of the monitor signal that is sent from MFAO terminal FM.
H4-04 (0420)	AO2 An.Out Select	Sets the monitoring number to be output from the MFAO terminal AM.
H4-05 (0421) RUN	AO2 An.Out Gain	Sets the gain of the monitor signal that is sent from MFAO terminal AM.
H4-06 (0422) RUN	AO2 An.Out Bias	Sets the bias of the monitor signal that is sent from MFAO terminal AM.
H4-07 (0423)	AO1 Signal Level Select	Sets the MFAO terminal FM output signal level. 1: 0 to 10 Vdc, 2: -10 to +10 Vdc, 3: 4 to 20 mA
H4-08 (0424)	AO2 Signal Level Select	Sets the MFAO terminal AM output signal level. 1: 0 to 10 Vdc, 2: -10 to +10 Vdc, 3: 4 to 20 mA
L1-01 (0480)	Motor Cool Type for OL1 Calc	Sets the motor overload protection with electronic thermal protectors. 1: Disabled, 2: VTorque, 3: CT 10:1 Speed Range, 4: CT 100:1 SpeedRange, 5: PM VTorque, 6: PM CTorque, 7: VT (50Hz)

No. (Hex.)	Name	Description
L1-02 (0481)	OL1 Protect Time	Sets the operation time for the electronic thermal protector of the drive to prevent damage to the motor. Usually it is not necessary to change this setting.
L3-04 (0492)	StallP@Decel Enable	Enables Stall Prevention during deceleration. 0: Disabled, 1: Enabled
L3-50 (0458)	StallP@Decel Mode	Sets the method that the drive will use to prevent overvoltage faults when decelerating. 0: General Purpose, 1: Automatic Decel Reduction, 2: Gen Purpose w/ DB Resistor, 3: HiFlux Overexcitation, 4: HiFlux2 Overexcitation

## ◆ Troubleshooting

If the drive or motor do not operate correctly, look at the drive keypad for fault and alarm information.

### • For drive faults:

- The keypad shows the fault code.

-  and ALM/ERR on the LED Status Ring stay illuminated.

- The drive shuts off output, the fault relay output turns ON, and the motor coasts to stop. The motor coasts to stop.



### • For drive alarms:

- The keypad shows the alarm code.

-  and ALM/ERR on the LED Status Ring flash.

- The drive will continue to operate the motor. Some alarms let you select a motor stopping method.

## ■ Fault Reset Procedure

1. Remove the cause of the alarm or fault.
2. While the keypad is showing the fault or alarm code, push  (Reset) or  on the keypad.

This table lists the most frequent alarms and faults with possible causes and solutions.

Refer to the Technical Manual for a full list of faults and alarms.

Code	Name	Causes	Possible Solutions
bb	Baseblock	A digital input set for the software baseblock function is OFF and the drive will not accept a Run command.	<ul style="list-style-type: none"> <li>• Make sure that the digital input function selections are correct.</li> <li>• Make sure that the host controller sequence is correct.</li> </ul>
CrST	Remove RUN Command to Reset	Tried to reset a fault when a Run command was active.	Stop the Run command and reset the drive.
EF	FWD/REV Run Command Input Error	A forward command and a reverse command were input at the same time for longer than 500 ms.	Make sure that the sequence is correct. Do not set the forward and reverse inputs at the same time.
EF1 to EF8	External Fault (Terminal DIx)	One of the digital inputs caused an external fault through an external device. The digital input settings are incorrect.	<ul style="list-style-type: none"> <li>• Find the device that caused the external faults. Remove the cause and reset the fault.</li> <li>• Make sure that the digital input terminal functions are correct.</li> </ul>
GF	Ground Fault	A current short to ground was more than 50% of the rated current on the output side of the drive.	<ul style="list-style-type: none"> <li>• Make sure that the output wiring is correct.</li> <li>• Make sure that the motor does not have short circuits or damaged insulation.</li> </ul>
		The motor wiring or insulation are damaged.	Replace damaged parts.
		Too much parasitic capacitance at drive output.	Reduce the carrier frequency in C6-02 [Carrier Frequency Selection].
oC	Overcurrent	<ul style="list-style-type: none"> <li>• There is a short circuit or ground fault on the drive output side.</li> <li>• The load is too heavy.</li> <li>• The accel/decel times are too short.</li> <li>• The motor data is incorrect.</li> <li>• The V/f pattern settings are incorrect.</li> <li>• A magnetic contactor was switched at the output.</li> </ul>	<ul style="list-style-type: none"> <li>• Replace damaged output wiring and motor wiring.</li> <li>• Repair damaged machine parts.</li> <li>• Make sure that the drive parameter settings are correct.</li> <li>• Make sure that the output contactor sequence is correct.</li> </ul>
oL1	Motor Overload	The motor load is too heavy.	Decrease the motor load.
		Operating a general-purpose motor slower than the rated speed with a high load.	Use a motor with external cooling and set the correct motor type in L1-01 [Motor Cool Type for OL1 Calc].

		Cycle times are too short during acceleration and deceleration.	Increase the acceleration and deceleration times.
		The motor rated current setting is incorrect.	Make sure that the motor rated current in <i>E2-01 [Mot Rated Current (FLA)]</i> is correct.
oL2	Drive Overload	<ul style="list-style-type: none"> <li>The load is too heavy.</li> <li>The drive capacity is too small.</li> <li>Torque is too high at low speed.</li> </ul>	<ul style="list-style-type: none"> <li>Examine the load.</li> <li>Make sure that the drive is sufficiently large for the load.</li> <li>The overload capability of the drive decreases at low speeds. Decrease the load or replace the drive with a larger capacity model.</li> </ul>
ov	Overvoltage	<ul style="list-style-type: none"> <li>The DC bus voltage is too high.</li> <li>The deceleration time is too short.</li> <li>Stall prevention is disabled.</li> <li>The braking resistor is missing or damaged.</li> <li>Motor control is not stable.</li> <li>The input voltage is too high.</li> </ul>	<ul style="list-style-type: none"> <li>Increase the deceleration time.</li> <li>Set <i>L3-04 = 1 [StallP@Decel Enable = Enabled]</i> to enable stall prevention.</li> <li>Replace the braking resistor.</li> <li>Make sure that motor parameter settings are correct and adjust torque and slip compensation if necessary.</li> <li>Make sure that the power supply voltage meets drive specifications.</li> </ul>
PF	Input Phase Loss	Drive input power has an open phase.	Correct all wiring errors in the main circuit drive input power.
		The drive input power terminals are not tight.	Tighten the terminals to the correct tightening torque.
		Too much fluctuation in the drive input power voltage.	<ul style="list-style-type: none"> <li>Measure the voltage from the drive input power.</li> <li>Make the drive input power stable.</li> </ul>
		There is unsatisfactory balance between voltage phases.	<ul style="list-style-type: none"> <li>Make the drive input power stable.</li> <li>Disable phase loss detection.</li> </ul>
		The main circuit capacitors are unserviceable.	<ul style="list-style-type: none"> <li>Make sure that the capacitor maintenance time in monitor <i>U4-05 [Capacitor Maintenance]</i> is less than 90%.</li> <li>Replace the main capacitors if <i>U4-05</i> is more than 90%. Contact the manufacturer or a representative to replace the main capacitors.</li> </ul>
		Make sure that there are no problems with the drive input power. If drive input power is correct and the alarm continues to occur, replace the control board or the drive. Contact the manufacturer or a representative to replace the control board.	
STo	Safe Torque OFF	The two Safe Disable inputs are open. The drive output is safely disabled and the motor will not start.	<ul style="list-style-type: none"> <li>Find the problem causing the host controller safety device to disable the drive.</li> <li>If the Safe Disable function does not disable the drive or if it is not used for the ISO/EN 13849-1 (PL e (Cat.III)), and IEC/EN 61508 (SIL3), connect a jumper between terminals HC, H1, and H2.</li> </ul>
SToF	Safe Torque OFF Hardware	<p>Opening only one Safe Disable input disables drive output. (Usually inputs H1 and H2 must open to disable drive output.)</p> <ul style="list-style-type: none"> <li>One input is damaged and will not switch off after removing the external signal.</li> <li>The host controller switched off one input.</li> </ul>	<ul style="list-style-type: none"> <li>Make sure that the wiring from the host controller is correct and the controller set the two signals correctly.</li> <li>If the signals are correct and the alarm continues to occur, replace the drive.</li> </ul>

## ◆ Disposal Instructions

Correctly discard the drive, packing material, battery, and microSD card as specified by regional, local, and municipal laws and regulations for this product.



**Note:**

- Remove the battery and microSD card from the keypad before you discard the drive.
- We recommend that customers physically destroy the microSD card in a shredder or use data wipe software to fully erase the card.

## ◆ European Standards



Figure 1.4 CE Mark



The CE Mark identifies that the product meets environmental and safety standards in the European Union. Products manufactured, sold, or imported in the European Union must display the CE Mark.

European Union standards include standards for electrical appliances (Low Voltage Directive), standards for electrical noise (EMC Directive), and standards for machinery (Machinery Directive).

This product displays the CE Mark in accordance with the Low Voltage Directive, the EMC Directive, and the Machinery Directive.

**Table 1.5 Harmonized Standard**

European Directive	Harmonized Standard
CE Low Voltage Directive Compliance 2014/35/EU	IEC/EN 61800-5-1:2007
EMC Directive 2014/30/EU	EN 61800-3 2004+A1:2012
Machinery Directive 2006/42/EC	<ul style="list-style-type: none"> <li>• EN ISO 13849-1/AC:2009 (PL e (Cat.III))</li> <li>• IEC 62061/A1:2012 (SIL CL 3)</li> <li>• EN 62061/A1:2013 (SIL CL 3)</li> <li>• IEC/EN 61800-5-2:2007 (SIL3)</li> </ul>

### ■ CE Low Voltage Directive Compliance

This product is tested according to IEC/EN 61800-5-1:2007 and complies with the CE Low Voltage Directive. The following conditions must be satisfied for machines and devices incorporating this product to comply with the CE Low Voltage Directive.

### ■ Area of Use

Install this product in a location with overvoltage category III and pollution degree 2 or less. These standards are defined by IEC/EN 60664.

### ■ Guarding against Debris

When installing IP20 enclosure drives (model: 4xxxxB), use an enclosure that does not let unwanted material enter the drive from above or below.

### ■ Connect a Fuse to the Input Side (Primary Side)

The drive circuit protection must comply with IEC/EN 61800-5-1:2007 for protection against a short circuit in the internal circuitry. Connect a semiconductor protection fuse on the input side for branch circuit protection.

Refer to [Factory Recommended Branch Circuit Protection on page 31](#).

**⚠ WARNING** *Electrical Shock Hazard. Do not immediately energize the drive or operate peripheral devices after the drive blows a fuse or trips an RCM/RCD. Wait for the time specified on the warning label at a minimum and make sure that all indicators are OFF. Then check the wiring and peripheral device ratings to find the cause of the problem. Contact the manufacturer before energizing the drive or peripheral devices if the cause is not known. Failure to obey can cause death or serious injury and damage to the drive.*

### ■ EMC Directive

All drives were tested in accordance with European standard IEC/EN 61800-3:2004/A1:2012, and comply with the EMC Directive.

Use drives with built-in EMC filters or install external EMC filters to the drive input side to comply with the EMC Directive.

### ■ Install a Drive to Conform to the EMC Directive

Install drives with this procedure to comply with the EMC Directive when the drive is a single unit or installed in a larger device.

1. Install the drive on a grounded metal plate.
2. Wire the drive and motor.
3. Enable the internal EMC filter.

4. Ground the wire shielding on the drive side and motor side.

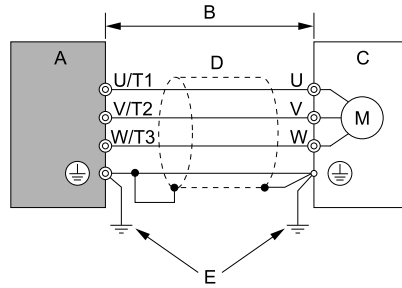

- A - Drive  
 B - 10 m (32.8 ft.) maximum  
 C - Motor  
 D - Metal conduit  
 E - Grounding wire

Figure 1.5 Wiring the Drive and Motor

5. Use a cable clamp to ground the motor cable to the metal plate.

**Note:**

Make sure that the protective ground wire complies with technical specifications and local safety standards.

6. Connect an AC or DC reactor to decrease harmonic distortion.

**Note:**

- To maintain compliance with IEC/EN 61000-3-2 on drive models 4002, and 4004, install a DC reactor.
- The main circuit terminal block for the drive and the terminal blocks for the DC reactor come in different shapes. Correctly prepare the ends of the wiring.

## ■ Enable the Internal EMC Filter

Move the screw or screws to turn ON and OFF (enable and disable) the EMC filter. The EMC filter switch screw or screws are installed in the OFF position by default.

**⚠ WARNING** *Electrical Shock Hazard. Make sure that the power to the drive is OFF and the CHARGE LED light is OFF before you move the EMC filter screw or screws. Failure to obey could cause death or serious injury.*

**⚠ WARNING** *Electrical Shock Hazard. Do not remove covers or touch circuit boards while the drive is energized. Failure to obey can cause death or serious injury.*

**⚠ WARNING** *Electrical Shock Hazard. Ground the neutral point on the power supply to comply with the EMC Directive before turning on the EMC filter or if there is high resistance grounding. If the EMC filter is switched ON without the neutral point being grounded or if there is high resistance grounding, it can cause death or serious injury.*

**⚠ WARNING** *Electrical Shock Hazard. Connect the ground cable correctly. Failure to obey can cause death or serious injury.*

**NOTICE** *When disabling the internal EMC filter, move the screws from ON to OFF and then tighten to the specified torque. Completely removing the screws or tightening the screws to an incorrect torque may cause drive failure.*

**NOTICE** *Move the EMC switch screw or screws to the OFF position for networks that are not symmetrically grounded. Failure to obey can cause damage to the drive.*

Make sure that the symmetric grounding network is applied, and install the screw or screws in the ON position to enable the built-in EMC filter in compliance with the EMC Directive.

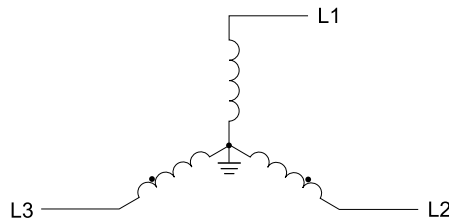

Figure 1.6 Symmetric Grounding

**NOTICE** *When operating the drive with a non-grounding network, high resistance grounding, asymmetric grounding network, install the screw or screws in the OFF position to disable the built-in EMC filter. Failure to obey the instructions can damage the drive.*

If you lose an EMC filter switch screw, install the correct size screw with the correct tightening torque.

**NOTICE** *Only use the screws specified in this manual. Failure to obey could damage the drive.*

Table 1.6 Screw Sizes and Tightening Torques

Model	Screw Size	Tightening Torque N·m
4002 - 4060	M4 × 20	1.0 - 1.3
4075 - 4168	M4 × 25	1.0 - 1.3
4208 - 4675	M5 × 25	2.0 - 2.5

## ◆ Safe Disable Input



Figure 1.7 TUV Mark

The TUV mark identifies that the product complies with the safety standards.

This section gives precautions to support the Safe Disable input. Contact the manufacturer for more information.

Table 1.7 Applied Safety Standards and Unified Standards

Safety Standards	Unified Standards
Functional Safety	IEC/EN 61508:2010 (SIL3)
	IEC/EN 62061/A2:2015 (SILCL3)
	IEC/EN 61800-5-2:2007 (SIL3)
Machine Safety	ISO/EN ISO 13849-1:2015 (Cat.3, PL e)
EMC	IEC/EN 61000-6-7:2015, IEC/EN61326-3-1:2008

### Note:

SIL = Safety Integrity Level.

## ■ Safe Disable Specifications

The Safe Disable input provides the stop function compliant to “Safe Torque Off” defined in IEC/EN 61800-5-2:2007. The Safe Disable input is designed to meet the requirements of EN ISO 13849-1 and IEC/EN 61508. It is also equipped with the safety status monitor to detect safety circuit errors.

Table 1.8 Specifications for the Safety Function

Item	Description
Input/output	<ul style="list-style-type: none"> <li>Input: 2 Safe Disable input (H1, H2) Signal ON level: 18 Vdc to 28 Vdc Signal OFF level: -4 Vdc to +4 Vdc</li> <li>Output: 1 MFDO safety monitor output for external device monitor (EDM)</li> </ul>
Response time from opening the input to stopping the drive output	3 ms or less
Response time from opening H1 and H2 terminal inputs to operating the EDM signal	20 ms or less
Failure probability	Less frequent operation request mode
	Frequent operation request mode or continuous mode
Performance level	The Safe Disable input complies with the performance level requirements of EN ISO 13849-1.
HFT (hardware fault tolerance)	N = 1
Type of subsystem	Type B

EDM = External Device Monitoring

PFH = Probability of Failure on Demand

PFH = Probability of Dangerous Failure per Hour

## ■ Notes

**⚠ DANGER** *Sudden Movement Hazard. Make sure that the full system or machinery in which the Safe Disable function is used complies with safety requirements. When implementing the Safe Disable function into the safety system of a machine, do a full risk assessment for the system to make sure that all parts of the system comply with applicable safety standards. Incorrect application of the Safe Disable function will cause serious injury or death.*

**⚠ DANGER** *Sudden Movement Hazard. An external holding brake or dynamic brake are NOT drive safety components. Systems that use an external holding brake or dynamic brake with a drive output signal (including EDM) are not safe systems because the drive output signal is not a safety component. You must use a system that satisfies the safety requirements. Failure to obey will cause death or serious injury.*

**⚠ DANGER** *Sudden Movement Hazard. Connect the Safe Disable inputs to the devices as specified by the safety requirements. Failure to obey will cause death or serious injury.*

**⚠ WARNING** *Sudden Movement Hazard. With PM motors, the failure of two output transistors can cause current to flow through the motor winding and move the motor output axis 180 electrical degrees. This is possible when the Safe Disable function turns off the drive output. Make sure that output transistors failure will not effect the safety of the application when with the Safe Disable function. Failure to obey could cause death or serious injury.*

**⚠ WARNING** *Electrical Shock Hazard. The Safe Disable function will turn off the drive output, but it will not stop the drive power supply and it cannot electrically isolate the drive output from the input. Always turn off the drive power supply during maintenance and installations on the drive input and output sides. Failure to obey could cause death or serious injury.*

**⚠ WARNING** *Sudden Movement Hazard. An external gravitational force in the vertical axis will move the motor although the Safe Disable function is in operation. Failure to obey could cause serious injury or death.*

**⚠ WARNING** *Sudden Movement Hazard. Remove the pre-installed wire links between terminals H1-HC and H2-HC to use the Safe Disable inputs. Failure to obey will prevent correct operation of the Safe Disable circuit and could cause death or serious injury.*

**⚠ WARNING** *Sudden Movement Hazard. Regularly examine the Safe Disable input and all other safety features. A system that does not operate correctly can cause death or serious injury.*

**⚠ WARNING** *Sudden Movement Hazard. Only let approved technicians with full knowledge of the drive, the instruction manual, and safety standards wire, examine, and maintain the Safe Disable input. Failure to obey could cause death or serious injury.*

**NOTICE** *A maximum of 3 ms will elapse from when terminals H1 or H2 shut off until the drive switches to the "Safe Torque Off" status. Set the OFF status for terminals H1 and H2 to hold for at least 2 ms. The drive may not be able to switch to the "Safe Torque Off" status if terminals H1 and H2 are only open for less than 2 ms.*

**NOTICE** *Only use the Safe Disable Monitor (multi-function output terminal set to the EDM function) to monitor the Safe Disable status or to find a malfunction in the Safe Disable inputs. The monitor output is not a safety output.*

**NOTICE** *Drives that have a built-in safety function must be replaced 10 years after first use.*

## ■ Using the Safe Disable Function

### Safe Disable Circuit

The Safe Disable circuit has two isolated channels (terminals H1 and H2) that stop the output transistors. The input can use the internal power supply of the drive.

Set the EDM function to one of the MFDO terminals [ $H2-xx = 0E$  or  $10E$ ] to monitor the status of the Safe Disable function. This is the "Safe Disable monitor output function".

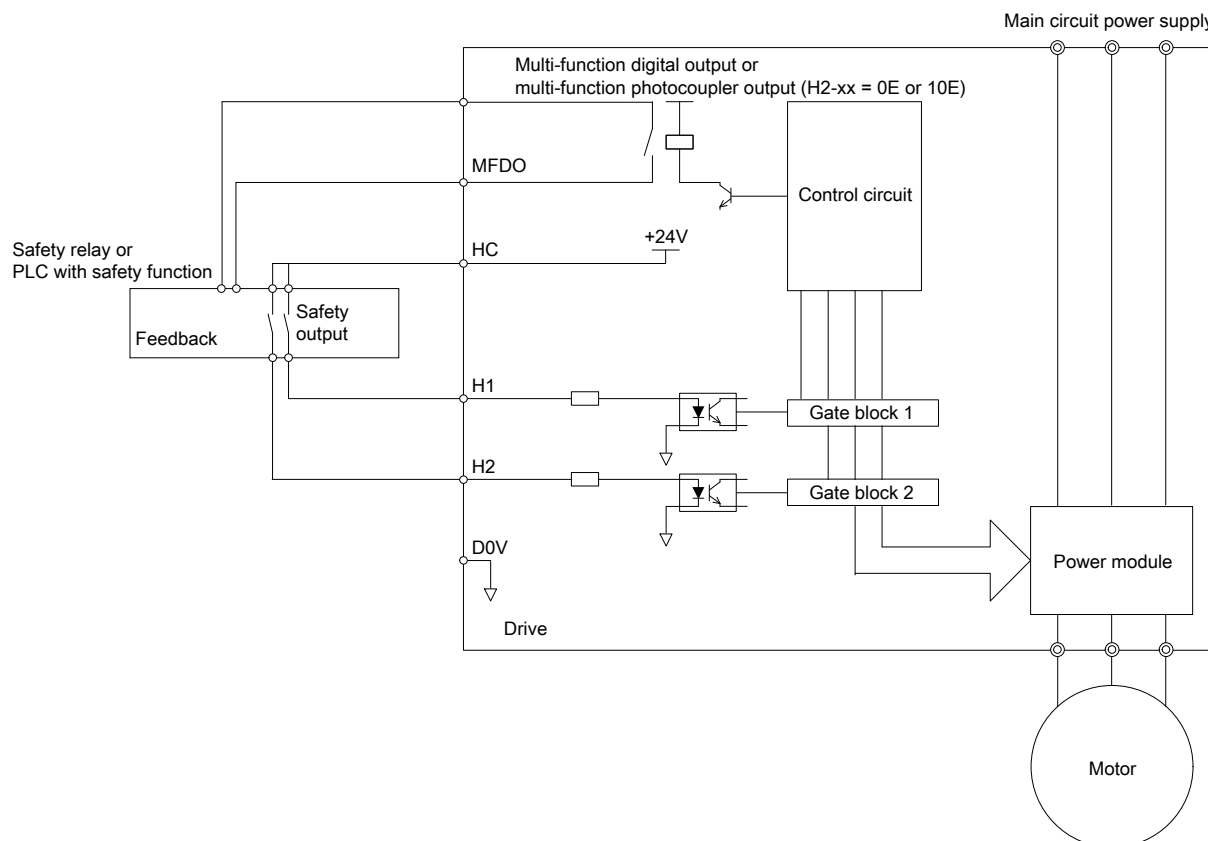

Figure 1.8 Safe Disable Function Wiring Example

### Enabling and Disabling the Drive Output (“Safe Torque Off”)

Example of drive operation when as the drive changes from the "Safe Torque Off" status to usual operation.

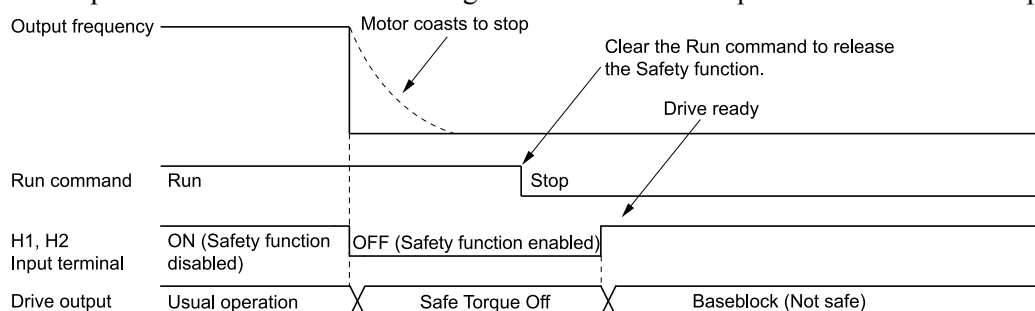

Figure 1.9 Safe Disable Operation

#### Switching from Usual Operation to “Safe Torque Off”

Turn OFF (open) safety input terminal H1 or H2 to enable the Safe Disable function. When the Safe Disable function is enabled while the motor is operating, the drive output and motor torque turn off and the motor always coasts to stop. The *b1-03 [Stopping Method Selection]* setting does not have an effect on the stopping method.

The “Safe Torque Off” status is only possible with the Safe Disable function. Clear the Run command to stop the drive. Turning off drive output (a baseblock condition) ≠ “Safe Torque Off”.

#### Note:

A maximum of 3 ms will elapse from when terminals H1 or H2 shut off until the drive switches to the "Safe Torque Off" status. Set the OFF status for terminals H1 and H2 to hold for at least 2 ms. The drive may not be able to switch to the “Safe Torque Off” status if terminals H1 and H2 are only open for less than 2 ms.

Turn OFF terminals H1 and H2 after the motor fully stops. This will prevent the motor from coasting to stop during usual operation.

#### Going from “Safe Torque Off” to Usual Operation

The safety input will only release when there is no Run command.

- During Stop:  
When the Safe Disable function is triggered during stop, close the circuit between terminals H1-HC and H2-HC to disable “Safe Torque Off”. Enter the Run command after the drive stops correctly.
- During Run:



When the Safe Disable function is triggered during run, close the circuit between terminals H1-HC and H2-HC to disable “Safe Torque Off” after clearing the Run command. Enter the Stop command, then enter the Run command when terminals H1 and H2 are ON or OFF.

### Safe Disable Monitor Output Function and Keypad Display

Information about the relation between the input channel status, Safety monitor output status, and drive output status.

**Table 1.9 Safe Disable Input and External Device Monitor (EDM) Terminal Status**

Input Channel Status		Safety Monitor Output Status		Drive Output Status	Keypad Display	LED Status Ring
Input 1 (H1-HC)	Input 2 (H2-HC)	MFDO Terminal (H2-xx = 0E)	MFDO Terminal (H2-xx = 10E)			
ON (Close the circuit)	ON (Close the circuit)	OFF	ON	Baseblock (Drive ready)	Normally displayed	Ready: Illuminated
OFF (Open)	ON (Close the circuit)	OFF	ON	Safety status (STo)	SToF (Flashing)	ALM/ERR: Flashing
ON (Close the circuit)	OFF (Open)	OFF	ON	Safety status (STo)	SToF (Flashing)	ALM/ERR: Flashing
OFF (Open)	OFF (Open)	ON	OFF	Safety status (STo)	STo (Flashing)	Ready: Flashing

#### Safety Function Status Monitor

The drive Safety monitor output sends a feedback signal about the status of the Safety function. The Safety monitor output is one of the possible settings available for the MFDO terminals. If there is damage to the Safe Disable circuit, a controller (PLC or safety relay) must read this signal as an input signal to hold the “Safe Torque Off” status. This will help verify the condition of the safety circuit. Refer to the manual for the safety device for more information about the Safety function.

It is possible to switch polarity of the Safety monitor output signal with the MFDO function settings.

#### Keypad Display

If the two input channels are OFF (Open), the keypad will flash *STo* [*Safe Torque OFF*].

If there is damage to the Safe disable circuit or the drive, the keypad will flash *SToF* [*Safe Torque OFF Hardware*] when one input channel is OFF (Open), and the other is ON (Short circuit). When you use the Safe disable circuit correctly, the keypad will not show *SToF*.

If there is damage to the drive, the keypad will show *SCF* [*Safety Circuit Fault*] when the drive detects a fault in the Safe disable circuit. Refer to the chapter on Troubleshooting for more information.

#### Validating the Safe Disable Function

After you replace parts or do maintenance on the drive, first complete all necessary wiring to start the drive, then test the Safe Disable input with these steps. Keep a record of the test results.

- When the two input channels are OFF (Open), make sure that the keypad flashes *STo* [*Safe Torque OFF*], and make sure that the motor is not running.
- Monitor the ON/OFF status of the input channels and make sure that MFDO set to the EDM function operates correctly.

If one or more of the these items are true, the ON/OFF status of the MFDO may not display correctly on the keypad:

- Incorrect parameter settings.
- A problem with an external device.
- The external wiring has a short circuit or is disconnected.
- There is damage to the device.

Find the cause and repair the problem to correctly display the status.

- Make sure that the EDM signal operates during usual operation.

## 2 Attachments

### ◆ UL Standards



Figure 2.1 UL/cUL Mark

The UL/cUL Mark indicates that this product satisfies stringent safety standards. This mark appears on products in the United States and Canada. It shows UL approval, indicating that it has been determined that the product complies with safety standards after undergoing strict inspection and assessment. UL-approved parts must be used for all major components that are built into electrical appliances that obtain UL approval.

This product has been tested in accordance with UL standard UL61800-5-1, and has been verified to be in compliance with UL standards.

Machines and devices integrated with this product must satisfy the following conditions for compliance with UL standards.

### ■ Area of Use

Installation Environment	Overvoltage category III and pollution degree 2 or less
Ambient Temperature	UL Type 1 enclosure: -10 °C to +50 °C (14 °F to 122 °F). Derate the output current and output voltage if the drive is installed in areas with ambient temperatures from +40 °C to +50 °C (104 °F to 122 °F). IP20 enclosure: -10 °C to +60 °C (14 °F to 140 °F). Derate the output current and output voltage if the drive is installed in areas with ambient temperatures from +50 °C to +60 °C (122 °F to 140 °F).

### ■ Wire the Main Circuit Terminal Block

Wire the main circuit terminal block correctly as specified by the instructions in the manual.

To comply with UL standards on drive models from 2257 and from 4208, use UL-approved closed-loop crimp terminals. Use the tools recommend by the terminal manufacturer to crimp the closed-loop crimp terminal. Refer to [Closed-Loop Crimp Terminals on page 23](#) for more information about closed-loop crimp terminals (UL-compliant products).

To select the correct wire gauge, refer to [Main Circuit Wire Gauges and Tightening Torques on page 31](#).

### Notes on Wiring the Main Circuit Terminal Block

**Note:**

- Use UL-Listed, vinyl-coated insulated copper wires for operation with a continuous maximum permitted temperature of 75 °C at 600 V
- Remove all unwanted objects that are near the terminal block connections.
- Remove the insulation from the connection wires to the wire stripping lengths shown in the manual.
- Do not use bent or crushed wires. Remove the damaged end of the wire before you use it. Incorrect connections can cause death or serious injury from fire.
- Do not solder stranded wire. Soldered wire connections can become loose over time and cause unsatisfactory drive performance.
- If you use stranded wire, make sure that all of the wire strands are in the connection. Also, do not twist the stranded wire too much. Incorrect connections can cause death or serious injury from fire.
- Put the wire all the way into the terminal block. Remove the insulation from the wire to the recommended wire stripping length to fit the wire with insulation in the plastic housing.
- Use a torque driver, torque ratchet, or torque wrench for the screws. A slotted driver or a hex tool will be necessary to wire the screw clamp terminal. Use applicable tools as specified by the recommended conditions in the product manual.
- If you use power tools to tighten the terminal screws, use a low speed setting (300 to 400 r/min). Failure to obey can cause damage to the terminal screws.
- Wire gauges on existing drive models to be replaced may not match wire gauge ranges on new drives. Refer to the Technical Manual for correct wire gauges.
- Do not tighten the terminal screws at an angle of 5 degrees or more. Failure to obey can cause damage to the terminal screws.

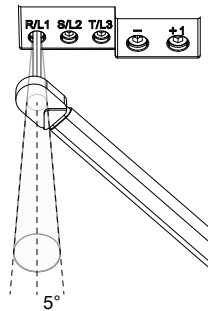

**Figure 2.2 Permitted Angle**

- Put the bit all the way into the hex socket to tighten the hex socket cap screw.
- When tightening slotted screws, hold the straight-edge screwdriver perpendicularly to the screw. Do not allow the tip of the screwdriver to shift or protrude from the groove of the screw.

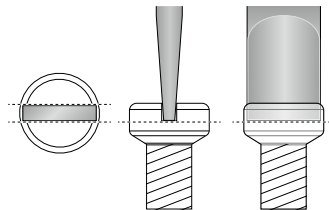

**Figure 2.3 Tightening Slotted Screws**



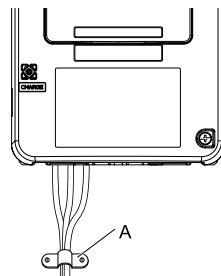



- After connecting the wires to the terminal block, lightly pull on the wires to make sure that they do not come out of the terminals.
- Remove the correct section of the wiring cover to make wiring easier.
- Do not let strain on the wiring cause damage. Use a strain relief near the wiring to release the tension.



**A - Strain relief**

**Figure 2.4 Strain Relief Example**

Table 2.1 Recommended Wiring Tools

Screw	Adapter	Bit		Torque Driver Model (Tightening Torque)	Torque Wrench
		Model	Manufacturer		
 M4	Bit	SF-BIT-SL 1,0X4,0-70	PHOENIX CONTACT	TSD-M 3NM (1.2 - 3 N·m)	-
 M5 *1	Bit	SF-BIT-SL 1,2X6,5-70	PHOENIX CONTACT	Wire Gauge ≤ 25 mm <sup>2</sup> (AWG 10): TSD-M 3NM (1.2 - 3 N·m)	Wire Gauge ≤ 25 mm <sup>2</sup> (AWG 10): -
				Wire Gauge ≥ 30 mm <sup>2</sup> (AWG 8): -	Wire Gauge ≥ 30 mm <sup>2</sup> (AWG 8): 4.1 - 4.5 N·m *2 *3
 M6	Bit	SF-BIT-HEX 5-50	PHOENIX CONTACT	-	5 - 9 N·m *2 *3
 M6	Bit	SF-BIT-SL 1,2X6,5-70	PHOENIX CONTACT	-	3 - 3.5 N·m *2 *3
 M8	Bit	SF-BIT-HEX 6-50	PHOENIX CONTACT	-	8 - 12 N·m *2 *3
 M10	Bit	SF-BIT-HEX 8-50	PHOENIX CONTACT	-	12 - 14 N·m *2 *3

\*1 When wiring drive models 2056 and 4089 and smaller, select the correct tools for the wire gauge.

\*2 Use 6.35 mm (0.25 in) bit socket holder.

\*3 Use a torque wrench that can apply this torque measurement range.

## ■ Closed-Loop Crimp Terminals

To comply with UL standards on drive models from 4208, use UL-approved closed-loop crimp terminals. Use the tools recommend by the terminal manufacturer to crimp the closed-loop crimp terminal. Closed-loop crimp terminals from JST Mfg. Co., Ltd. and insulation caps from Tokyo DIP Co., Ltd. are recommended.

Comply with local standards for correct wire gauges in the region where the drive is used.

Contact the manufacturer or your nearest sales representative to order.

### Note:

To comply with UL standards, use only insulated crimp terminals or crimp terminals with insulation tubing. Use UL-Listed, vinyl-coated insulated copper wires for operation with a continuous maximum permitted temperature of 75 °C at 600 V.

Table 2.2 Closed-Loop Crimp Terminals and Insulation Caps (400 V Class)

Model	Recommended Gauge (AWG, kcmil)					Terminal Screw Size	Crimp Terminal Model	Crimping Tool		Insulation Cap Model
	R/L1 S/L2 T/L3	U/T1 V/T2 W/T3	-, +1	+3	⊕			Tool Model	Die Jaw	
4002, 4004	-	-	-	-	12	M4	R5.5-4	YA-4	AD-900	TP-005
4005 - 4012	-	-	-	-	10	M4	R5.5-4	YA-4	AD-900	TP-005
4018, 4023	-	-	-	-	10	M5	R5.5-5	YA-4	AD-900	TP-005
4031	-	-	-	-	8	M6	R8-6	YA-4	AD-901	TP-008
4038	-	-	-	-	6	M6	R14-6	YA-4	AD-902	TP-014
4044, 4060	-	-	-	-	6	M6	R14-6	YA-4	AD-902	TP-014
4075	-	-	-	-	6	M6	R14-6	YA-4	AD-902	TP-014
4089, 4103	-	-	-	-	4	M6	R22-6	YA-5	AD-953	TP-022
4140, 4168	-	-	-	-	4	M8	R22-8	YA-5	AD-953	TP-022
4208	-	-	-	-	4	M10	R22-10	YF-1 YET-150-1	TD-223, TD-212	TP-022
	1/0 × 2P	1/0 × 2P	-	1/0 × 2P	-		R60-10		TD-225, TD-213	TP-060
	-	-	3/0 × 2P	-	-		80-10		TD-227, TD-214	TP-080

EN

## 2 Attachments

Model	Recommended Gauge (AWG, kcmil)					Terminal Screw Size	Crimp Terminal Model	Crimping Tool		Insulation Cap Model
	R/L1 S/L2 T/L3	U/T1 V/T2 W/T3	- , +1	+3	⊕			Tool Model	Die Jaw	
4250	-	-	-	-	2	M10	R38-10	YF-1 YET-150-1	TD-224, TD-212	TP-038
	-	-	-	1/0 × 2P	-		R60-10		TD-225, TD-213	TP-060
	2/0 × 2P	2/0 × 2P	-	-	-		80-10		TD-227, TD-214	TP-080
	-	-	3/0 × 2P							
4296	-	-	-	-	2	M10	R38-10	YF-1 YET-150-1	TD-224, TD-212	TP-038
	-	-	-	1/0 × 2P	-		R60-10		TD-225, TD-213	TP-060
	3/0 × 2P	3/0 × 2P	-	-	-		80-10		TD-227, TD-214	TP-080
	-	-	4/0 × 2P	-	-		R100-10		TD-228, TD-214	TP-100
4371	-	-	-	-	1	M12	R60-12	YF-1 YET-300-1	TD-321, TD-311	TP-060
	-	-	-	3/0 × 2P	-		80-12		TD-323, TD-312	TP-080
	250 × 2P	250 × 2P	-	-	-		R150-12		TD-325, TD-313	TP-150
	-	-	350 × 2P	-	-		R200-12		TD-327, TD-314	TP-200
4389	-	-	-	-	1	M12	R60-12	YF-1 YET-300-1	TD-321, TD-311	TP-060
	-	-	-	4/0 × 2P	-		R100-12		TD-324, TD-312	TP-100
	300 × 2P	300 × 2P	-	-	-		R150-12		TD-325, TD-313	TP-150
	-	-	400 × 2P	-	-		R200-12		TD-327, TD-314	TP-200
4453	-	-	-	-	1/0	M12	R60-12	YF-1 YET-300-1	TD-321, TD-311	TP-060
	-	-	-	3/0 × 4P	-		80-12		TD-323, TD-312	TP-080
	-	4/0 × 4P	4/0 × 4P	-	-		R100-12		TD-324, TD-312	TP-100
	250 × 4P	-	-	-	-		R150-12		TD-325, TD-313	TP-150
4568	-	-	-	-	2/0	M12	80-12	YF-1 YET-300-1	TD-323, TD-312	TP-080
	-	4/0 × 4P	-	-	-				R100-12	TD-324, TD-312
	250 × 4P	-	-	-	-		R150-12		TD-325, TD-313	TP-150
	-		300 × 4P							
4675	-	-	-	-	2/0	M12	80-12	YF-1 YET-300-1	TD-323, TD-312	TP-080
	-	-	-	4/0 × 4P	-		R100-12		TD-324, TD-312	TP-100
	300 × 4P	300 × 4P	-	-	-		R150-12		TD-325, TD-313	TP-150
	-	-	400 × 4P	-	-		R200-12		TD-327, TD-314	TP-200

### ■ Factory-Recommended Branch Circuit Protection for UL Listing

Use branch circuit protection to protect against short circuits and to maintain compliance with UL61800-5-1. We recommend connecting semiconductor protection fuses on the input side for branch circuit protection. Refer to [Factory Recommended Branch Circuit Protection on page 31](#) for the recommended fuses.



**⚠ WARNING** *Electrical Shock Hazard. Do not immediately energize the drive or operate peripheral devices after the drive blows a fuse or trips an RCM/RCD. Wait for the time specified on the warning label at a minimum and make sure that all indicators are OFF. Then check the wiring and peripheral device ratings to find the cause of the problem. Contact the manufacturer before energizing the drive or peripheral devices if the cause is not known. Failure to obey can cause death or serious injury and damage to the drive.*

- 400 V class

Use the fuses specified in this document to prepare the drive for use on a circuit that supplies not more than 100,000 RMS symmetrical amperes and 480 Vac when there is a short circuit in the power supply.

The built-in short circuit protection of the drive does not provide branch circuit protection. The user must provide branch circuit protection as specified by the National Electric Code (NEC), the Canadian Electric Code, Part I (CEC), and local codes.

## ■ Low Voltage Wiring for Control Circuit Terminals

You must provide low voltage wiring as specified by the National Electric Code (NEC), the Canadian Electric Code, Part I (CEC), and local codes. The NEC class 1 circuit conductor is recommended. Use the UL approved class 2 power supply for external power supply.

**Table 2.3 Control Circuit Terminal Power Supplies**

Input/Output	Terminals	Power Supply Specifications
Digital input	DI1-DI8, DIC, D0V, D24V	Uses the LVLC power supply in the drive. Use the UL Listed class 2 power supply for external power supply.
Analog input	PI, +10V, -10V, AI1, AI2, AI3, A0V	Uses the LVLC power supply in the drive. Use the UL Listed class 2 power supply for external power supply.
Analog output	AO1, AO2, A0V	Uses the LVLC power supply in the drive.
Pulse train output	PO, A0V	Uses the LVLC power supply in the drive. Use the UL Listed class 2 power supply for external power supply.
Pulse train input	PI, A0V	Uses the LVLC power supply in the drive. Use the UL Listed class 2 power supply for external power supply.
Safe disable input	H1, H2, HC	Uses the LVLC power supply in the drive. Use the UL Listed class 2 power supply for external power supply.
Serial communication input/output	RS485+, RS485-, A0V	Uses the LVLC power supply in the drive. Use the UL Listed class 2 power supply for external power supply.
24 V external power supply	E24V, A0V	Use the UL Listed class 2 power supply.

## ■ Drive Motor Overload and Overheat Protection

The drive motor overload and overheat protection function complies with the National Electric Code (NEC) and the Canadian Electric Code, Part I (CEC).

Set the Motor Rated Current and *L1-01 through L1-04 [Motor Overload Protection Select]* correctly to enable motor overload and overheat protection.

Refer to the control method and set the motor rated current with *E2-01 [Motor Rated Current (FLA)]*, *E5-03 [PM Motor Rated Current (FLA)]*, or *E9-06 [Motor Rated Current (FLA)]*.

### E2-01 Mot Rated Current (FLA)

No. (Hex.)	Name	Description	Default (Range)
E2-01 (030E)	Mot Rated Current (FLA)	Sets the motor rated current in amps.	Determined by o2-04 and C6-01 (10% to 200% of the drive rated current)

**Note:**

- If *E2-01 < E2-03 [Mot No-Load Current]* the drive will detect *oPE02 [Parameter Range Setting Error]*.
- The default settings and setting ranges are in these units:  
–0.01 A: 4002 to 4023  
–0.1 A: 4031 to 4675

The value set for *E2-01* becomes the reference value for motor protection, the torque limit, and torque control. Enter the motor rated current as written on the motor nameplate. The value of *E2-01* is automatically set to the value input for “Motor Rated Current” by the Auto-Tuning process.

**E5-03 PM Mot Rated Current (FLA)**

No. (Hex.)	Name	Description	Default (Range)
E5-03 (032B)	PM Mot Rated Current (FLA)	Sets the PM motor rated current (FLA).	Determined by E5-01 (10% to 200% of the drive rated current)

**Note:**

When the drive model changes, the display units for this parameter also change.

- 0.01 A: 4002 to 4023

- 0.1 A: 4031 to 4675

The drive automatically sets *E5-03* to the value input for “PM Motor Rated Current” after you do these types of Auto-Tuning:

- PM Motor Parameter Settings
- PM Stationary Auto-Tuning
- PM StaTun for Stator Resistance
- PM Rotational Auto-Tuning

**E9-06 Motor Rated Current**

No. (Hex.)	Name	Description	Default (Range)
E9-06 (11E9)	Motor Rated Current	Sets the motor rated current in amps.	Determined by E9-01 and o2-04 (10% to 200% of the drive rated current)

**Note:**

When the drive model changes, the display units for this parameter also change.

- 0.01 A: 4002 to 4023

- 0.1 A: 4031 to 4675

The setting value of *E9-06* is the reference value for motor protection. Enter the motor rated current shown on the motor nameplate. Auto-Tuning the drive will automatically set *E9-06* to the value input for “Motor Rated Current”.

**L1-01 Motor Cool Type for OL1 Calc**

No. (Hex.)	Name	Description	Default (Range)
L1-01 (0480)	Motor Cool Type for OL1 Calc	Sets the motor overload protection with electronic thermal protectors.	Determined by A1-02 (1 - 7)

This parameter enables and disables the motor overload protection with electronic thermal protectors.

The cooling capability of the motor changes when the speed control range of the motor changes. Use an electronic thermal protector that aligns with the permitted load characteristics of the motor to select motor protection.

The electronic thermal protector of the drive uses these items to calculate motor overload tolerance and supply overload protection for the motor:

- Output current
- Output frequency
- Motor thermal characteristics
- Time characteristics

If the drive detects motor overload, the drive will trigger an *oL1* [Motor Overload] and stop the drive output.

Set *H2-01 = 1F* [2NO-2CM Func Selection = Motor Overload Alarm (oL1)] to set a motor overload alarm. If the motor overload level is more than 90% of the *oL1* detection level, the output terminal turns ON and triggers an overload alarm.

**1 : Disabled**

Disable motor protection when motor overload protection is not necessary or when the drive is operating more than one motor.

Refer to [Figure 2.5](#) for an example of the circuit configuration to connect more than one motor to one drive.

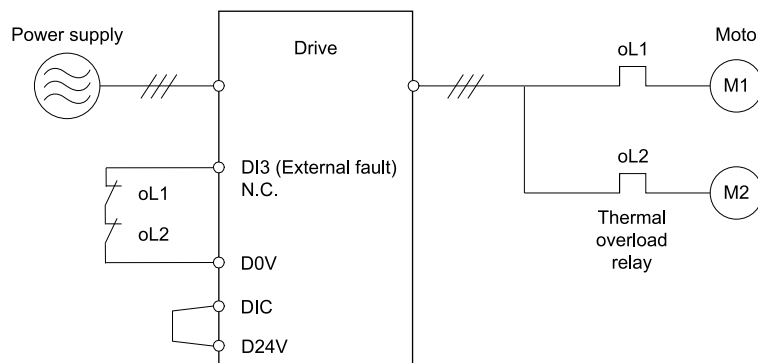

Figure 2.5 Protection Circuit Configuration to Connect More than One Motor to One Drive

**NOTICE** When one drive is operating more than one motor at the same time or when the rated current of the motor is much larger than rated current of a standard motor, you cannot protect the motor with electronic thermal protection. To protect each motor, set L1-01 = 1 [Motor Cool Type for OL1 Calc = Disabled], configure the circuits, then add thermal relays to each motor. The magnetic contactor installed for motor protection cannot be switched ON/OFF during run. Failure to obey can cause motor failure.

### 2 : VTorque

Use this setting for general-purpose motors with a 60 Hz base frequency.

The overload tolerance decreases as motor speed decreases because the cooling fan speed decreases and the ability of the motor to cool decreases in the low speed range.

The overload tolerance characteristics of the motor change the trigger point for the electronic thermal protector. This provides motor overheat protection from low speed to high speed across the full speed range.

Load Tolerance	Cooling Capability	Overload Characteristics (at 100% motor load)
	<p>This motor is designed to operate with commercial line power. Operate at a 60 Hz base frequency to maximize the motor cooling ability.</p>	<p>If the motor operates at frequencies less than 60 Hz, the drive will detect oL1. The drive triggers a fault relay output and the motor coasts to stop.</p>

### 3 : CT 10:1 Speed Range

Use this setting for drive-dedicated motors with a speed range for constant torque of 1:10.

The speed control for this motor is 10% to 100% when at 100% load. Operating slower than 10% speed at 100% load will cause motor overload.

Load Tolerance	Cooling Capability	Overload Characteristics (at 100% motor load)
	<p>This motor is designed to withstand increased temperatures during continuous operation in the low speed range (10% base frequency).</p>	<p>The motor operates continuously at 10% to 100% base frequency. Operating slower than 10% speed at 100% load will cause motor overload.</p>

### 4 : CT 100:1 SpeedRange

## 2 Attachments

Use this setting for vector motors with a speed range for constant torque of 1:100.

The speed control for this motor is 1% to 100% when at 100% load. Operating slower than 1% speed at 100% load will cause motor overload.

Load Tolerance	Cooling Capability	Overload Characteristics (at 100% motor load)
	<p>This motor is designed to withstand increased temperatures during continuous operation in the low speed range (1% base frequency).</p>	<p>The motor operates continuously at 1% to 100% base frequency. Operating slower than 1% speed at 100% load will cause motor overload.</p>

### 5 : PM VTorque

Use this setting for PM motors with derated torque characteristics.

The overload tolerance decreases as motor speed decreases because the cooling fan speed decreases and the ability of the motor to cool decreases in the low speed range.

The overload tolerance characteristics of the motor change the trigger point for the electronic thermal protector. This provides motor overheat protection from low speed to high speed across the full speed range.

Load Tolerance	Cooling Capability	Overload Characteristics (at 100% motor load)
	<p>This motor is designed to withstand increased temperatures during continuous operation at rated speed and rated torque.</p>	<p>If the motor operates continuously at lower speed than rated rotation speed at more than 100% torque, the drive will detect <i>oLI</i>. The drive triggers a fault relay output and the motor coasts to stop.</p>

### 6 : PM CTorque

Use this setting with a PM motor for constant torque that has a speed range for constant torque of 1:500.

The speed control for this motor is 0.2% to 100% when at 100% load. Operating slower than 0.2% speed at 100% load will cause motor overload.

Load Tolerance	Cooling Capability	Overload Characteristics (at 100% motor load)
	<p>This motor is designed to withstand increased temperatures during continuous operation in the low speed range (0.2% base frequency).</p>	<p>The motor operates continuously at 0.2% to 100% rated speed. Operating slower than 0.2% speed at 100% load will cause motor overload.</p>

### 7 : VT (50Hz)

Use this setting for general-purpose motors with a 50 Hz base frequency.

The overload tolerance decreases as motor speed decreases because the cooling fan speed decreases and the ability of the motor to cool decreases in the low speed range.

The overload tolerance characteristics of the motor change the trigger point for the electronic thermal protector. This provides motor overheat protection from low speed to high speed across the full speed range.

Load Tolerance	Cooling Capability	Overload Characteristics (at 100% motor load)
	<p>This motor is designed to operate with commercial line power. Operate at a 50 Hz base frequency to maximize the motor cooling ability.</p>	<p>If the motor operates at frequencies less than commercial line power, the drive will detect <i>oLI</i>. The drive triggers a fault relay output and the motor coasts to stop.</p>

**L1-02 OL1 Protect Time**

No. (Hex.)	Name	Description	Default (Range)
L1-02 (0481)	OL1 Protect Time	Sets the operation time for the electronic thermal protector of the drive to prevent damage to the motor. Usually it is not necessary to change this setting.	1.0 min (0.1 - 5.0 min)

Set the overload tolerance time to the length of time that the motor can operate at 150% load from continuous operation at 100% load.

When the motor operates at 150% load continuously for 1 minute after continuous operation at 100% load (hot start), the default setting triggers the electronic thermal protector.

Figure 2.6 shows an example of the electronic thermal protector operation time. Motor overload protection operates in the range between a cold start and a hot start.

This example shows a general-purpose motor operating at the base frequency with *L1-02* set to 1.0 min.

- Cold start  
Shows the motor protection operation time characteristics when the overload occurs immediately after starting operation from a complete stop.
- Hot start  
Shows the motor protection operation time characteristics when overload occurs from continuous operation below the motor rated current.

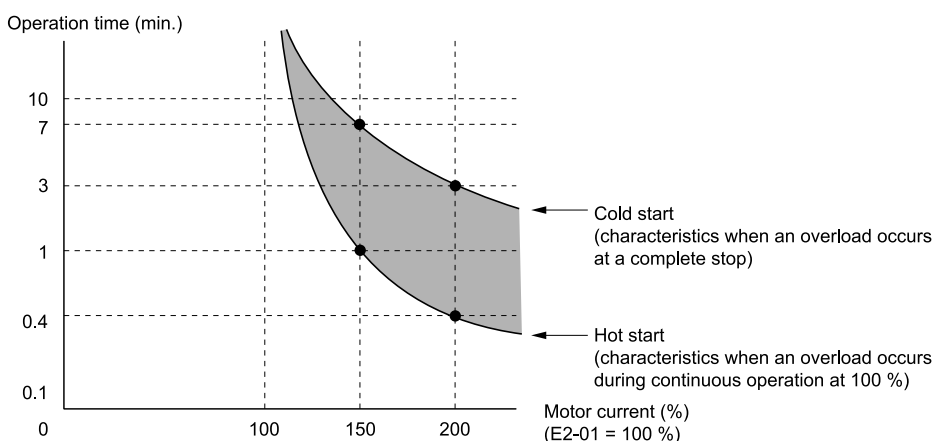

**Figure 2.6 Protection Operation Time for a General-purpose Motor at Rated Output Frequency**

**L1-03 Motor oH AL Reaction Select**

No. (Hex.)	Name	Description	Default (Range)
L1-03 (0482)	Motor oH AL Reaction Select	Sets drive operation when the PTC input signal entered into the drive is at the <i>oH3</i> [Motor Overheat Alarm] detection level.	3 (0 - 3)

**0 : Ramp->Stop**

The drive ramps the motor to stop in the deceleration time. Fault relay output terminal 1NO-1CM turns ON and 1NC-1CM turns OFF.

**1 : Coast->Stop**

## 2 Attachments

The output turns OFF and the motor coasts to stop. Fault relay output terminal 1NO-1CM turns ON, and 1NC-1CM turns OFF.

### 2 : Fast Stop (C1-09)

The drive stops the motor in the deceleration time set in *C1-09 [Fast Stop Time]*. Fault relay output terminal 1NO-1CM turns ON, and 1NC-1CM turns OFF.

### 3 : Alarm Only

The keypad shows *oH3*, and operation continues. The output terminal set for *Alarm [H2-01 to H2-03 = 10]* turns ON.

#### L1-04 Motor oH FLT Reaction Select

No. (Hex.)	Name	Description	Default (Range)
L1-04 (0483)	Motor oH FLT Reaction Select	Sets the drive operation when the PTC input signal to the drive is at the <i>oH4 [Motor Overheat Fault (PTC Input)]</i> detection level.	1 (0 - 2)

### 0 : Ramp->Stop

The drive ramps the motor to stop in the deceleration time. Fault relay output terminal 1NO-1CM turns ON and 1NC-1CM turns OFF.

### 1 : Coast->Stop

The output turns OFF and the motor coasts to stop. Fault relay output terminal 1NO-1CM turns ON, and 1NC-1CM turns OFF.

### 2 : Fast Stop (C1-09)

The drive stops the motor in the deceleration time set in *C1-09 [Fast Stop Time]*. Fault relay output terminal 1NO-1CM turns ON, and 1NC-1CM turns OFF.

## ◆ China RoHS Compliance



Figure 2.7 China RoHS Mark

The China RoHS mark is displayed on products containing six specified hazardous substances that are in excess of regulatory limits, based on the “Administrative Measures for the Restriction of the Use of Hazardous Substances in Electrical and Electronic Products” and “Marking for the Restricted Use of Hazardous Substances in Electronic and Electrical Products” (SJ/T 11364-2014), which were promulgated on January 26, 2016. The number displayed in the center of the mark indicates the environment-friendly use period (number of years) in which electrical and electronic products that are being produced, sold, or imported to China can be used. The date of manufacture of the electrical and electronic product is the starting date of the environment-friendly use period for the product. The six specified hazardous substances contained in the product will not leak outside of the product during normal use within this period and will have no serious impact on the environment, the human body, or property.

The environment-friendly use period for this product is 15 years. This period is not the product warranty period.

Table 2.4 Contents of Hazardous Substances in This Product

Parts Name	Hazardous Substances					
	Lead (Pb)	Mercury (Hg)	Cadmium (Cd)	Hexavalent Chromium (Cr(VI))	Polybrominated Biphenyls (PBB)	Polybrominated Diphenyl Ethers (PBDE)
Circuit Board	×	○	○	○	○	○
Electronic Parts	×	○	○	○	○	○
Brass Screw	×	○	○	○	○	○
Aluminum Die Casting	×	○	○	○	○	○

This table has been prepared in accordance with the provisions outlined in SJ/T 11364.

○: Indicates that said hazardous substance contained in all of the homogeneous materials for this part is below or equal to the limit requirement of GB/T 26572.

×: Indicates that said hazardous substance contained in at least one of the homogeneous materials used for this part is above the limit requirement of GB/T 26572.

**Note:**

This product complies with EU RoHS directives. In this table, "×" indicates that hazardous substances that are exempt from EU RoHS directives are contained.

## ◆ 对应中国RoHS指令



图 2.8 中国RoHS标志

中国RoHS标志依据2016年1月26日公布的《电器电子产品有害物质限制使用管理办法》，以及《电子电气产品有害物质限制使用标识要求》（SJ/T 11364-2014）作成。电子电气产品中特定6种有害物质的含量超过规定值时，应标识此标志。中间的数字为在中国生产销售以及进口的电子电气产品的环保使用期限（年限）。电子电气产品的环保使用期限从生产日期算起。在期限内，正常使用产品的过程中，不会有特定的6种有害物质外泄进而对环境、人和财产造成深刻影响。

本产品的环保使用期限为15年。但需要注意的是环保使用期限并非产品的质量保证期限。

表 2.5 本产品中有害物质的名称及含量

部件名称	有害物质					
	铅(Pb)	汞(Hg)	镉(Cd)	六价铬(Cr(VI))	多溴联苯(PBB)	多溴二苯醚(PBDE)
实装基板	×	○	○	○	○	○
电子元件	×	○	○	○	○	○
黄铜螺钉	×	○	○	○	○	○
铝压铸	×	○	○	○	○	○

本表格依据SJ/T 11364的规定编制。  
 ○：表示该有害物质在该部件所有均质材料中的含量均在GB/T 26572规定的限量要求以下。  
 ×：表示该有害物质至少在该部件的某一均质材料中的含量超出GB/T 26572规定的限量要求。  
 （注） 本产品符合欧盟RoHS指令。上表中的“×”表示含有欧盟RoHS指令豁免的有害物质。

## ◆ Factory Recommended Branch Circuit Protection

Table 2.6 Factory-Recommended Branch Circuit Protection (400 V Class)

Drive Model	Semiconductor Protection Fuse Rated Current Manufacturer: EATON/Bussmann	Drive Model	Semiconductor Protection Fuse Rated Current Manufacturer: EATON/Bussmann
4002	FWH-50B	4103	FWH-275A
4004	FWH-50B	4140	FWH-300A
4005	FWH-50B	4168	FWH-325A FWH-400A <sup>*1</sup>
4007	FWH-60B	4208	FWH-500A
4009	FWH-60B	4250	FWH-600A
4012	FWH-60B	4296	FWH-700A
4018	FWH-80B	4371	FWH-800A
4023	FWH-90B	4389	FWH-1000A
4031	FWH-150B	4453	FWH-1200A
4038	FWH-200B	4568	FWH-1200A
4044	FWH-200B	4675	FWH-1400A FWH-1600A <sup>*1</sup>
4060	FWH-225A		
4075	FWH-250A		
4089	FWH-275A		

\*1 A fuse with a large rated current for applications with repeated loads is recommended.

## ◆ Main Circuit Wire Gauges and Tightening Torques

Symbol	Screw
	Hex bolt, cross-slotted
	Hex bolt, slotted



























Symbol	Screw
	Hex self locking nut
	Hex socket cap

## 2 Attachments

































Symbol	Screw
	Philips/slot combo

Symbol	Screw
	Slot































### ■ Three-Phase 400 V Class













Model	Terminals	Recommended Gauge	Applicable Gauge	Wire Stripping Length <sup>*2</sup>	Terminal Screw	Tightening Torque
		mm <sup>2</sup> (AWG kcmil)	IP20 <sup>*1</sup> mm <sup>2</sup> (AWG kcmil)			mm
4002 4004 4005 4007 4009 4012	R/L1, S/L2, T/L3 U/T1, V/T2, W/T3	2.5 (14)	2.5 - 10 (14 - 6)	10	 M4	1.5 - 1.7 (13.5 - 15)
	-, +1, +2	2.5 (14)	2.5 - 16 (14 - 3)	18	 M5	2.3 - 2.5 (19.8 - 22) <sup>*3</sup>
	B1, B2	2.5 (14)	2.5 - 4 (14 - 6)	10	 M4	1.5 - 1.7 (13.5 - 15)
		2.5 <sup>*4</sup> (10)	2.5 - 10 (14 - 6)	-	 M4	1.2 - 1.5 (10.6 - 13.3)
4018	R/L1, S/L2, T/L3 U/T1, V/T2, W/T3	2.5 (10)	2.5 - 10 (14 - 6)	10	 M4	1.5 - 1.7 (13.5 - 15)
	-, +1, +2	4 (8)	2.5 - 16 (14 - 3)	18	 M5	2.3 - 2.5 (19.8 - 22) <sup>*3</sup>
	B1, B2	2.5 (14)	2.5 - 4 (14 - 6)	10	 M4	1.5 - 1.7 (13.5 - 15)
		2.5 <sup>*4</sup> (10)	2.5 - 10 (12 - 8)	-	 M5	2.0 - 2.5 (17.7 - 22.1)
4023	R/L1, S/L2, T/L3	6 (8)	2.5 - 10 (14 - 6)	10	 M4	1.5 - 1.7 (13.5 - 15)
	U/T1, V/T2, W/T3	4 (10)	2.5 - 10 (14 - 6)	10	 M4	1.5 - 1.7 (13.5 - 15)
	-, +1, +2	6 (8)	2.5 - 16 (14 - 3)	18	 M5	2.3 - 2.5 (19.8 - 22) <sup>*3</sup>
	B1, B2	2.5 (12)	2.5 - 4 (14 - 10)	10	 M4	1.5 - 1.7 (13.5 - 15)
		6 <sup>*4</sup> (10)	4 - 10 (12 - 8)	-	 M5	2.0 - 2.5 (17.7 - 22.1)
4031	R/L1, S/L2, T/L3	10 (6)	10 - 25 (8 - 3)	18	 M5	2.3 - 2.5 (19.8 - 22) <sup>*3</sup>
	U/T1, V/T2, W/T3	6 (8)	6 - 16 (10 - 4)	18	 M5	2.3 - 2.5 (19.8 - 22) <sup>*3</sup>
	-, +1, +2	10 (6)	10 - 35 (8 - 1)	20	 M6	5 - 5.5 (45 - 49)
	B1, B2	2.5 (10)	2.5 - 10 (14 - 8)	10	 M4	1.5 - 1.7 (13.5 - 15)
		10 (8)	6 - 16 (10 - 6)	-	 M6	5.4 - 6.0 (47.8 - 53.1)
4038	R/L1, S/L2, T/L3	10 (6)	10 - 25 (8 - 3)	18	 M5	2.3 - 2.5 (19.8 - 22) <sup>*3</sup>
	U/T1, V/T2, W/T3	6 (8)	6 - 16 (10 - 4)	18	 M5	2.3 - 2.5 (19.8 - 22) <sup>*3</sup>
	-, +1, +2	16 (4)	10 - 35 (8 - 1)	20	 M6	5 - 5.5 (45 - 49)
	B1, B2	4 (10)	2.5 - 10 (14 - 8)	10	 M4	1.5 - 1.7 (13.5 - 15)
		10 (6)	6 - 16 (10 - 6)	-	 M6	5.4 - 6.0 (47.8 - 53.1)



Model	Terminals	Recommended Gauge	Applicable Gauge	Wire Stripping Length *2	Terminal Screw	Tightening Torque
			IP20 *1			N-m (lb.-in.)
		mm <sup>2</sup> (AWG kcmil)	mm <sup>2</sup> (AWG kcmil)	mm		
4044	R/L1, S/L2, T/L3	16 (4)	4 - 16 (10 - 4)	18	 M5	2.3 - 2.5 (19.8 - 22) *3
	U/T1, V/T2, W/T3	10 (6)	6 - 10 (10 - 6)	18	 M5	2.3 - 2.5 (19.8 - 22) *3
	-, +1, +2	25 (3)	6 - 25 (10 - 3)	18	 M5	2.3 - 2.5 (19.8 - 22) *3
	B1, B2	6 (8)	2.5 - 6 (14 - 8)	10	 M4	1.5 - 1.7 (13.5 - 15)
		16 (6)	10 - 25 (8 - 4)	-	 M6	5.4 - 6.0 (47.8 - 53.1)
4060	R/L1, S/L2, T/L3	16 (4)	4 - 16 (10 - 4)	18	 M5	2.3 - 2.5 (19.8 - 22) *3
	U/T1, V/T2, W/T3	16 (4)	6 - 16 (8 - 4)	18	 M5	2.3 - 2.5 (19.8 - 22) *3
	-, +1	25 (3)	6 - 25 (10 - 3)	18	 M5	2.3 - 2.5 (19.8 - 22) *3
	B1, B2	10 (8)	2.5 - 10 (14 - 8)	10	 M4	1.5 - 1.7 (13.5 - 15)
		16 (6)	10 - 25 (8 - 4)	-	 M6	5.4 - 6.0 (47.8 - 53.1)
4075	R/L1, S/L2, T/L3 U/T1, V/T2, W/T3	25 (3)	2.5 - 25 (12 - 3)	18	 M5	2.3 - 2.5 (19.8 - 22) *3
	-, +1	25 (2)	4 - 25 (10 - 2)	18	 M5	2.3 - 2.5 (19.8 - 22) *3
	B1, B2	10 (6)	2.5 - 10 (14 - 6)	10	 M4	1.5 - 1.7 (13.5 - 15)
		16 (6)	16 - 25 (6 - 4)	-	 M6	5.4 - 6.0 (47.8 - 53.1)
4089	R/L1, S/L2, T/L3 U/T1, V/T2, W/T3	25 (2)	10 - 25 (10 - 2)	18	 M5	2.3 - 2.5 (19.8 - 22) *3
	-, +1	35 (1/0)	16 - 35 (6 - 1/0)	20	 M6	5 - 5.5 (45 - 49)
	B1, B2	16 (6)	4 - 16 (14 - 6)	18	 M5	2.3 - 2.5 (19.8 - 22) *3
		16 (4)	16 - 25 (6 - 4)	-	 M6	5.4 - 6.0 (47.8 - 53.1)
4103	R/L1, S/L2, T/L3 U/T1, V/T2, W/T3	35 (1/0)	50 (2 - 2/0)	27	 M6	8 - 9 (71 - 80)
	-, +1	50 (2/0)	50 - 70 (2 - 4/0)	27	 M8	10 - 12 (89 - 107)
	B1, B2	25 (3)	6 - 35 (10 - 3)	21	 M6	3 - 3.5 (27 - 31)
		16 (4)	16 - 25 (6 - 4)	-	 M6	5.4 - 6.0 (47.8 - 53.1)
4140	R/L1, S/L2, T/L3 U/T1, V/T2, W/T3	50 (3/0)	95 (2/0 - 250)	37	 M10	12 - 14 (107 - 124)
	-, -, +1, +1 *5	25 (2)	50 (1/0 - 2/0)	28	 M6	8 - 9 (71 - 80)
	B1, B2 *6	50 (1)	50 - 70 (1 - 2/0)	28	 M8	8 - 9 (71 - 80)
		25 (4)	25 - 50 (4 - 1/0)	-	 M8	9.0 - 11 (79.7 - 97.4)

## 2 Attachments

Model	Terminals	Recommended Gauge	Applicable Gauge	Wire Stripping Length *2	Terminal Screw	Tightening Torque
			IP20 *1			N·m (lb·in.)
		mm <sup>2</sup> (AWG kcmil)	mm <sup>2</sup> (AWG kcmil)	mm		
4168	R/L1, S/L2, T/L3 U/T1, V/T2, W/T3	70 (4/0)	95 (2/0 - 250)	37	 M10	12 - 14 (107 - 124)
	- , +1, +1 *5	35 (1/0)	50 (1/0 - 2/0)	28	 M6	8 - 9 (71 - 80)
	B1, B2 *6	50 (1/0)	50 - 70 (1 - 2/0)	28	 M8	8 - 9 (71 - 80)
		35 (4)	25 - 50 (4 - 1/0)	-	 M8	9.0 - 11 (79.7 - 97.4)
4208	R/L1, S/L2, T/L3 U/T1, V/T2, W/T3	50 × 2P (1/0 × 2P)	70 - 95 × 2P (2/0 - 4/0 × 2P)	-	 M10	20 (177)
	- , +1	70 × 2P (3/0 × 2P)	120 × 2P (4/0 - 250 × 2P)	-	 M10	20 (177)
	+3	35 × 2P (1/0 × 2P)	70 × 2P (1/0 × 2P)	-	 M10	20 (177)
		50 (4)	50 - 240 (4 - 350)	-	 M10	18 - 23 (159 - 204)
4250	R/L1, S/L2, T/L3 U/T1, V/T2, W/T3	50 × 2P (2/0 × 2P)	70 - 95 × 2P (2/0 - 4/0 × 2P)	-	 M10	20 (177)
	- , +1	70 × 2P (3/0 × 2P)	120 × 2P (4/0 - 250 × 2P)	-	 M10	20 (177)
	+3	50 × 2P (1/0 × 2P)	70 × 2P (1/0 × 2P)	-	 M10	20 (177)
		70 (2)	70 - 240 (2 - 350)	-	 M10	18 - 23 (159 - 204)
4296	R/L1, S/L2, T/L3 U/T1, V/T2, W/T3	70 × 2P (3/0 × 2P)	70 - 95 × 2P (2/0 - 4/0 × 2P)	-	 M10	20 (177)
	- , +1	95 × 2P (4/0 × 2P)	120 × 2P (4/0 - 250 × 2P)	-	 M10	20 (177)
	+3	70 × 2P (1/0 × 2P)	70 × 2P (1/0 × 2P)	-	 M10	20 (177)
		95 (2)	95 - 240 (2 - 350)	-	 M10	18 - 23 (159 - 204)
4371	R/L1, S/L2, T/L3 U/T1, V/T2, W/T3	120 × 2P (250 × 2P)	150 × 2P (250 - 300 × 2P)	-	 M12	35 (310)
	- , +1	120 × 2P (250 × 2P)	185 × 2P (300 - 400 × 2P)	-	 M12	35 (310)
	+3	70 × 2P (3/0 × 2P)	50 - 95 × 2P (1 - 4/0 × 2P)	-	 M12	35 (310)
		120 (1)	120 - 240 (1 - 350)	-	 M12	32 - 40 (283 - 354)
4389	R/L1, S/L2, T/L3 U/T1, V/T2, W/T3	120 × 2P (300 × 2P)	150 × 2P (250 - 300 × 2P)	-	 M12	35 (310)
	- , +1	120 × 2P (400 × 2P)	185 × 2P (300 - 400 × 2P)	-	 M12	35 (310)
	+3	95 × 2P (4/0 × 2P)	50 - 95 × 2P (1 - 4/0 × 2P)	-	 M12	35 (310)
		95 (1)	35 - 240 (1 - 350 × 2P)	-	 M12	32 - 40 (283 - 354)

Model	Terminals	Recommended Gauge	Applicable Gauge	Wire Stripping Length <sup>*2</sup>	Terminal Screw	Tightening Torque
			IP20 <sup>*1</sup>			N·m (lb·in.)
		mm <sup>2</sup> (AWG kcmil)	mm <sup>2</sup> (AWG kcmil)	mm		
4453	R/L1, S/L2, T/L3 R1/L11, S1/L21, T1/L31	120 × 4P (250 × 4P)	150 × 4P (250 - 300 × 4P)	-	 M12	35 (310)
	U/T1, V/T2, W/T3	95 × 4P (4/0 × 4P)	120 - 150 × 4P (250 - 300 × 4P)	-	 M12	35 (310)
	-, +1	95 × 4P (4/0 × 4P)	185 × 4P (300 - 400 × 4P)	-	 M12	35 (310)
	+3	70 × 4P (3/0 × 4P)	95 × 4P (4/0 × 4P)	-	 M12	35 (310)
		150 (1/0)	50 - 150 (1/0 - 300)	-	 M12	32 - 40 (283 - 354)
4568 4675	R/L1, S/L2, T/L3 R1/L11, S1/L21, T1/L31	120 × 4P (250 × 4P)	150 × 4P (250 - 300 × 4P)	-	 M12	35 (310)
	U/T1, V/T2, W/T3	95 × 4P (4/0 × 4P)	120 - 150 × 4P (250 - 300 × 4P)	-	 M12	35 (310)
	-, +1	95 × 4P (300 × 4P)	185 × 4P (300 - 300 × 4P)	-	 M12	35 (310)
	+3	70 × 4P (3/0 × 4P)	95 × 4P (4/0 × 4P)	-	 M12	35 (310)
		95 × 2P (2/0)	60 - 150 (2/0 - 300)	-	 M12	32 - 40 (283 - 354)

\*1 For IP20 protection, use wires that are in the range of applicable gauges. If your installation does not need IP20 protection, smaller cables can be used.

\*2 Remove insulation from the ends of wires to expose the length of wire shown.

\*3 For wire gauges more than 30 mm<sup>2</sup>, tighten to a tightening torque of 4.1 N·m to 4.5 N·m (36 lb·in. to 40 lb·in.).

\*4 Install an RCM/RCD with this wire gauge to maintain compliance with IEC/EN 61800-5-1:2007.

\*5 Terminals - and +1 have two screws. The Recommended Gauge is the wire gauge for one terminal.

\*6 A junction terminal is necessary to connect a braking resistor unit (LKEB-series) to terminals B1 and B2.

# EU Declaration of Conformity

# YASKAWA

Translation – German | French | Italian | Spanish | Portugese

EG-Konformitätserklärung | Déclaration de conformité CE  
 Dichiarazione di conformità CE | Declaración de Conformidad de la CE  
 Declaração de Conformidade CE

**YASKAWA Europe GmbH**  
 Hauptstraße 185  
 65760 Eschborn

**declares under sole responsibility conformity of the following products**

erklärt in alleiniger Verantwortung die Konformität für folgende Produkte  
 déclare, sous sa seule responsabilité, que-les produits  
 dichiara sotto la propria esclusiva responsabilità la conformità dei seguenti prodotti  
 bajo su exclusiva responsabilidad la conformidad para los siguientes productos  
 declara, sob a sua exclusiva responsabilidade, a conformidade dos seguintes produtos

Model: CIPR-GA70 □ □ □ □ □ □ □ □ - □ □ □ □ □ □

**Directive of the European Parliament and Council**

Richtlinie des Europäischen Parlamentes und Rates / Directive du Parlement européen et du Conseil  
 Direttiva del Parlamento europeo e del Consiglio / Directiva del Parlamento Europeo y del Consejo /  
 Diretiva do Parlamento Europeu e do Conselho

**Low Voltage Directive (LVD)**

Niederspannungsrichtlinie / Directive Basse Tension  
 Direttiva sulla bassa tensione / Directiva de Baja Tensión / Diretiva "Baixa Tensão"

: 2014/35/EU

**Electromagnetic Compatibility Directive (EMC)**

EMV-Richtlinie / Directive CEM  
 Direttiva EMC / Directiva sobre Compatibilidad Electromagnética / Diretiva CEM

: 2014/30/EU

**Machine Directive (MD)**

Maschinenrichtlinie / Directive machines  
 Direttiva Macchine / Directiva de Máquinas / Directiva de máquinas

: 2006/42/EC

**Restriction of the use of certain Hazardous Substances (RoHS)**

Beschränkung der Verwendung bestimmter gefährlicher Stoffe in Elektro- und Elektronikgeräten.  
 Relative à la limitation de l'utilisation de certaines substances dangereuses dans les équipements électriques et électroniques.  
 Sulla restrizione dell'uso di determinate sostanze pericolose nelle apparecchiature elettriche ed elettroniche.  
 Sobre restricciones a la utilización de determinadas sustancias peligrosas en aparatos eléctricos y electrónicos.  
 Relativa à restrição do uso de determinadas substâncias perigosas em equipamentos eléctricos e electrónicos.

: 2011/65/EU

**Applied harmonized Standards:**

EN 62061:2005/A1:2015 (SILCL3)  
 EN ISO 13849-1:2015 (Cat.3, PL d)  
 EN 61800-5-2:2007 (SIL3)  
 EN 61800-5-1:2007

EN 50581:2012  
 EN 61000-6-2:2005  
 EN 61000-6-4:2007/A1:2011  
 EN 61800-3:2004/A1:2012

**Place / Date**

Ort, Datum / Lieu et date / Luogo, data / Lugar, Fecha / Local, data

**YASKAWA Europe GmbH**

Hauptstraße 185  
 65760 Eschborn

March 23<sup>rd</sup> , 2018

General Manager  
 European Technology Center  
 Drives and Motion Division

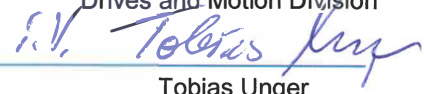

Tobias Unger

# EU Declaration of Conformity

# YASKAWA

Translation – Dutch | Irish | Greek | Bulgarian | Romanian

EG-conformiteitsverklaring | Dearbhú Comhréireachta AE  
 Δήλωση Συμμόρφωσης ΕΚ | ΕΟ-Декларация за съответствие  
 Declarație de conformitate CE

**YASKAWA Europe GmbH**  
 Hauptstraße 185  
 65760 Eschborn

## declares under sole responsibility conformity of the following products

verklaart onder eigen verantwoordelijkheid de conformiteit van de volgende producten  
 a dhearbhaíonn faoi fhreagracht aonair comhréireacht na dtáirgí seo a leanas  
 επιβεβαιώνει, με αποκλειστική του ευθύνη, τη συμμόρφωση των ακόλουθων προϊόντων  
 декларира на собствена отговорност съответствието на следния продукт  
 declară pe răspunderea sa exclusivă conformitatea următoarelor produse

Model: CIPR-GA70 □ □ □□ □ □ □ □ - □□□□□□

## Directive of the European Parliament and Council

Richtlijn van het Europese Parlement en de Europese Raad  
 Treoir ó Pharlaimint na hEorpa agus ón gComhairle / Οδηγία του Ευρωπαϊκού Κοινοβουλίου και του Συμβουλίου  
 Директива на Европейския парламент и Съвета / Directiva Parlamentului European și a Consiliului

### Low Voltage Directive (LVD)

: 2014/35/EU

Laagspanningsrichtlijn / Treoir maidir le hÍsealvoltas  
 Οδηγία για τη χαμηλή τάση / Директивата за ниско напрежение  
 Directive voltaj scăzut

### Electromagnetic Compatibility Directive (EMC)

: 2014/30/EU

EMC-richtlijn / Treoir maidir le Comhoiriúnacht Leictreamaighnéadach  
 Οδηγία ηλεκτρομαγνητικής συμβατότητας (EMC) / Директива за електромагнитна съвместимост  
 Directive CEM

### Machine Directive (MD)

: 2006/42/EC

Machinerichtlijn / Treoir maidir le hInnill (MD)  
 Οδηγία για τα μηχανήματα / Директива Машини (DM) / Directiva mașinărie

### A Restriction of the use of certain hazardous substances (RoHS)

: 2011/65/EU

Betreffende beperking van het gebruik van bepaalde gevaarlijke stoffen in elektrische en elektronische apparatuur.  
 για τον περιορισμό της χρήσης ορισμένων επικίνδυνων ουσιών σε ηλεκτρικό και ηλεκτρονικό εξοπλισμό.  
 относно ограничението за употребата на определени опасни вещества в електрическото и електронното оборудване.  
 Privind restricțiile de utilizare a anumitor substanțe periculoase în echipamentele electrice și electronice.

## Applied harmonized Standards:

EN 62061:2005/A1:2015 (SILCL3)  
 EN ISO 13849-1:2015 (Cat.3, PL d)  
 EN 61800-5-2:2007 (SIL3)  
 EN 61800-5-1:2007

EN 50581:2012  
 EN 61000-6-2:2005  
 EN 61000-6-4:2007/A1:2011  
 EN 61800-3:2004/A1:2012

## Place / Date

Plaats, Datum / Áit, Dáta / Τόπος, ημερομηνία / Място, Дата / Locul, data

**YASKAWA Europe GmbH**

Hauptstraße 185  
 65760 Eschborn

March 23<sup>rd</sup>, 2018

General Manager  
 European Technology Center  
 Drives and Motion Division

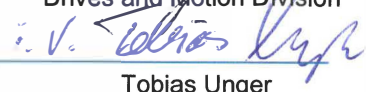

Tobias Unger

# EU Declaration of Conformity

# YASKAWA

Translation – Polish | Lithuanian | Czech | Slovak | Hungarian

Deklaracja zgodności WE | EB atitikties deklaracija  
 ES Prohlášení o shodě | Vyhlásenie o zhode ES  
 EK megfeleléségi nyilatkozat

**YASKAWA Europe GmbH**  
 Hauptstraße 185  
 65760 Eschborn

## declares under sole responsibility conformity of the following products

oświadcza z wyłączną odpowiedzialnością, że niżej wymienione wyroby są zgodne z odpowiednimi przepisami unijnymi  
 prisimdamą atsakomybę patvirtina toliau nurodytų gaminių atitikį  
 Prohlašuje na svou výhradní odpovědnost shodu níže uvedených výrobků  
 potvrdzuje výlučnú zodpovednosť za zhodu pre nasledujúce výrobky  
 saját kizárólagos felelősségére kijelenti, hogy a következő termékek megfelelnek az alábbiakban megfogalmazott követelményeknek

Model: CIPR-GA70 □ □ □ □ □ □ □ □ - □ □ □ □ □ □

## Directive of the European Parliament and Council

Dyrektywa Parlamentu Europejskiego i Rady / Europos Parlamento ir Tarybos direktyva  
 Směrnice Evropského parlamentu a Rady / Smernice Európskeho parlamentu a Rady  
 Az Európai Parlament és az Európai Tanács irányelve

### Low Voltage Directive (LVD)

: 2014/35/EU

Dyrektywa dot. niskich napięć / Žemos įtampos direktyva  
 Směrnice o zařízeních nízkého napětí / Smernica o nízkom napätí  
 Kisfeszültségről szóló irányelv

### Electromagnetic Compatibility Directive (EMC)

: 2014/30/EU

Dyrektywa EMC / EMS direktyva / Směrnice o elektromagnetické kompatibilitě  
 Smernica EMC / Elektromágneses összeférhetőségről szóló irányelv

### Machine Directive (MD)

: 2006/42/EC

Dyrektywa w sprawie maszyn / Direktyva dėl mašinų  
 Směrnice o strojních zařízeních / Smernica o strojových zariadeniach / Gépekről szóló irányelv

### Restriction of the use of certain hazardous substances (RoHS)

: 2011/65/EU

W sprawie ograniczenia stosowania niektórych niebezpiecznych substancji w sprzęcie elektrycznym i elektronicznym.  
 Dėl tam tikrų pavojingų medžiagų naudojimo elektros ir elektroninėje įrangoje apribojimo.  
 O omezení používání některých nebezpečných látek v elektrických a elektronických zařízeních.  
 O obmedzení používania určitých nebezpečných látok v elektrických a elektronických zariadeniach.  
 Egyes veszélyes anyagok elektromos és elektronikus berendezésekben való alkalmazásának korlátozásáról.

### Applied harmonized Standards:

EN 62061:2005/A1:2015 (SILCL3)  
 EN ISO 13849-1:2015 (Cat.3, PL d)  
 EN 61800-5-2:2007 (SIL3)  
 EN 61800-5-1:2007

EN 50581:2012  
 EN 61000-6-2:2005  
 EN 61000-6-4:2007/A1:2011  
 EN 61800-3:2004/A1:2012

### Place / Date

Miejscowość, data / Vieta, data / Místo, datum / Miesto, dátum / Hely, dátum

**YASKAWA Europe GmbH**  
 Hauptstraße 185  
 65760 Eschborn

March 23<sup>rd</sup>, 2018

General Manager  
 European Technology Center  
 Drives and Motion Division

*Tobias Unger*  
 Tobias Unger

# EU Declaration of Conformity

# YASKAWA

Translation - Danish | Swedish | Finnish | Latvian | Estonian

EF-overensstemmelseserklæring | EG-försäkran om överensstämmelse  
EY-vaatimustenmukaisuusvakuutus | EK atbilstības deklarācija  
EÜ vastavusdeklaratsioon

**YASKAWA Europe GmbH**  
Hauptstraße 185  
65760 Eschborn

## declares under sole responsibility conformity of the following products

erklærer som eneste ansvarlig overensstemmelsen for følgende produkter  
försäkrar på eget ansvar att följande produkter uppfyller kraven på överensstämmelse  
vakuuttaa yksinomaisella vastuullaan seuraavien tuotteiden vaatimustenmukaisuuden  
uz savu atbildību paziņo par tālāk minēto izstrādājumu atbilstību  
deklareerib ainuvastutusel järgmiste toodete vastavust

Model: CIPR-GA70 □ □ □ □ □ □ □ □ - □ □ □ □ □ □

## Directive of the European Parliament and Council

Europa-Parlamentets og Rådets direktiv / EU-direktiv / Euroopan parlamentin ja neuvoston direktiivi  
Eiropas Parlamenta un Padomes Direktīva / Euroopa Parlamendi ja nõukogu direktiiv

### Low Voltage Directive (LVD)

Lavspændingsdirektivet / Lågspänningsdirektivet / Pienjännitedirektiivi  
Zemsprieguma direktīva / Madalpingedirektiiv

: 2014/35/EU

### Electromagnetic Compatibility Directive (EMC)

EMC-direktivet / EMC-direktivet / EMC-direktiivi  
EMS direktīva / Elektromagnetilise ühilduvuse direktiiv

: 2014/30/EU

### Machine Directive (MD)

Maskindirektivet / Maskindirektivet / Konedirektiivi  
Mašīnu direktīva / Masinadirektiiv

: 2006/42/EC

### Restriction of the use of certain hazardous substances (RoHS)

Om begrænsning af anvendelsen af visse farlige stoffer i elektrisk og elektronisk udstyr.  
Om begrænsning av användning av vissa farliga ämnen i elektrisk och elektronisk utrustning.  
Tiettyjen vaarallisten aineiden käyttöön rajoittamisesta sähkö- ja elektroniikkalaitteissa.  
Par dažu bīstamu vielu izmantošanas ierobežošanu elektriskās un elektroniskās iekārtās.  
Dēļ tam tikrų pavojingų medžiagų naudojimo elektros ir elektroninėje įrangoje apribojimo.

: 2011/65/EU

## Applied harmonized Standards:

EN 62061:2005/A1:2015 (SILCL3)  
EN ISO 13849-1:2015 (Cat.3, PL d)  
EN 61800-5-2:2007 (SIL3)  
EN 61800-5-1:2007

EN 50581:2012  
EN 61000-6-2:2005  
EN 61000-6-4:2007/A1:2011  
EN 61800-3:2004/A1:2012

## Place / Date

By, dato / Ort och datum / Paikka, pvm / Vieta, datums / Koht, kuupäev

**YASKAWA Europe GmbH**

Hauptstraße 185  
65760 Eschborn

March 23<sup>rd</sup> , 2018

General Manager  
European Technology Center  
Drives and Motion Division

  
Tobias Unger

# EU Declaration of Conformity

# YASKAWA

Translation - Croatian | Slovene | Maltese

## EZ Izjava o sukladnosti | Deklaracija o skladnosti ES Dikjarazzjoni tal-KE dwar il-Konformità

**YASKAWA Europe GmbH**  
Hauptstraße 185  
65760 Eschborn

### declares under sole responsibility conformity of the following products

pod isključivom odgovornošću izjavljuje sukladnost sljedećih proizvoda  
na lastno odgovornost potrjuje skladnost naslednjih izdelkov  
tiddikjara taft ir-responsabbiltà unika tagħha l-konformità tal-prodotti li għejjin

Model: CIPR-GA70 □ □ □□ □ □ □ □ - □□□□□□

### Directive of the European Parliament and Council

Direktiva Europskog parlamenta i Vijeća / Direktiva Evropskega parlamenta in Sveta  
Eiropas Parlamenta un Padomes Direktīva / Euroopa Parlamendi ja nõukogu direktiiv  
Direttiva tal-Parlament Ewropew u tal-Kunsill

#### Low Voltage Directive (LVD)

Direktiva o niskom naponu / Niskonapetostna direktiva  
Direttiva dwar il-Voltaġġ Baxx

: 2014/35/EU

#### Electromagnetic Compatibility Directive (EMC)

Direktiva o elektromagnetskoj kompatibilnosti (EMC) / EMC direktiva  
Direttiva dwar l-EMC

: 2014/30/EU

#### Machine Directive (MD)

Direktiva o strojevima / Direktiva o strojih  
Direttiva dwar il-Makkinarju (MD)

: 2006/42/EC

#### Restriction of the use of certain hazardous substances (RoHS)

O ograničenju uporabe određenih opasnih tvari u električnoj i elektroničkoj opremi.  
O omejevanju uporabe nekaterih nevarnih snovi v električni in elektronski opremi.  
Dwar ir-restrizzjoni tal-użu ta' ċerti sustanzi perikolużi fit-tagħmir elettriku u elettroniku.

: 2011/65/EU

#### Applied harmonized Standards:

EN 62061:2005/A1:2015 (SILCL3)  
EN ISO 13849-1:2015 (Cat.3, PL d)  
EN 61800-5-2:2007 (SIL3)  
EN 61800-5-1:2007

EN 50581:2012  
EN 61000-6-2:2005  
EN 61000-6-4:2007/A1:2011  
EN 61800-3:2004/A1:2012

#### Place / Date

Mjesto, datum / Kraj, datum / Post, Data

#### YASKAWA Europe GmbH

Hauptstraße 185  
65760 Eschborn

March 23<sup>rd</sup>, 2018

General Manager  
European Technology Center  
Drives and Motion Division

*Tobias Unger*  
Tobias Unger



# Q2A

## Driving Quality

### Installation & Operation Instructions

#### Omron Office Addresses

**OMRON EUROPE B.V.**

Tel: +31 (0) 23 568 13 00  
industrial.omron.eu

**Austria**

Tel: +43 (0) 2236 377 800  
industrial.omron.at

**Belgium**

Tel: +32 (0) 2 466 24 80  
industrial.omron.be

**Czech Republic**

Tel: +420 234 602 602  
industrial.omron.cz

**Denmark**

Tel: +45 43 44 00 11  
industrial.omron.dk

**Finland**

Tel: +358 (0) 207 464 200  
industrial.omron.fi

**France**

Tel: +33 (0) 1 56 63 70 00  
industrial.omron.fr

**Germany**

Tel: +49 (0) 2173 680 00  
industrial.omron.de

**Hungary**

Tel: +36 1 399 30 50  
industrial.omron.hu

**Italy**

Tel: +39 02 326 81  
industrial.omron.it

**Netherlands**

Tel: +31 (0) 23 568 11 00  
industrial.omron.nl

**Norway**

Tel: +47 (0) 22 65 75 00  
industrial.omron.no

**Poland**

Tel: +48 22 458 66 66  
industrial.omron.pl

**Portugal**

Tel: +351 21 942 94 00  
industrial.omron.pt

**Russia**

Tel: +7 495 648 94 50  
industrial.omron.ru

**South Africa**

Tel: +27 (0)11 579 2600  
industrial.omron.co.za

**Spain**

Tel: +34 902 100 221  
industrial.omron.es

**Sweden**

Tel: +46 (0) 8 632 35 00  
industrial.omron.se

**Switzerland**

Tel: +41 (0) 41 748 13 13  
industrial.omron.ch

**Turkey**

Tel: +90 212 467 30 00  
industrial.omron.com.tr

**United Kingdom**

Tel: +44 (0) 1908 258 258  
industrial.omron.co.uk

**More Omron representatives**

industrial.omron.eu

In the event that the end user of this product is to be the military and said product is to be employed in any weapons systems or the manufacture thereof, the export will fall under the relevant regulations as stipulated in the Foreign Exchange and Foreign Trade Regulations. Therefore, be sure to follow all procedures and submit all relevant documentation according to any and all rules, regulations and laws that may apply. Specifications are subject to change without notice for ongoing product modifications and improvements.

Original Instructions

© 2018 YASKAWA Europe GmbH

MANUAL NO. TOMP YEUOQ2A 03  
Revision A <1>-0  
March 2018  
Published in Germany

